



FULL MANUAL

VHF AIR BAND TRANSCEIVER

IC-A120 IC-A120E

INTRODUCTION

1 PANEL DESCRIPTION

2 BASIC OPERATION

3 SCAN OPERATION

4 MEMORY OPERATION

5 OTHER FUNCTIONS

6 Bluetooth® OPERATION

7 MENU MODE

8 CONNECTION AND INSTALLATION

9 SPECIFICATIONS AND OPTIONS

10 CI-V INFORMATION

INDEX

INTRODUCTION

FOREWORD

READ ALL INSTRUCTIONS carefully before using the IC-A120/IC-A120E VHF AIR BAND TRANSCEIVER.

KEEP THIS FULL MANUAL, because it contains important operating information that may be useful in the future.

The **BASIC MANUAL** is supplied with the transceiver.

Section 1 PANEL DESCRIPTION

Front panel.....	1-2
Function display.....	1-3

Front panel

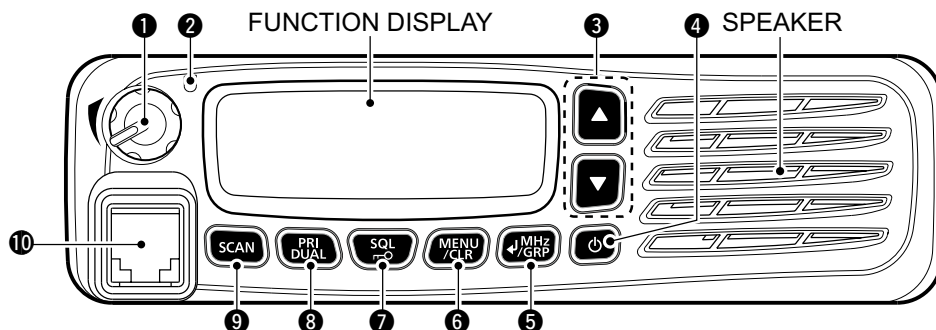

❶ VOLUME CONTROL KNOB

Adjusts the audio output level.

❷ STATUS INDICATOR

- Lights red while transmitting.
- Lights green while receiving.

❸ UP/DOWN KEYS [▲]/[▼]

Push to select an operating channel, frequency, and menu items.

❹ POWER KEY [⏻]

- Hold down for 1 second to turn the power ON or OFF.
- Push to exit the Menu mode.

❺ ENTER/MHz/GRP KEY [↵]/[MHz]/[GRP]

- Push to save entered data, a selected item, and so on in the Menu mode.
- Push to open the “MEMORY” menu in the Memory mode.
- Push to enter the MHz digit Selection mode in the VFO mode*.

* For only EXP, USA, and EUR versions.

❻ MENU/CLEAR KEY [MENU]/[CLR]

- Push to enter the Menu mode.
- Push to cancel entered data, or to return to the previous screen in the Menu mode.

❼ SQUELCH ADJUSTMENT/LOCK KEY [SQL]/[⏻]

- Push to open the squelch adjustment window (p. 2-3).
- Hold down for 1 second to turn the Key Lock function ON or OFF (p. 7-6).

❽ PRIORITY CHANNEL/DUALWATCH KEY [PRI]/[DUAL]

- Push to select the Priority channel.
- Hold down for 1 second to turn ON Dualwatch operation, push to turn it OFF.

❾ SCAN KEY [SCAN]

- Push to start or stop a scan.
- Hold down for 5 seconds to select whether or not to lockout the displayed channel (p. 7-3).

❿ MICROPHONE CONNECTOR

Connect the supplied or an optional microphone.

Function display

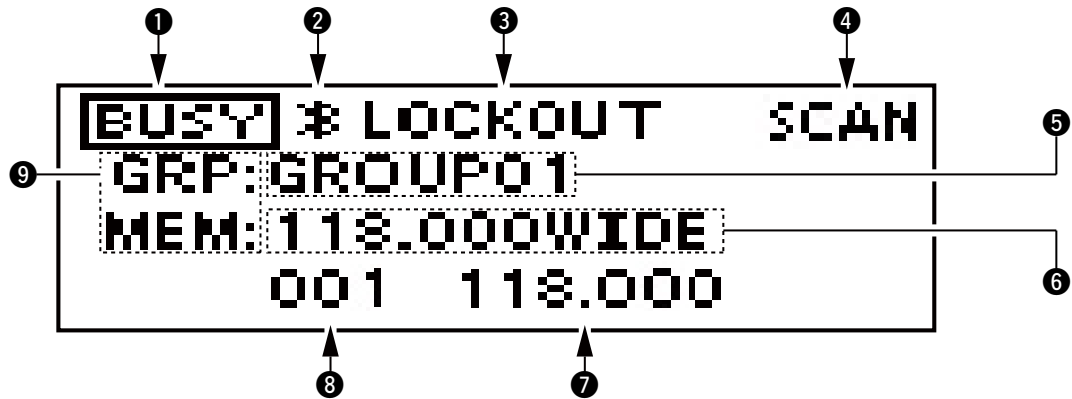

1 TX/BUSY ICON

- Displays “TX” while transmitting.
- Displays “BUSY” while receiving.

2 BLUETOOTH ICON

Displayed when a Bluetooth® headset is connected to the transceiver.

3 LOCKOUT ICON

Displayed when the selected channel is locked out.

4 SCAN/CHANNEL ICON

- Displays “SCAN” while scanning.
- Displays “PSCAN” while Priority scanning.
- Displays “CH XXX”^{*1} for 5 seconds when you change the channel in the Memory mode.

5 GROUP NAME READOUT

Displays the group name^{*2}.

6 MEMORY NAME READOUT

Displays the memory name if it is entered^{*2}.

7 FREQUENCY READOUT

Displays the operating frequency^{*2}.

8 CHANNEL READOUT

Displays the selected channel number^{*2}.

9 OPERATING MODE ICON

- Displays “MEM” in the Memory mode^{*2}.
- Displays “PRI” when the Priority channel is set in the Memory mode.
- Displays “VFO” in the VFO mode^{*3}.

^{*1} XXX represents the channel number.

^{*2} Displayed depending on the Indication Type setting in the Menu mode (p. 7-7).

^{*3} For only EXP, USA, and EUR versions.

Section 2 BASIC OPERATION

Turning ON the transceiver	2-2
◇ Entering the password	2-2
Receiving and transmitting	2-2
Adjusting the squelch	2-3

Turning ON the transceiver

Hold down [⏻] for 1 second to turn ON the power. If the transceiver is preset for a start-up password, enter the 6 digits password.



While in the Password Entry mode, "PASSWORD" is displayed.

◇ Entering the password

Enter the password in the following manner.

KEY	SCAN	PRI DUAL	SQL \overline{m} -O	MENU /CLR	↵/MHz/GRP
NUMBER	0	1	2	3	4
	5	6	7	8	9

Example:

If the password is 513824, push [SCAN], [PRI/DUAL], [MENU/CLR], [MENU/CLR], [SQL/ \overline{m} -O], and then push [↵/MHz/GRP].

- Note that each key represents 2 digits. That means, "123456" and "678901" are entered in exactly the same way (requires no multiple or extended pushing.)
- The entered password will not be displayed.
- If "PASSWORD" does not disappear after entering, the entered password is incorrect. Turn OFF the transceiver, and then try again.

Receiving and transmitting

1. Setting the frequency

Setting the frequency in the Memory mode

- 1) Open the "MEMORY" menu.
 - ➔ Push [↵/MHz/GRP].
- 2) Select "GROUPS" item.
 - ➔ Push [▲] or [▼], and then push [↵/MHz/GRP].



- 3) Select a desired group.
 - ➔ Push [▲] or [▼], and then push [↵/MHz/GRP].

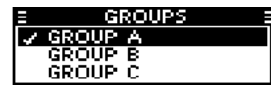

- 4) Select a desired channel.
 - ➔ Push [▲] or [▼].

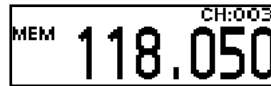

Setting the frequency in the VFO mode (For only EXP, USA, and EUR versions.)

- 1) Switch the transceiver to the VFO mode.
 - ➔ Select "VFO MODE" group in the Menu mode and then push [↵/MHz/GRP].

MENU > VFO MODE/MEMORY MODE

- 2) Set the MHz digit.
 - ➔ Push [↵/MHz/GRP], and then push [▲] or [▼].
 - The MHz digit blinks.
- 3) Exit the MHz digit Selection mode.
 - ➔ Push [↵/MHz/GRP] again.
- 4) Set the kHz digit.
 - ➔ Push [▲] or [▼].

TIP: You can select the channel spacing in the "CH SPACING" item*.



*The menu may not be displayed, depending on the transceiver's presettings. Ask your authorized Icom dealer or transceiver administrator for details.

CAUTION: In Canada, use of 8.33 kHz Channel Spacing of this radio is strictly prohibited and shall not be used.

Receiving and transmitting (Continued)

2. Receiving

When receiving a signal, "BUSY" is displayed and audio is heard.

- Rotate volume control knob to adjust the audio level.
- Adjust the squelch if necessary. See 'Adjusting the squelch' to the right for details.

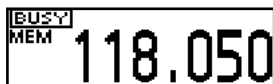

3. Transmitting

1) Hold down [PTT], and then speak at your normal voice level.

- "TX" is displayed.

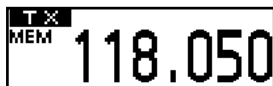

2) Release [PTT] to receive.

Information

To maximise the clarity of the signal, hold the microphone about 5 to 10 cm (2 to 4 inches) from your mouth.

Adjusting the squelch

Adjust the squelch to mute undesired noise when no signal is received.

- 1) Open the "SQL" window.
 - Push [SQL/↔].
- 2) Adjust the squelch.
 - Push [▲] or [▼] to select the desired squelch level.



Scan types.....	3-2
◇ Memory channel scan.....	3-2
◇ Priority scan	3-2
◇ VFO scan.....	3-2
Scan settings	3-2
◇ Selecting Scan types	3-2
◇ Setting the Resume timer	3-2
◇ On-Hook scan.....	3-2
◇ Setting the stop/TX channel.....	3-2

Scan types

The IC-A120/IC-A120E have different types of scan described below to search for signals.

NOTE: The Scan function may be disabled, depending on the transceiver's setting. Ask your authorized Icom dealer or transceiver administrator for details.

◇ Memory channel scan

Repeatedly scans memory channels belonging to the same group except locked out channels.

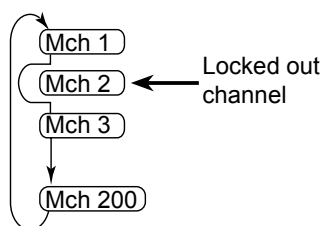

◇ Priority scan

While scanning the Memory channel, Priority watch checks for a signal on the selected Priority channel.

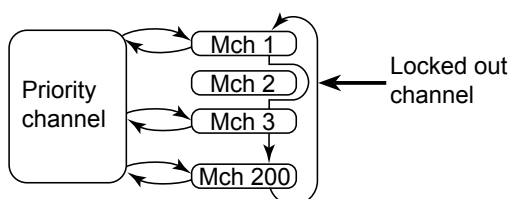

◇ VFO scan

(For only EXP, USA and EUR versions.)

Repeatedly scans all frequencies over the entire band.

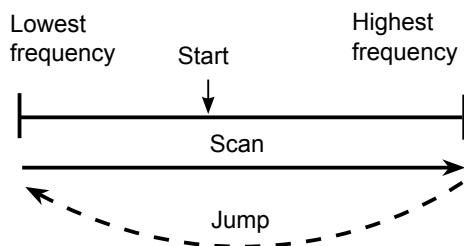

Scan settings

Customize the Scan settings in the Menu mode. When you push [SCAN], the transceiver starts scanning according to the settings described below.

◇ Selecting Scan types

Select the desired scan type in the "SCAN TYPE" item before scanning (p. 7-6).

MENU > SETTINGS > SCAN > **SCAN TYPE**



◇ Setting the Resume timer

Set the period of time to resume scanning after the receiving signal disappears (p. 7-6).

MENU > SETTINGS > SCAN > **RESUME TIMER**

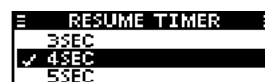

◇ On-Hook scan

The transceiver scans for signals while the microphone is on the hook, depending on the setting (p. 7-6).

MENU > SETTINGS > SCAN > **ON-HOOK SCAN**



◇ Setting the stop/TX channel.

Select the channel that the On-Hook scan stops on when you remove the microphone from the hook, and the channel to transmit on when you push [PTT] while the Dualwatch function is ON (p. 7-6).

MENU > SETTINGS > SCAN > **STOP/TX CH**



Section 4 MEMORY OPERATION

General description.....	4-2
Editing a Memory channel.....	4-2
◇ Editing the memory name.....	4-2
◇ Deleting a Memory channel.....	4-2
Entering contents into the Memory channels.....	4-3

General description

The IC-A120/IC-A120E has 200 memories to store frequently used channels. You can assign the stored channel to up to 10 groups.

Editing a Memory channel

You can edit pre-entered Memory channel contents, depending on the transceiver's presettings.

◇ Editing the memory name

To edit a memory name, follow the steps below.

1. Setting the frequency in the Memory mode

- 1) Open the "MEMORY" menu.
 - ➔ Push [↵/MHz/GRP].
- 2) Select "GROUPS" item.
 - ➔ Push [▲] or [▼], and then push [↵/MHz/GRP].
- 3) Select a desired group.
 - ➔ Push [▲] or [▼], and then push [↵/MHz/GRP].
- 4) Select a desired channel.
 - ➔ Push [▲] or [▼].

2. Editing the memory name

- 1) Open the "MEMORY NAME" item.

MENU > MEMORY MANAGE > EDIT > **MEMORY NAME**

- 2) Enter a desired name.
 - ➔ Push [▲] or [▼] to select the desired character.
 - Push [SCAN] to select the character group.
 - You can enter the characters listed below.

A to Z, a to z, 0 to 9, (space)
!"#\$%&'()*+,-./:;<=>@[\] ^ _ ` { } ~

- Push [MENU/CLR] to clear the entered character.
- Push [PRI/DUAL] to move the cursor to the left, and push [SQL] to move the cursor to the right.
- You can enter up to 12 characters.



- 3) Return to the "EDIT" menu.
 - ➔ Push [↵/MHz/GRP].
- 4) Save the entered name.
 - ➔ Select the "OVERWRITE" item and then push [↵/MHz/GRP].
 - The transceiver automatically exits the Menu mode.
 - The entered memory name is displayed.
 - If the memory name is not displayed, check the Indication Type setting in the Menu mode (p. 7-7).

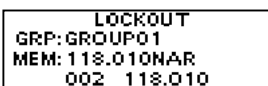

◇ Deleting a Memory channel

You can delete an unwanted memory channel.

1. Setting the frequency in the Memory mode

- 1) Open the "MEMORY" menu.
 - ➔ Push [↵/MHz/GRP].
- 2) Select "GROUPS" item.
 - ➔ Push [▲] or [▼], and then push [↵/MHz/GRP].
- 3) Select a desired group.
 - ➔ Push [▲] or [▼], and then push [↵/MHz/GRP].
- 4) Select a desired channel.
 - ➔ Push [▲] or [▼].

2. Deleting a Memory channel

Select the "DELETE" item and then push [↵/MHz/GRP].

MENU > MEMORY MANAGE > **DELETE**

Entering contents into the Memory channels

You can enter contents into the Memory channels in the VFO mode, depending on the transceiver's presets.

NOTE: The VFO mode is for only EXP, USA, and EUR versions. If you are using the transceiver without the VFO mode, you cannot enter the contents into memory channels.

1. Setting the frequency in the VFO mode

- 1) Set the MHz digit.
 - Push [↵/MHz/GRP], and then push [▲] or [▼].
 - The MHz digit blinks.
- 2) Exit the MHz digit Selection mode.
 - Push [↵/MHz/GRP] again.
- 3) Set the kHz digit.
 - Push [▲] or [▼].

2. Entering a memory name (p. 7-3)

- 1) Open the "MEMORY NAME" item.

MENU > MEMORY WRITE > **MEMORY NAME**
- 2) Enter a desired name.
 - Push [▲] or [▼] to select the desired character.
 - Push [SCAN] to select the character group.
 - You can enter the characters listed below.

A to Z, a to z, 0 to 9, (space)
! " # \$ % & ' () * + , - . / : ; < = > ? @ [\] ^ _ ` { } ~

 - Push [MENU/CLR] to clear the entered character.
 - Push [PRI/DUAL] to move the cursor to the left, and push [SQL] to move the cursor to the right.
 - You can enter up to 12 characters.
- 3) Return to the "MEMORY WRITE" menu.
 - Push [↵/MHz/GRP].

3. Setting the Lockout setting (p. 7-3)

Select whether or not to lockout the selected channel while scanning.

- 1) Open the "LOCKOUT" item.
 - Push [▲] or [▼], and then [↵/MHz/GRP].
- 2) Select the Lockout setting for the channel.
 - Select "OFF" or "ON" and then push [↵/MHz/GRP].
 - Returns to the "MEMORY WRITE" menu.

4. Selecting a group (p. 7-3)

Select the group to store the selected channel in. You can select one of up to 10 groups, depending on the transceiver's setting.

- 1) Open the "GROUP" item.
 - Push [▲] or [▼], and then [↵/MHz/GRP].
 - The group list is displayed.
- 2) Select a desired group.
 - Push [▲] or [▼], and then [↵/MHz/GRP].
 - Returns to the "MEMORY WRITE" menu.

5. Writing the contents into the Memory channel

Select the "WRITE" item and then push [↵/MHz/GRP].

Section 5 OTHER FUNCTIONS

Priority channel	5-2
◇ Setting the Priority channel	5-2
Dualwatch operation	5-2

Priority channel

The Priority channel enables you to have quick access to a specific channel. You can set one of the Memory channels as the Priority channel.

NOTE: The Priority channel may be disabled, depending on the transceiver's setting. Ask your authorized Icom dealer or transceiver administrator for details.

◇ Setting the Priority channel

1) Open the "PRIORITY CH" menu.

MENU > SETTINGS > FUNCTIONS > **PRIORITY CH**

- The channel set as the Priority channel is displayed.
- "OFF" is displayed if no channel is set as the Priority channel.



2) Open the "GROUP" menu.

➔ Push [↵/MHz/GRP].

3) Select the desired group.

➔ Push [▲] or [▼] and then push [↵/MHz/GRP].

4) Select the desired channel.

➔ Push [▲] or [▼] and then push [↵/MHz/GRP].

- "Returns to the "PRIORITY CH" menu.
- "The selected channel is displayed as the Priority channel.



Dualwatch operation

Dualwatch monitors the Priority channel while a VFO* or Memory channel is selected.

If a signal is received on the Priority channel, Dualwatch changes to the Priority channel until the Priority signal disappears. Dualwatch then returns to the selected other channel.

*For only EXP, USA, and EUR versions.

Hold down [PRI/DUAL] for 1 second to turn ON the Dualwatch function.

- The Priority channel is displayed under the selected channel.
- The Priority channel's name may be displayed, depending on the Indication Type setting. See page 7-7 for details.

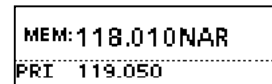

- When a signal is received on the Priority channel, "PRI" blinks and the Priority channel is displayed larger than the selected channel.

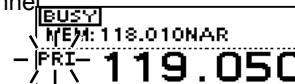

- If the "STOP/TX CH" item's setting in the menu mode (p. 7-6) is set to "PRIORITY CH," "TX:PRI" is displayed as shown below.

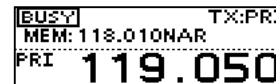

Section 6 Bluetooth® OPERATION

Operating Bluetooth®	6-2
Electromagnetic interference	6-2
Pairing with a headset.....	6-3
Connecting a paired headset	6-3
Setting AF output	6-3
Disconnecting a headset	6-4
Unpairing a headset	6-4

Operating Bluetooth®

If the UT-133A Bluetooth® UNIT is installed in the transceiver, you can connect a Bluetooth® headset.

When you connect the VS-3 Bluetooth® HEADSET to the transceiver, you can wirelessly transmit and receive the headset audio. The VS-3 has a [PTT] switch, so you can transmit in the same way as using the transceiver's [PTT] switch.

Communication range of Bluetooth® is approximately 10 meters (32.8 ft).

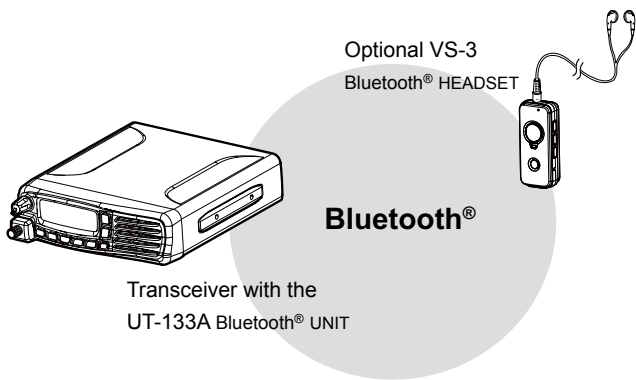

Electromagnetic interference

When you use a Bluetooth® headset, pay attention to the following:
Bluetooth® devices operate in the 2.4 GHz band. The 2.4 GHz band is also used by other devices, such as Wireless LAN products, microwave ovens, RFID systems, amateur radio stations, and so on. When using the Bluetooth® headset near such devices, interference may occur, causing a decrease in communication speed, and an unstable connection. In such cases, use the headset away from the other devices, or stop using those headsets.

The Bluetooth® communication range may vary, depending on your operating environment. Microwave ovens or Wireless LANs may cause interference. In that case, stop using those devices or move away from them. This Bluetooth® headset has a usable range. If communication is unstable, move within the range.

Pairing with a headset

These instructions describe pairing with the VS-3 Bluetooth® HEADSET. You can pair a maximum of 7 Bluetooth® headsets with the transceiver.

- If you try to pair a Bluetooth® headset to a transceiver that already has 7 headsets paired with it, the oldest headset will automatically be unpaired.

1. Turning ON transceiver's Bluetooth® function

- 1) Open the "BLUETOOTH FUNC" item.

MENU > SETTINGS > BLUETOOTH
> **BLUETOOTH FUNC**

- 2) Activate the Bluetooth® unit.
 - ➔ Select "ON" and push [↔/MHz/GRP].

2. Entering the Pairing mode of the VS-3

- See the VS-3's instruction manual for details.

3. Pairing the Bluetooth® headset

- 1) Open the "DEVICE SEARCH" item.

MENU > BLUETOOTH > PAIR/CONNECT
> **DEVICE SEARCH**

- 2) Search for a headset to pair.
 - ➔ Select "HEADSET" and push [↔/MHz/GRP].
 - The found headsets are displayed.
 - "NOT FOUND" is displayed if no headset is found.
 - Push [MENU/CLR] to cancel searching.
 - The headset name changes to its Bluetooth® device address in 5 seconds.

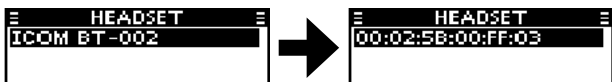

- 3) Select the desired headset to pair.
 - ➔ Push [▲] or [▼] and then push [↔/MHz/GRP].
 - A passkey or PIN code may be required to pair, depending on the headset. Refer to your headset's instructions for details.
- 4) Exit the Menu mode.
 - ➔ Push [⏏].
 - "☒" is displayed if the headset is correctly paired.

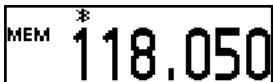

Connecting a paired headset

If you have a previously paired headset, follow the steps below to connect it.

- 1) Open the "PAIR/CONNECT" menu.

MENU > BLUETOOTH > **PAIR/CONNECT**

- The paired headsets are displayed.
- 2) Select the desired headset to connect.
 - ➔ Push [▲] or [▼] and then push [↔/MHz/GRP].
 - "CONNECT" and "UNPAIR" is displayed.
 - 3) Connect the headset.
 - ➔ Select "CONNECT" and then push [↔/MHz/GRP].
 - The check mark "☑" in the box is displayed.



- 4) Exit the Menu mode.
 - ➔ Push [⏏].

Setting AF output

You can select the AF output option in the "AF OUTPUT" item.

MENU > SETTINGS > BLUETOOTH
> HEADSET SET > **AF OUTPUT**



- HEADSET: Outputs audio to the connected Bluetooth® headset.
- HEADSET & SPEAKER: Outputs audio to both the connected Bluetooth® headset and the transceiver's speaker.

Disconnecting a headset

You can disconnect a headset without canceling the pairing.

- 1) Open the "PAIR/CONNECT" menu.
MENU > BLUETOOTH > **PAIR/CONNECT**
 - The connected headsets are displayed.
- 2) Select the desired headset to disconnect.
 - Push [▲] or [▼] and then push [↔/MHz/GRP].
 - "DISCONNECT" is displayed.
- 3) Disconnect the headset.
 - Push [↔/MHz/GRP], and then select [YES].
 - The check mark "✓" in the box disappears.



- 4) Exit the Menu mode.
 - Push [⏻].

Unpairing a headset

You can unpair a Bluetooth® headset. Before unpairing a connected headset, disconnect it.

- 1) Open the "PAIR/CONNECT" menu.
MENU > BLUETOOTH > **PAIR/CONNECT**
 - The paired headsets are displayed.
- 2) Select the desired headset to unpair.
 - Push [▲] or [▼] and then push [↔/MHz/GRP].
- 3) Unpair the headset.
 - Select "UNPAIR" and push [↔/MHz/GRP].
 - The headset name disappears from the "PAIR/CONNECT" menu.



- 4) Exit the Menu mode.
 - Push [⏻].

Using the Menu mode	7-2
Menu mode items	7-3
VFO MODE/MEMORY MODE group	7-3
MEMORY WRITE group.....	7-3
◇ MEMORY NAME	7-3
◇ LOCKOUT.....	7-3
◇ GROUP.....	7-3
◇ GROUP NAME	7-3
◇ WRITE	7-3
MEMORY MANAGE group	7-4
EDIT	7-4
◇ MEMORY NAME	7-4
◇ LOCKOUT.....	7-4
◇ GROUP NAME	7-4
◇ OVERWRITE	7-4
DELETE	7-4
BLUETOOTH group	7-4
PAIR/CONNECT	7-4
◇ DEVICE SEARCH.....	7-4
PAIRING STANDBY.....	7-4
SETTINGS group	7-5
FUNCTIONS	7-5
◇ CH SPACING	7-5
◇ PRIORITY CH.....	7-5
◇ NOISE LIMITING	7-5
◇ TIME OUT TIMER.....	7-5
◇ MIC KEY CUSTOMIZE	7-5
◇ LOCK FUNCTION.....	7-6
◇ CI-V.....	7-6
SCAN	7-6
◇ SCAN TYPE.....	7-6
◇ RESUME TIMER	7-6
◇ ON-HOOK SCAN	7-6
◇ STOP/TX CH	7-6
DISPLAY.....	7-7
◇ LCD BACKLIGHT	7-7
◇ LCD CONTRAST	7-7
◇ INDICATION TYPE	7-7
SOUNDS.....	7-7
◇ KEY BEEP	7-7
◇ BEEP LEVEL	7-7
◇ SIDE TONE.....	7-7
◇ SPEAKER OUTPUT	7-7
BLUETOOTH.....	7-8
◇ BLUETOOTH FUNC.....	7-8
◇ AUTO CONNECT	7-8
◇ HEADSET SET	7-8
◇ DATA DEVICE SET.....	7-9
◇ DEVICE INFO	7-9
◇ DEVICE INITIALIZE.....	7-9
INFORMATION	7-9
◇ VERSION.....	7-9

Using the Menu mode

The Menu mode allows you to set seldom-changed settings. You can customize the transceiver settings to suit your preferences and operating style.

Example: Turning OFF the key beep.

- 1) Enter the Menu mode.
 - ➔ Push [MENU/CLR].

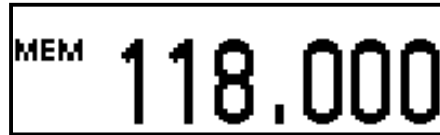

- 2) Open the "SETTINGS" group.
 - ➔ Push [▲] or [▼], and then push [↔/MHz/GRP].



- 3) Open the "SOUNDS" menu.
 - ➔ Push [▲] or [▼], and then push [↔/MHz/GRP].



- 4) Open the "KEY BEEP" item.
 - ➔ Push [▲] or [▼], and then push [↔/MHz/GRP].



- 5) Select OFF.
 - ➔ Push [▲] or [▼], and then push [↔/MHz/GRP].



- 6) Exit the Menu mode.
 - ➔ Push [⏻].

Menu mode items

The menu items contained in the transceiver may be different, depending on the transceiver's setting. Ask your dealer or transceiver administrator for details.

VFO MODE/MEMORY MODE group

(For only EXP, USA, and EUR versions.)

Switch the transceiver to the VFO mode or Memory mode.

Displays "VFO MODE" group when the transceiver is in the Memory mode, and displays "MEMORY MODE" group when the transceiver is in the VFO mode.



In the Memory mode



In the VFO mode

MEMORY WRITE group

(May not be displayed, depending on the transceiver's presets.)

◇ MEMORY NAME

Enter the memory name when you enter the frequency in the Memory channel.

You can enter the characters listed below.

A to Z, a to z, 0 to 9, (space)
!"#\$%&'()*+,-./:;<=>?@[\\]^_`{ }~

◇ LOCKOUT

Select whether or not to lockout the selected channel while scanning.

- OFF: The channel will not be locked out while scanning.
- ON: The channel will be locked out while scanning.

◇ GROUP

Select the group to store the selected channel in.

You can select one of up to 10 groups, depending on the transceiver's setting.

◇ GROUP NAME

Enter a group name of up to 12 characters.

You can enter the characters listed below.

A to Z, a to z, 0 to 9, (space)
!"#\$%&'()*+,-./:;<=>?@[\\]^_`{ }~

◇ WRITE

Save the entered settings in the MEMORY WRITE group items.

MEMORY MANAGE group

(May not be displayed, depending on the transceiver's presets.)

■ EDIT

◇ MEMORY NAME

Edit a selected Memory channel's name. You can enter the characters listed below.

A to Z, a to z, 0 to 9, (space)
!"#\$%&'()*+,-./:;<=>?@[\\]^_`{ }~

◇ LOCKOUT

Select whether or not to lock out the selected channel while scanning.

- OFF: The channel will not be locked out while scanning.
- ON: The channel will be locked out while scanning.

◇ GROUP NAME

Edit a Group name. You can enter the characters listed below.

A to Z, a to z, 0 to 9, (space)
!"#\$%&'()*+,-./:;<=>?@[\\]^_`{ }~

◇ OVERWRITE

Save the edited settings in the MEMORY MANAGE group items.

■ DELETE

Delete a selected Memory channel.

BLUETOOTH group

(Displayed only when the optional UT-133A Bluetooth® UNIT is installed.)

■ PAIR/CONNECT

Displays the paired Bluetooth® headsets and devices.

◇ DEVICE SEARCH

Search for a Bluetooth® headset or a Bluetooth® data device to pair and connect.

- HEADSET: Search for a Bluetooth® headset.
- DATA DEVICE: Search for a Bluetooth® data device.

■ PAIRING STANDBY

Wait for the pairing request from a Bluetooth® headset or a Bluetooth® data device.

SETTINGS group

FUNCTIONS

◇ CH SPACING

(May not be displayed, depending on the transceiver's presets.)

Select "8.33 kHz," "25 kHz," or "8.33 kHz/25 kHz" channel spacing.

CAUTION: In Canada, use of 8.33 kHz Channel Spacing of this radio is strictly prohibited and shall not be used.

◇ PRIORITY CH

(May not be displayed, depending on the transceiver's presets.)

Select the Priority channel from the Memory channels stored in the transceiver (p. 5-2).

- The channel set as the Priority channel is displayed.
- "OFF" is displayed if no channel is set as the Priority channel.

◇ NOISE LIMITING

Set the noise limiting function for receiving and transmitting.

○ RX

- OFF: The Noise Limiting function is OFF.
- ANL: The Automatic Noise Limiter (ANL) is ON.
- LOW: Reduces the received signal noise level to 1/2 of normal.
- MID: Reduces the received signal noise level to 1/3 of normal.
- HIGH: Reduces the received signal noise level to 1/10 of normal.

○ TX

- OFF: The Noise Limiting function is OFF.
- ON: The Noise Limiting function is ON.

◇ TIME OUT TIMER

(May not be displayed, depending on the transceiver's presets.)

The Time-out Timer (TOT) limits continuous transmissions on the channel, to prevent occupying the channel for a long time.

- OFF*1: The Time-out Timer is disabled.
- 30 sec to 180 sec: Sets the Time-out Timer to between 30 seconds and 180 seconds.

*1 Except IC-A120E (AUS version).

◇ MIC KEY CUSTOMIZE

(May not be displayed, depending on the transceiver's presets.)

You can customize the key assignment for the optional HM-217 SPEAKER MICROPHONE (p. 9-3).

○ [P1]/[P2]

- VFO/MR MODE*2: Push to change the operating mode.
- PRIORITY CH: Push to select the Priority channel.
- DUALWATCH: Push to check the Priority channel while receiving another channel.
- SCAN START/PAUSE: Push to start a scan. Push again to pause the scan.
- SQL: Push to adjust the squelch. (p. 2-3)
- VOL: Push to adjust the volume.
- LOCK: Push to turn the Key Lock function ON or OFF.
- ---: No function is assigned.

*2 For only USA, EXP and EUR versions.

○ [UP]/[DOWN]

- UP/DOWN: Push to select the channel.
- VOL UP/DOWN: Push to adjust the volume level.
- SQL UP/DOWN: Push to adjust the squelch level.
- ---: No function is assigned.

◇ LOCK FUNCTION

Select an option for the Key Lock function.

- All: Locks all keys.
- Microphone Key: Locks the keys on the microphone.
- Panel Key: Locks the keys on the transceiver.

SETTINGS group

■ Functions (Continued)

◇ CI-V

(May not be displayed, depending on the transceiver's presets.)

○ CI-V address

To distinguish equipment, each CI-V transceiver has its own Icom standard address in hexadecimal code. The IC-A120/IC-A120E's default address is 92. When 2 or more transceivers are controlled through a PC at the same time, set a different address for each transceiver.

○ CI-V baud rate

Set the CI-V data transfer speed.

- 4800 BPS to 19200 BPS: Sets the data transfer speed to between 4800 bps and 19200 bps.
- AUTO: The baud rate is automatically set according to the data rate of the controller.

○ CI-V transceive

Turn the CI-V Transceive function ON or OFF.

- OFF: Turns OFF the function.
- ON: When you change a setting on one transceiver, the same setting is automatically changed on other connected transceivers.

■ SCAN

◇ SCAN TYPE

(May not be displayed, depending on the transceiver's presets.)

Select the scan type. When you push [SCAN], the scan proceeds according to this setting.

- NORMAL: Push [SCAN] to start a Normal scan.
- PRIORITY: Push [SCAN] to start a Priority scan.

◇ RESUME TIMER

(May not be displayed, depending on the transceiver's presets.)

When a received signal disappears, the scan resumes according to this setting. Set the Resume Timer to between 3 seconds and 10 seconds.

◇ ON-HOOK SCAN

(May not be displayed, depending on the transceiver's presets.)

Set the On-Hook scan function (p.3-2) to ON or OFF.

- OFF: The On-Hook scan function is OFF.
- ON: The On-Hook scan function is ON.

◇ STOP/TX CH

(May not be displayed, depending on the transceiver's presets.)

Select the channel that On-Hook scan stops on when you remove the microphone from the hook, and the channel to transmit on when you push [PTT] in Dualwatch operation.

- SCAN CH: The displayed channel is used as the scan stop channel during an On-Hook scan, and as the transmit channel.
- PRIORITY CH: The Priority channel is used as the scan stop channel during an On-Hook scan, and as the transmit channel.

SETTINGS group (Continued)

■ DISPLAY

◇ LCD BACKLIGHT

Sets the LCD backlight brightness level to between 0 and 3.

◇ LCD CONTRAST

Sets the LCD contrast level to between 1 and 10.

◇ INDICATION TYPE

Select the indication type for Function display in the Memory mode.

- **FREQ:** Displays frequency on the Function display.
- **NAME:** Displays channel name on the Function display.
- **FREQ & NAME:** Displays frequency and channel name on the Function display.

■ SOUNDS

◇ KEY BEEP

Set the key beep to ON or OFF.

- **OFF:** The key beep is OFF.
- **ON:** The key beep is ON.

◇ BEEP LEVEL

Sets the beep level to between 1 and 10 or OFF.

◇ SIDE TONE

The Side tone function outputs the transmitting audio to the VS-3 Bluetooth® HEADSET or the headset connected to the transceiver with OPC-871A HEADSET ADAPTER.

Sets the Side tone level to between 1 and 10 or OFF.

◇ SPEAKER OUTPUT

Select the speaker output setting.

- **OFF:** No audio is heard from any speaker.
- **AUTO:** If an external speaker is connected to the transceiver, the audio is heard from the external speaker.
If an external speaker is not connected to the transceiver, the audio is heard from the internal speaker.
- **INTERNAL:** The audio is heard from only the Internal speaker.
- **EXTERNAL:** The audio is heard from only the External speaker.
- **INT & EXT:** The audio is heard from both the internal speaker and the external speaker.

SETTINGS group (Continued)

■ BLUETOOTH

The items in the “BLUETOOTH” menu are displayed only when the UT-133A Bluetooth® UNIT is installed.

◇ BLUETOOTH FUNC

Turn the Bluetooth® function ON or OFF.

- OFF: The Bluetooth® function is OFF.
- ON: The Bluetooth® function is ON.

◇ AUTO CONNECT

(May not be displayed, depending on the transceiver’s presets.)

Select whether or not to automatically connect to the last bonded Bluetooth® headset.

- OFF: The user has to manually connect to the Bluetooth® headset.
- ON: The transceiver automatically connects to the last bonded Bluetooth® headset.

◇ HEADSET SET

○ AF OUTPUT

Select the AF output option.

- HEADSET: Outputs audio to the Bluetooth® headset.
- HEADSET & SPEAKER: Outputs audio to both the Bluetooth® headset and the internal speaker.

○ BT HEADSET USE

(May not be displayed, depending on the transceiver’s presets.)

Select which device’s audio and PTT to use when a Bluetooth® headset and the microphone are connected to the transceiver.

- NORMAL: Transmits the audio from the device whose [PTT] is pushed.
- MIC: Transmits the audio from the Bluetooth® headset.
- PTT (MAIN MIC): The transmission is made by pushing [PTT] on the Bluetooth® headset. Transmits the audio from the hand microphone.
- PTT (MAIN HS MIC): The transmission is made by pushing [PTT] on the Bluetooth® headset. Transmits the audio from the headset connected to the transceiver with the optional OPC-871A HEADSET ADAPTER.

○ ICOM HEADSET

(May not be displayed, depending on the transceiver’s presets.)

POWER SAVE:

Select whether or not to use the Battery Saving mode with VS-3 Bluetooth® HEADSET.

- OFF: The Power Save mode is OFF.
- ON: The Power Save mode is temporarily activated if the connected VS-3 Bluetooth® HEADSET is not used for 120 seconds.

ONE-TOUCH PTT:

This function enables you to communicate with a single push of the VS-3 Bluetooth® HEADSET’s [PTT]. Select whether or not to enable the One-Touch PTT function.

- OFF: The function is OFF.
- ON: The function is ON.

PTT BEEP:

Set the beep sound when pushing [PTT] on the optional VS-3 Bluetooth® HEADSET.

- OFF: No beep sounds when you push VS-3’s [PTT].
- ON: Beep sounds when you push VS-3’s [PTT].

SETTINGS group (Continued)

◇ **DATA DEVICE SET**

(May not be displayed, depending on the transceiver's presettings.)

○ **BT CI-V**

Select whether or not to send back the serial data received from the Bluetooth® SPP (Serial Port Profile) on a connected device when sending or receiving a CI-V command.

- ECHO BACK OFF: The serial data will not be send back.
- ECHO BACK ON: The serial data will be sent back.

◇ **DEVICE INFO**

Displays the information of the UT-133A Bluetooth® UNIT. You can edit the unit's name.

- Push [↵]/[MHz]/[GRP] to edit the unit's name.



◇ **DEVICE INITIALIZE**

(May not be displayed, depending on the transceiver's presettings.)

Initialize the UT-133A Bluetooth® UNIT, and then reboot the transceiver.

■ **INFORMATION**

◇ **VERSION**

Displays your transceiver's firmware version number.

Section 8

CONNECTION AND INSTALLATION

Rear panel connection.....	8-2
Mounting the transceiver.....	8-3
Supplied accessories.....	8-4

Rear panel connection

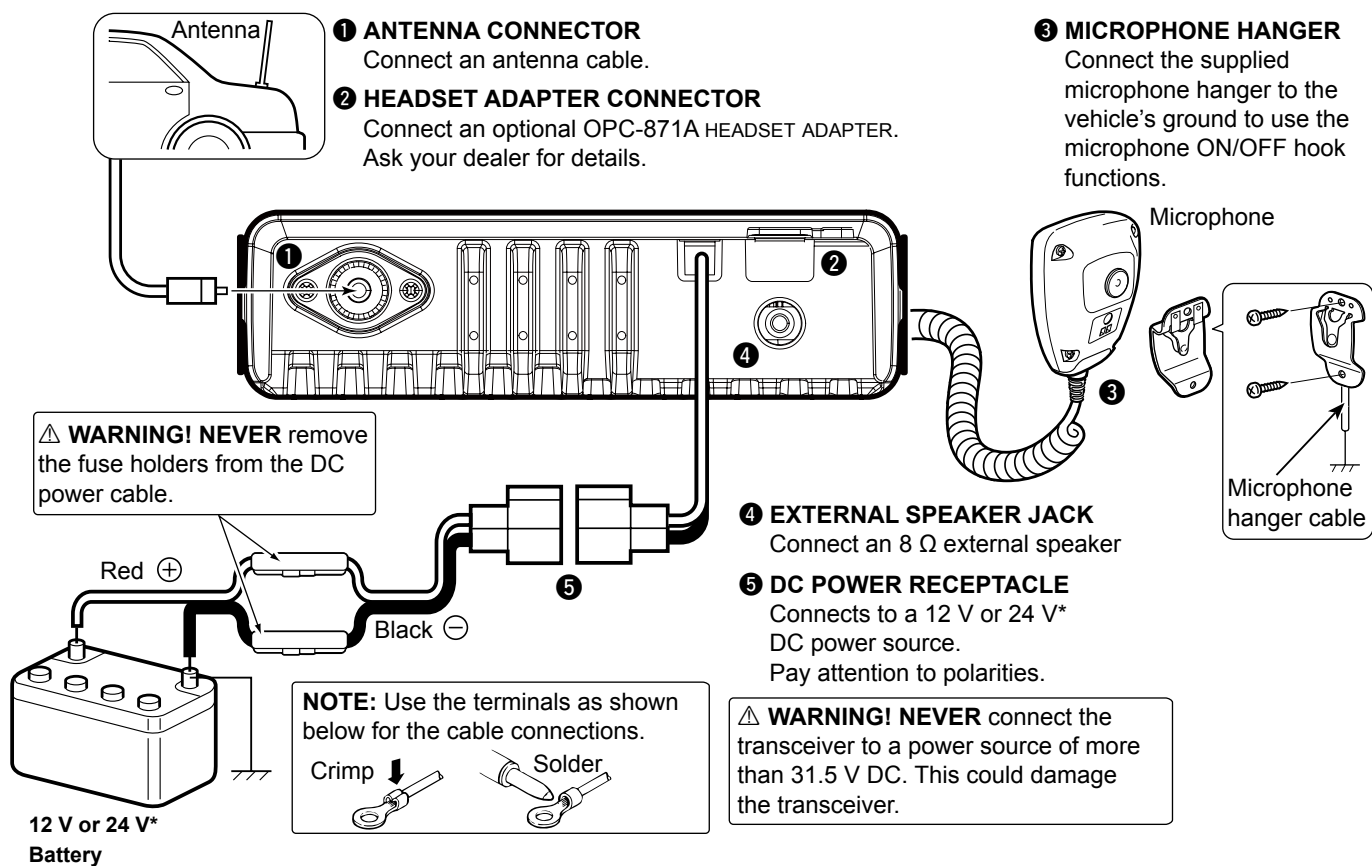

*The transceiver automatically adjusts to the input voltage.

Mounting the transceiver

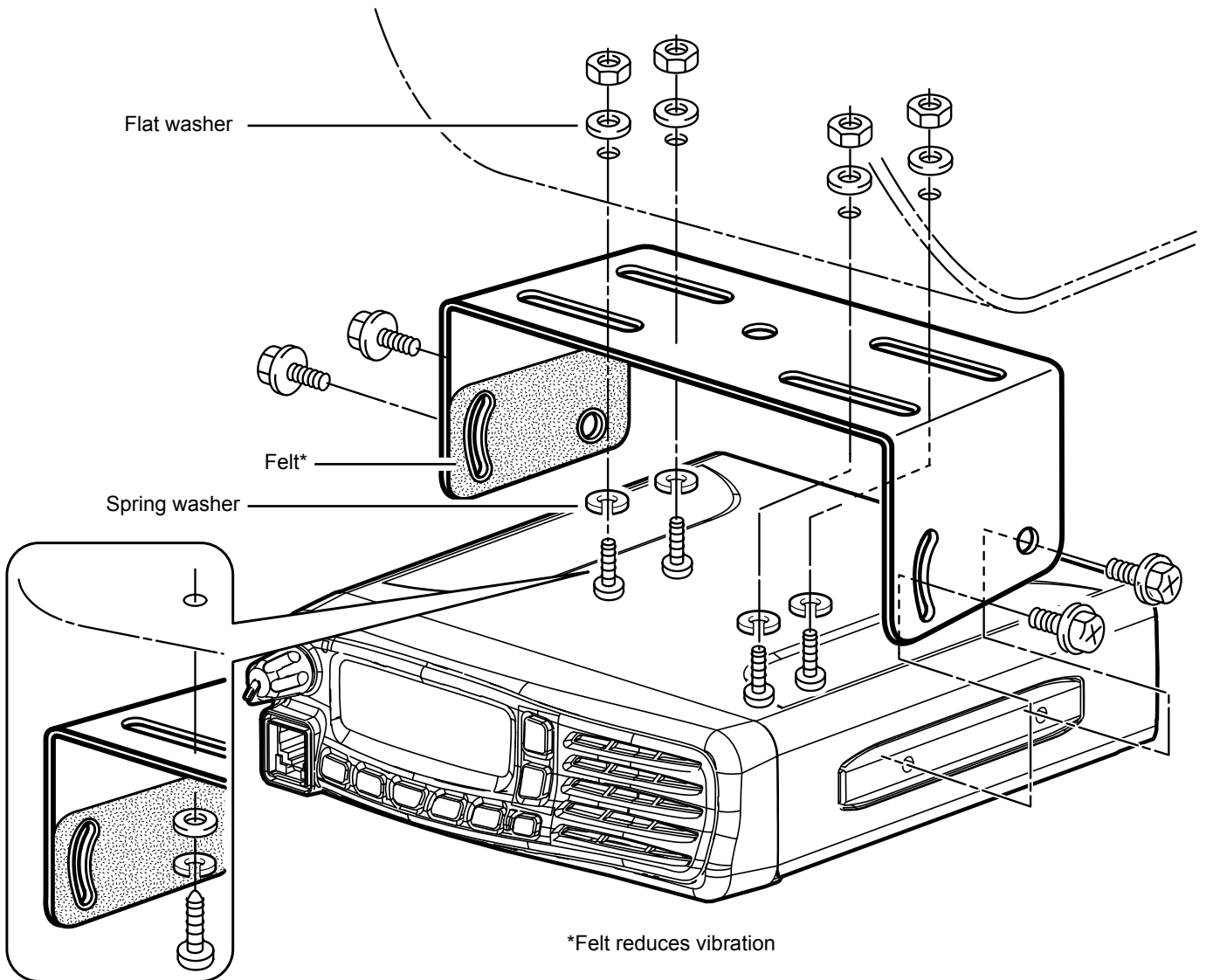

When using
self-tapping screws

Supplied accessories

Microphone

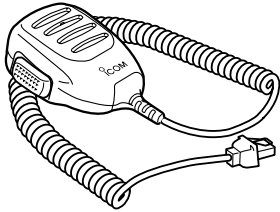

Microphone hanger

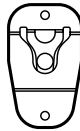

Microphone hanger cable



DC power cable

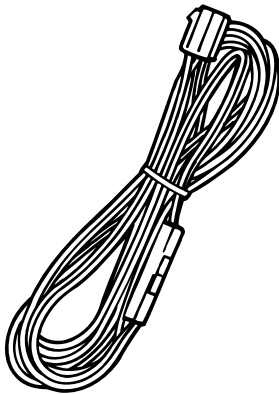

Mounting bracket

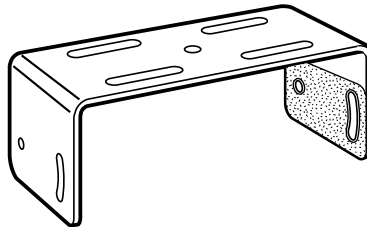

Sponges*

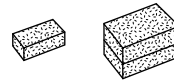

Flat washers



Bracket bolts



Self-tapping screws (5×16)

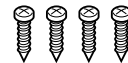

Spring washers



Mounting screws (5×12)



Self-tapping screws (3×16, for Microphone hanger)



Nuts



Fuses (10 A)

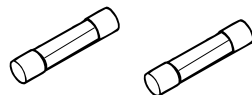

* Used to install the optional UT-133A Bluetooth® UNIT.
Ask your dealer for details.

Section 9

SPECIFICATIONS AND OPTIONS

Specifications	9-2
◇ General	9-2
◇ Transmitter	9-2
◇ Receiver	9-3
Options	9-3

Specifications

In Canada, Use of 8.33 kHz Channel Spacing of this radio is strictly prohibited and shall not be used.

◇ General

- Frequency range:
 - IC-A120 118.000 to 136.99166 MHz
 - IC-A120E (AUS version) 118.000 to 136.97500 MHz
 - IC-A120E (Others) 118.000 to 136.99166 MHz
- Channel spacing: 25 kHz/8.33*¹ kHz
- Type of emission:
 - IC-A120 6K00A3E/5K60A3E (FCC/EXP)
6K00A3E (Industry Canada)
 - IC-A120E 6K80A3E/5K00A3E*¹
- Number of memory channels: 200
- Antenna impedance: 50 Ω (nominal)
- Antenna connector: SO-239
- Power supply requirement: 13.75 V/27.5 V DC (negative ground)
- Current drain (at 13.75 V):
 - TX 5.0 A
 - Maximum audio 4.0 A
- Operating temperature range:
 - IC-A120 -30°C to +60°C,
-22°F to +140°F
 - IC-A120E (AUS version) -10°C to +60°C
 - IC-A120E (Others) -20°C to +55°C
- Dimensions:
 - (projections not included) 161 (W)×45 (H)×175 (D) mm,
6.3 (W)×1.8 (H)×6.9 (D) inches
- Weight (approximately): 1.5 kg, 3.3 lb

*¹ Except IC-A120E (AUS version).

◇ Transmitter

- Output power:
 - IC-A120 9 W (Carrier power) typical
10 W (Carrier power) maximum
 - IC-A120E 9 W±1.5 dB (+15°C to +35°C)
9 W+1.5 dB/-3dB (-20°C to +55°C)
- Frequency stability:
 - IC-A120 ±5 ppm (-30°C to +60°C, -22°F to +140°F)
 - IC-A120E ±1 ppm (0°C to +40°C)
- Modulation system: Last stage modulations
- Audio frequency distortion:
 - IC-A120 Less than 10% (at 70% modulation)
 - IC-A120E Less than 10% (at 85% modulation +3 dB)
- Spurious emissions:
 - IC-A120 Less than -60 dBc
 - IC-A120E*²
 - 9 kHz to 30 MHz Less than -46 dBm
 - 30 MHz to 1 GHz Less than -36 dBm (For Harmonics)
Less than -46 dBm (For Non-Harmonics)
 - 1 GHz to 4 GHz Less than -30 dBm (For Harmonics)
Less than -40 dBm (For Non-Harmonics)

*² Except for operating frequency ±1 MHz.

Specifications (Continued)

◇ Receiver

- Receive system: Double conversion superheterodyne
- Intermediate frequencies: 1st 38.85 MHz
2nd 450 kHz
- Sensitivity:
 - IC-A120 Less than 1 μ V (pd) (at 6 dB S/N)
 - IC-A120E Less than -101 dBm (12 dB SINAD with CCITT)
- Squelch sensitivity:
 - IC-A120 Less than 0.35 μ V (pd)
 - IC-A120E Less than -116 dBm
- Spurious response rejection ratio:
 - IC-A120 More than 5 mV (pd)
 - IC-A120E More than 70 dB
- Audio output power:
 - External speaker More than 10 W
(at 13.75 V DC with 8 Ω load 60% mod, 10% distortion)
 - Side tone More than 100 mW
(at 13.75 V DC with 500 Ω load 60% mod, 10% distortion)

All stated specifications are subject to change without notice or obligation.

Options

HM-217 SPEAKER MICROPHONE

The speaker microphone with [▲]/[▼] keys and [P1]/[P2] keys.

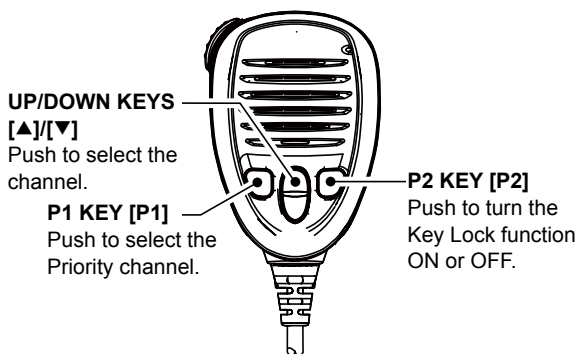

You can customize the key assignment in the Menu mode (p. 7-5).

VS-3 Bluetooth® HEADSET

The Bluetooth® headset with a [PTT] switch.

UT-133A Bluetooth® UNIT

OPC-871A HEADSET ADAPTER

The adapter to connect a standard headset.

OPC-478UC CLONING CABLE

The cable to connect a PC and the OPC-592 CLONING CABLE ADAPTER when you control the transceiver with the CI-V commands (p. 10-2).

OPC-592 CLONING CABLE ADAPTER

The cable adapter to connect the transceiver and the OPC-478UC CLONING CABLE when you control the transceiver with the CI-V commands (p. 10-2).

Section 10 CI-V INFORMATION

CI-V data setting	10-2
CI-V connection example	10-2
Data format	10-2
Command table	10-3
◇ Operating frequency setting.....	10-3
◇ Operating mode setting.....	10-3
◇ Squelch setting	10-4

CI-V data setting

You can control the transceiver with the Icom Communications Interface-V (CI-V) commands. Set the transceiver's address, baud rate and transceive functions. See page 7-6 for setting the CI-V conditions using the Menu mode.

CI-V connection example

Connect the transceiver to a PC as shown below. To use the OPC-478UC CLONING CABLE and the OPC-592 CLONING CABLE ADAPTER, you must first install a USB driver. The driver and installation guide are supplied with the cloning cable. Read the guide carefully before installing the driver.

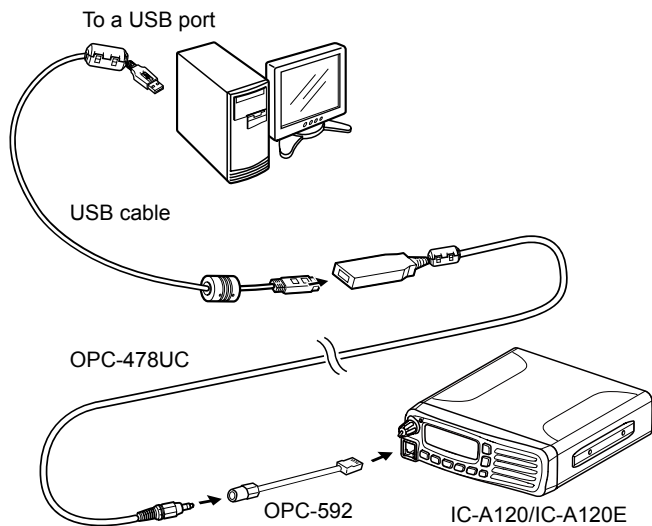

Data format

The CI-V system uses the following data formats. Data formats differ, depending on the command numbers. A data area or sub command is added to some commands.

Controller to IC-A120/IC-A120E

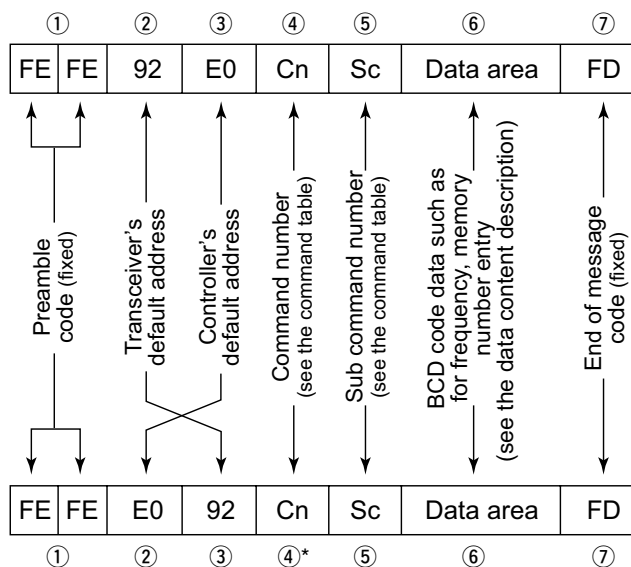

IC-A120/IC-A120E to controller

*The reply messages from the transceiver are the command "FB" (OK) or "FA" (NG).

Command table

Cmd.	Sub cmd.	Data	Description
00		See to the right	Send operating frequency for transceiver*1
01		See to the right below	Send operating mode for transceiver*1
03		See to the right	Read operating frequency
04		See to the right below	Read operating mode
05		See to the right	Send operating frequency*1
06		See to the right below	Send operating mode*1
14	01	0000 to 0255	Send/read audio output level
	03	p. 10-4	Send/read squelch level
15	01	00	Read squelch status (squelch close)
		01	Read squelch status (squelch open)
	05	00	Read squelch status (squelch close)
		01	Read squelch status (squelch open)
18	00		Turning OFF the transceiver power
	01		Turning ON the transceiver power*2
19	00		Read transceiver ID
1C	00	00	Send/read Transceiver's status (RX)
		01	Send/read Transceiver's status (TX)

*1 For only EXP, USA, and EUR versions.

*2 When sending the power ON command (1801), the command "FE" must be sent before the basic format.

• 19200bps: 27 • 9600bps: 14 • 4800bps: 8

Example: When operating with 4800 bps

F	E	F	E	9	2	E	O	1	8	0	1	F	D
		①		②		③		④		⑤		⑥	

*8

① Preamble code (fixed) ② Transceiver's default address

③ Controller's default address ④ Command number

⑤ Sub command number ⑥ End of message code (fixed)

◇ Operating frequency setting

Command: 00, 03, 05

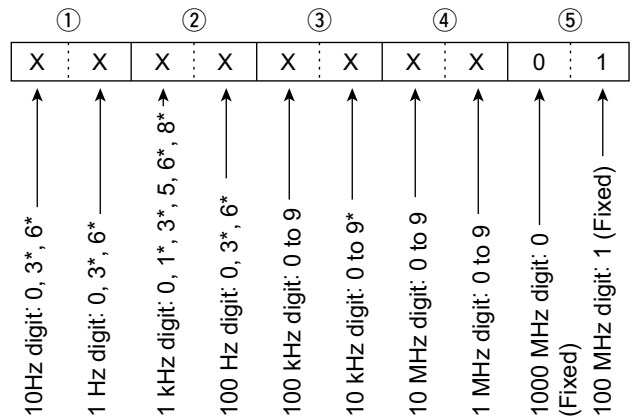

The frequency set by CI-V and the actual frequency differs, as described in the table below.

The frequency set by CI-V	Actual frequency
XXX. X00	XXX. X00 (AM)
	XXX. X00 (AM Narrow)
XXX. X08 333*	XXX. X10*
XXX. X16 666*	XXX. X15*
XXX. X25	XXX. X25 (AM)
	XXX. X30 (AM Narrow)
XXX. X33 333*	XXX. X35*
XXX. X41 666*	XXX. X40*
XXX. X50	XXX. X50 (AM)
	XXX. X55 (AM Narrow)
XXX. X58 333*	XXX. X60*
XXX. X66 666*	XXX. X65*
XXX. X75	XXX. X75 (AM)
	XXX. X80 (AM Narrow)
XXX. X83 333*	XXX. X85*
XXX. X91 666*	XXX. X90*

* For only 8.33 kHz channel spacing.

◇ Operating mode setting

Command: 01, 04, 06

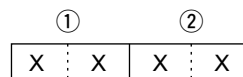

Operating mode	① Mode	② Filter setting
AM	02	01
AM-N	02	02

Command table (Continued)

◇ Squelch setting

Command: 1403

OFF	1	2	3	4
0000-0009	0010-0019	0020-0030	0031-0040	0041-0050
5	6	7	8	9
0051-0060	0061-0071	0072-0081	0082-0091	0092-0101
10	11	12	13	14
0102-0112	0113-0122	0123-0132	0133-0142	0143-0153
15	16	17	18	19
0154-0163	0164-0173	0174-0183	0184-0194	0195-0204
20	21	22	23	24
0205-0214	0215-0224	0225-0235	0236-0245	0246-0255

INDEX

	A			M	
Accessories, supplied		8-4		Main screen, indication type	7-7
AF output		6-3		Memory channel	4-2
	B			Deleting	4-2
Beep Level.....		7-7		Editing	4-2
Bluetooth				Entering frequency	4-3
Bluetooth function		7-8		Overwrite	7-4
Bluetooth headset use		7-8		Memory mode	2-2
Bluetooth operation		6-2		Menu mode, using	7-2
Device Search		7-4		MIC key customize	7-5
Disconnecting		6-4		Mounting the transceiver.....	8-3
Pairing		6-3			
Pairing list		7-4		N	
Pairing standby		7-4		Noise limiting.....	7-5
Unpairing		6-4			
	C			O	
Channel spacing		7-5		One-touch PTT.....	7-8
CI-V				On-hook scan	3-2
Address		7-6		Options	9-3
Baud rate		7-6			
Command table		10-3		P	
Data format		10-2		Password	2-2
Transceive.....		7-6		Power save	7-8
Connection				Priority channel.....	5-2, 7-5
Auto connect.....		7-8		Priority scan	3-2
Rear panel.....		8-2		PTT beep	7-8
	D				
Data device setting		7-9		R	
Device initialize		7-9		Receiving	2-2
Dualwatch		5-2			
	E			S	
Electromagnetic interference		6-2		Scan resume timer	7-6
	F			Scan types.....	3-2
Firmware version		7-9		Speaker selection.....	7-7
Front panel		1-2		Specifications	9-2
	G			Squelch	2-3
Group		7-3		Stop/TX channel	7-6
Group name		7-3, 7-4			
	H			T	
Headset setting.....		7-8		Time-out timer	7-5
	K			Transmitting	2-2
Key beep		7-7		Turning ON the transceiver.....	2-2
	L				
LCD backlight		7-7		U	
LCD contrast		7-7		UT-133A Information	7-9
Lock function.....		7-6			
Lockout channel		7-3, 7-4			

Count on us!

