



INSTRUCTION MANUAL

VHF TRANSCEIVER

IC-V80 IC-V80E

This device complies with Part 15 of the FCC Rules. Operation is subject to the following two conditions: (1) this device may not cause harmful interference, and (2) this device must accept any interference received, including interference that may cause undesired operation.

WARNING: MODIFICATION OF THIS DEVICE TO RECEIVE CELLULAR RADIOTELEPHONE SERVICE SIGNALS IS PROHIBITED UNDER FCC RULES AND FEDERAL LAW.

Icom Inc.



FOREWORD

Thank you for purchasing this fine Icom product. The IC-V80/V80E VHF TRANSCEIVER is designed and built with Icom's superior technology and craftsmanship. With proper care, this product should provide you with years of trouble-free operation.

We want to take a couple of moments of your time to thank you for making your IC-V80/V80E your radio of choice, and hope you agree with Icom's philosophy of "technology first." Many hours of research and development went into the design of your IC-V80/V80E.

FEATURES

- *Dust-protection/Splash-resistant construction (IP54*)*

*Only when the battery pack/case, antenna and jack cover are attached.

- *Built in VOX circuit enabling the VOX operation* (voice operated transmission)*

*To use the VOX operation, an optional headset and a plug adapter cable are additionally required.

EXPLICIT DEFINITIONS

WORD	DEFINITION
⚠ DANGER!	Personal death, serious injury or an explosion may occur.
⚠ WARNING!	Personal injury, fire hazard or electric shock may occur.
CAUTION	Equipment damage may occur.
NOTE	Recommended for optimum use. No risk of personal injury, fire or electric shock.

IMPORTANT

READ ALL INSTRUCTIONS carefully and completely before using the transceiver.

SAVE THIS INSTRUCTION MANUAL— This instruction manual contains important operating instructions for the IC-V80/V80E.

PRECAUTIONS

⚠ WARNING RF EXPOSURE! This device emits Radio Frequency (RF) energy. Caution should be observed when operating this device. If you have any questions regarding RF exposure and safety standards, please refer to the Federal Communications Commission Office of Engineering and Technology's report on Evaluating Compliance with FCC Guidelines for Human Radio Frequency Electromagnetic Fields (OET Bulletin 65)

⚠ WARNING! NEVER hold the transceiver so that the antenna is very close to, or touching exposed parts of the body, especially the face or eyes, while transmitting. The transceiver will perform best if the microphone is 5 to 10 cm (2 to 4 inches) away from the lips and the transceiver is vertical.

⚠ WARNING! NEVER operate the transceiver with a headset or other audio accessories at high volume levels. Hearing experts advise against continuous high volume operation. If you experience a ringing in your ears, reduce the volume level or discontinue use.

⚠ WARNING! NEVER operate the transceiver while driving a vehicle. Safe driving requires your full attention—anything less may result in an accident.

NEVER connect the transceiver to a power source using reverse polarity. This will ruin the transceiver.

DO NOT operate the transceiver near unshielded electrical blasting caps or in an explosive atmosphere.

DO NOT push [PTT] unless you actually intend to transmit.

BE CAREFUL! The transceiver will become hot when operating it continuously for long periods.

DO NOT use or place the transceiver in direct sunlight or in areas with temperatures below -20°C (-4°F) or above $+60^{\circ}\text{C}$ ($+140^{\circ}\text{F}$).

Place the unit in a secure place to avoid inadvertent use by children.

DO NOT use harsh solvents such as benzene or alcohol to clean the transceiver, because they can damage the transceiver's surfaces.

PRECAUTIONS

KEEP the transceiver away from heavy rain, and never immerse in the water. The transceiver meets IP54* requirements for dust-protection and splash resistance. However, once the transceiver has been dropped, dust-protection and splash resistance cannot be guaranteed because of possible damage to the transceiver's case or the waterproof seal.

* Only when the battery pack/case, antenna and jack cover are attached.

NEVER operate or touch the transceiver with wet hands. This may result in an electric shock or may damage the transceiver.

Even when the transceiver power is OFF, a slight current still flows in the circuits. Remove the battery pack or batteries from the transceiver when not using it for a long time. Otherwise, the installed battery pack or batteries will become exhausted, and will need to be recharged or replaced.

Approved Icom optional equipment is designed for optimal performance when used with an Icom transceiver. Icom is not responsible for the destruction or damage to an Icom transceiver in the event the Icom transceiver is used with equipment that is not manufactured or approved by Icom.

FCC INFORMATION

• FOR CLASS B UNINTENTIONAL RADIATORS:

This equipment has been tested and found to comply with the limits for a Class B digital device, pursuant to part 15 of the FCC Rules. These limits are designed to provide reasonable protection against harmful interference in a residential installation. This equipment generates, uses and can radiate radio frequency energy and, if not installed and used in accordance with the instructions, may cause harmful interference to radio communications. However, there is no guarantee that interference will not occur in a particular installation. If this equipment does cause harmful interference to radio or television reception, which can be determined by turning the equipment off and on, the user is encouraged to try to correct the interference by one or more of the following measures:

- Reorient or relocate the receiving antenna.
- Increase the separation between the equipment and receiver.
- Connect the equipment into an outlet on a circuit different from that to which the receiver is connected.
- Consult the dealer or an experienced radio/TV technician for help.

CAUTION: Changes or modifications to this device, not expressly approved by Icom Inc., could void your authority to operate this device under FCC regulations.

SUPPLIED ACCESSORIES

The following accessories are supplied with the transceiver.

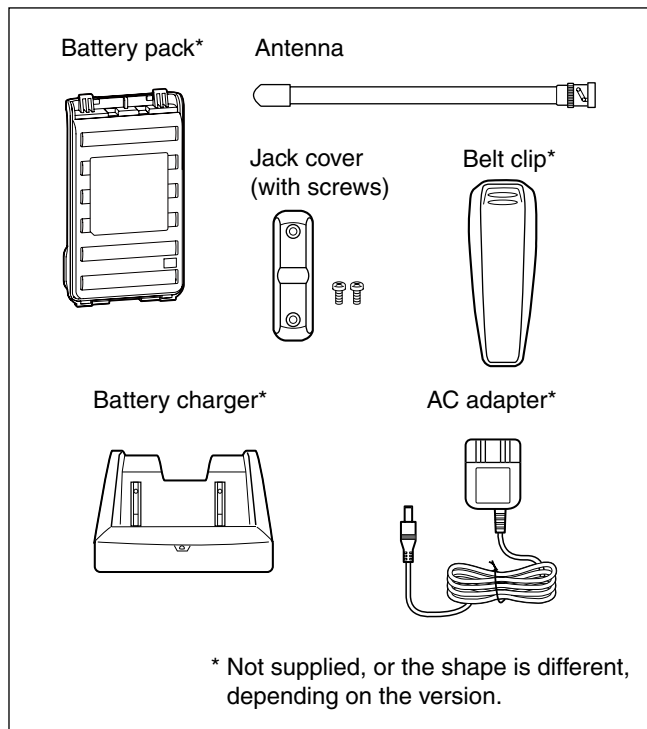

Icom, Icom Inc. and the Icom logo are registered trademarks of Icom Incorporated (Japan) in Japan, the United States, the United Kingdom, Germany, France, Spain, Russia and/or other countries.

Microsoft, Windows and Windows Vista are registered trademarks of Microsoft Corporation in the United States and/or other countries.

TABLE OF CONTENTS

FOREWORD	i
FEATURES	i
EXPLICIT DEFINITIONS	i
IMPORTANT	i
PRECAUTIONS	ii–iii
FCC INFORMATION	iii
SUPPLIED ACCESSORIES	iv
TABLE OF CONTENTS	v–vi

1 ACCESSORIES 1–2

■ Antenna	1
■ Belt clip	1
■ Battery pack/case	2
■ Jack cover	2

2 PANEL DESCRIPTION..... 3–7

■ Front, top and side panels	3
■ Function display	6

3 BATTERY CHARGING 8–13

■ Caution (for the BP-264 Ni-MH battery)	8
■ Caution (for the BP-265 Li-Ion battery)	9
■ Battery chargers	11
■ Battery case (BP-263)	13
■ Battery information	13

4 BASIC OPERATION..... 14–19

■ Power ON	14
■ Adjusting the volume level	14
■ Adjusting the squelch level	14

■ Monitor function	14
■ Mode selection	15
■ Operating mode selection	16
■ Setting a tuning step	16
■ Setting a frequency	16
■ Receiving	17
■ Transmitting	17
■ Key lock function	18
■ [VOL] function assignment	18
■ Weather channel operation (U.S.A. version only)	19

5 REPEATER AND DUPLEX OPERATION 20–23

■ Repeater operation	20
■ Duplex operation	21
■ Subaudible tones	22
■ Lockout function	23
■ Auto repeater function (U.S.A. version only)	23

6 MEMORY/CALL OPERATION 24–28

■ General description	24
■ Selecting a memory channel	24
■ Selecting the Call channel	24
■ Channel programming	25
■ Copying memory/Call contents	26
■ Clearing memory contents	27
■ Display type	27
■ Programming a channel name	28

TABLE OF CONTENTS

7 SCAN OPERATION.....	29–31	13 TROUBLE SHOOTING.....	50
■ Scan types.....	29	14 OPTIONS.....	51–53
■ Programmed scan	29	■ VOX function.....	52
■ Memory Scan	30	15 SPECIFICATIONS	54
■ Setting skip channels.....	30	16 CE	55–56
■ Scan resume setting.....	30		
■ Priority watch	31		
8 TONE SQUELCH AND POCKET BEEP	32–34		
■ Tone/DTCS squelch and pocket beep.....	32		
■ Tone scan.....	34		
9 DTMF MEMORY	35–37		
■ Programming a DTMF code sequence.....	35		
■ Transmitting a DTMF code sequence	36		
■ Confirming a DTMF memory	37		
■ Setting DTMF transfer speed.....	37		
10 SET MODES.....	38–47		
■ Set mode programming	38		
■ Set mode items.....	39		
■ Initial Set mode programming.....	43		
■ Initial Set mode items	44		
11 CLONING	48		
■ Cloning operation.....	48		
12 RESETTING	49		
■ Resetting.....	49		

1
2
3
4
5
6
7
8
9
10
11
12
13
14
15
16

■ Antenna

Insert the antenna into the antenna connector and twist the antenna to lock it in place.

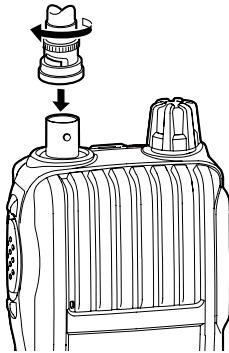

CAUTION:

- **NEVER HOLD** just the antenna when carrying the transceiver.
- Transmitting without an antenna will damage the transceiver.

■ Belt clip

To attach the belt clip:

- ➔ Slide the belt clip in the direction of the arrow until the belt clip locks in place, and makes a 'click' sound.

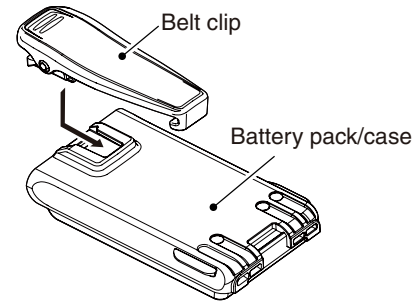

To detach the belt clip:

- ① Remove the battery pack/case from the transceiver, if it is attached. (p. 2).
- ② Lift the tab up (①), and slide the belt clip in the direction of the arrow (②).

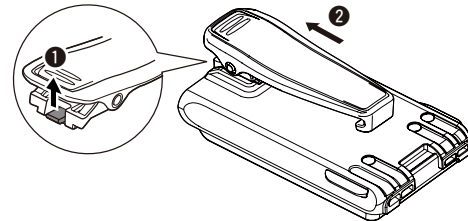

■ Battery pack/case

To attach the battery pack/case:

- ① Fit the battery pack/case in the direction of the arrow (①), then close.
- ② Hook the latch until it makes a 'click' sound (②).

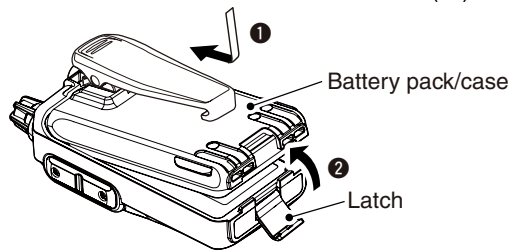

To remove the battery pack/case:

▨ **Be careful!** The latch is tightly locked, so use caution when releasing it. **DO NOT** use your finger nail. Use the edge of a coin or screwdriver tip to carefully release it.

- ➔ Unhook the latch (③), and lift up the battery pack/case in the direction of the arrow (④).

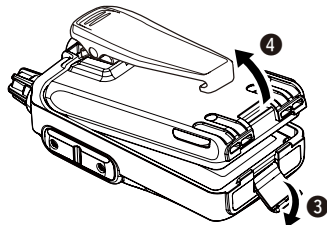

▨ **NEVER** remove or attach the battery pack/case when the transceiver is wet or soiled. This may result in water or dust getting into the transceiver/battery pack/case, and may result in them being damaged.

▨ **NOTE:** Keep the battery terminals clean. It's a good idea to clean the battery terminals once a week.

■ Jack cover

Attach the jack cover when optional equipment is not used.

To attach the jack cover

- ① Attach the jack cover to the [SP MIC] jack.
- ② Tighten the screws.

To detach the jack cover

- ③ Remove the screws with a phillips screwdriver.
- ④ Detach the jack cover to connect optional equipment.

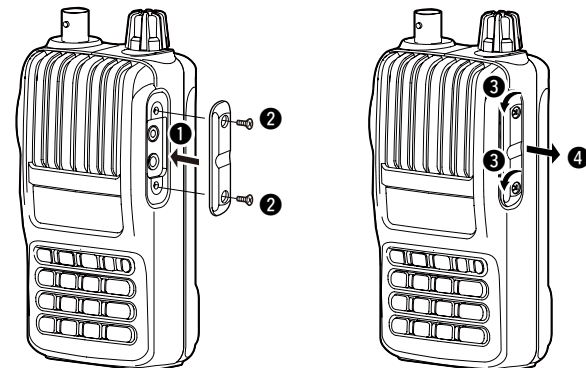

■ Front, top and side panels

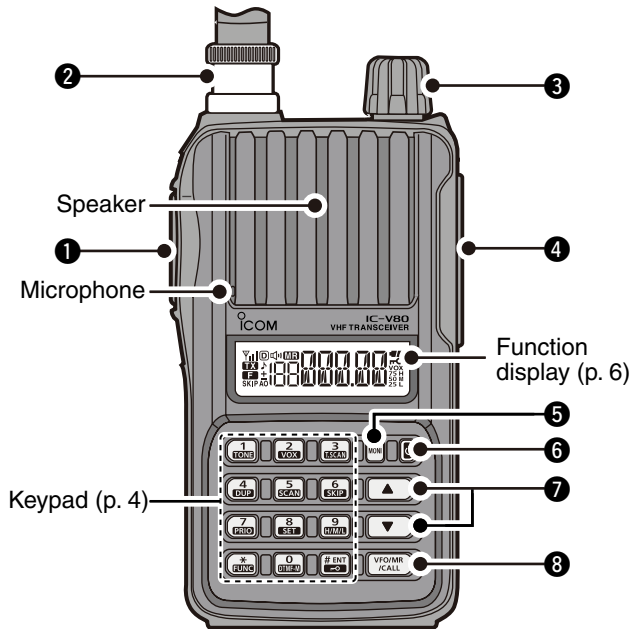

① PTT SWITCH [PTT]

➔ Push and hold to transmit, release to receive. (p. 17)

For IC-V80E only

➔ Push briefly, then push and hold to transmit a 1750 Hz tone burst signal. (p. 22)

② ANTENNA CONNECTOR

Connect the antenna here. (p. 1)

③ CONTROL DIAL [VOL]

➔ Adjust the volume level. (p. 14)

➔ During the Set mode, or Initial Set mode, rotate to select a desired option or value. (pp. 38, 43)

④ EXTERNAL SPEAKER/MICROPHONE JACKS [SP MIC]

Used to connect an optional speaker-microphone, plug adapter cable or cloning cable. The internal microphone and speaker will not function when an option is connected. See page 51 for a list of available options.

⚡ Be sure to turn power OFF before connecting/disconnecting optional equipment to/from the [SP/MIC] jack.

⑤ MONITOR KEY [MONI]

➔ Push and hold to open the squelch temporarily to monitor the operating frequency. (p. 14)

➔ While pushing and holding this key, push [▲] or [▼] to adjust the squelch level. (p. 14)

➔ Enters or sends the DTMF code 'A.' (pp. 35, 36)

6 POWER KEY [⏻]

Push and hold for 1 sec. to turn the transceiver power ON or OFF. (p. 14)

7 UP/DOWN KEYS [▲]/[▼]

- ➔ Push to change the operating frequency. (p. 16)
- ➔ During memory mode operation, push to select a memory channel. (p. 24)
- ➔ While scanning, push to change the scanning direction. (pp. 29, 30, 31, 34)
- ➔ While pushing and holding [MONI], push to set the squelch level. (p. 14)
- ➔ During the Set mode, or Initial Set mode, push to select a desired setting item. (pp. 38, 43)
- ➔ [▲] enters or sends the DTMF code 'B.' (pp. 35, 36)
- ➔ [▼] enters or sends the DTMF code 'C.' (pp. 35, 36)

8 VFO/MEMORY/CALL KEY [VFO/MR/CALL]

- ➔ Push to select the VFO mode, memory mode, a Call channel and a weather channel*, in sequence. (p. 15)
*Only the U.S.A. version transceivers.
- ➔ After pushing [FUNC](*), push to enter the memory programming mode.
- ➔ After pushing [FUNC](*), push and hold for 1 sec. to transfer a channel contents to a memory channel, or to the VFO mode. (p. 26)
- ➔ Enters or sends the DTMF code 'D.' (pp. 35, 36)

▨ The functions of [VOL] and [▲]/[▼] can be exchanged. See page 18 for details.

◇ KEYPAD

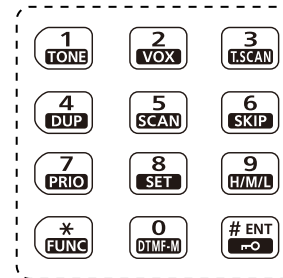

- ➔ Push to input numbers for frequency input and memory channel selection.
- ➔ Push to enter or send the DTMF code. (pp. 35, 36)
- ➔ To activate the second function of a key, first push [FUNC](*), and then push the key.



[1] • [TONE](1)

- ➔ Numeric input and DTMF code: '1'
- ➔ After pushing [FUNC](*), selects the Tone function. (p. 33)



[2] • [VOX](2)

- ➔ Numeric input and DTMF code: '2'
- ➔ After pushing [FUNC](*), turns the VOX function ON or OFF*. (p. 52)

* Only when an optional headset and plug adapter are connected.

2 PANEL DESCRIPTION

3
T.SCAN

[3] • [T.SCAN](3)

- ➔ Numeric input and DTMF code: '3'
- ➔ After pushing **[FUNC](*)**, starts a tone scan. (p. 34)

4
DUP

[4] • [DUP](4)

- ➔ Numeric input and DTMF code: '4'
- ➔ After pushing **[FUNC](*)**, selects minus duplex, plus duplex, or simplex operation. (p. 21)

5
SCAN

[5] • [SCAN](5)

- ➔ Numeric input and DTMF code: '5'
- ➔ After pushing **[FUNC](*)**, starts a scan. (pp. 29, 30)

6
SKIP

[6] • [SKIP](6)

- ➔ Numeric input and DTMF code: '6'
- ➔ After pushing **[FUNC](*)**, sets or cancels the skip setting. (p. 30)

7
PRIO

[7] • [PRIO](7)

- ➔ Numeric input and DTMF code: '7'
- ➔ After pushing **[FUNC](*)**, starts a priority watch. (p. 31)

8
SET

[8] • [SET](8)

- ➔ Numeric input and DTMF code: '8'
- ➔ After pushing **[FUNC](*)**, enters the Set mode. (p. 38)

9
H/M/L

[9] • [H/M/L](9)

- ➔ Numeric input and DTMF code: '9'
- ➔ After pushing **[FUNC](*)**, selects the output power between high, middle and low. (p. 17)

0
DTMF-M

[0] • [DTMF-M](0)

- ➔ Numeric input and DTMF code: '0'
- ➔ After pushing **[FUNC](*)**, enters the DTMF memory mode. (p. 35)

*
FUNC

[*] • [FUNC](*)

- ➔ DTMF code: '* (indication: E)'
- ➔ Push to access the second function of other keys.

ENT
r-O

[# ENT] • [r-O](# ENT)

- ➔ DTMF code: '# (indication: F)'
- ➔ After entering a frequency, stores the frequency. (p. 16)
- ➔ Push to exit the Set mode or Initial Set mode. (pp. 38, 43)
- ➔ After pushing **[FUNC](*)**, push and hold for 1 sec. to turn the key lock function ON or OFF (p. 18)

■ Function display

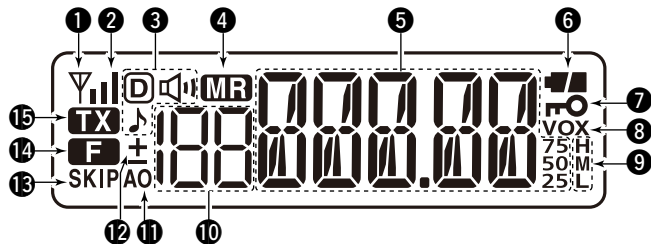

1 BUSY INDICATOR

- Appears when a signal is being received, or the squelch is open.
- Blinks while the monitor function is ON. (p. 14)

2 SIGNAL INDICATOR

- Shows the strength of the received signal. (p. 17)



- While transmitting, shows the output power level. (p. 17)



3 TONE INDICATOR

- “T” appears while the repeater tone encoder is ON. (p. 20)
- “S” appears while the tone squelch function is ON. (p. 33)
- “D” appears while the DTCS squelch function is ON. (p. 33)
- “P” appears with the “S” or “D” indicator while the pocket beep function (with CTCSS or DTCS) is ON. (p. 33)

4 MEMORY INDICATOR

- Appears when the memory mode is selected. (pp. 15, 24)

5 FREQUENCY READOUT

- Displays the operating frequency, memory channel, Set modes contents and a variety of other information.
 - The decimal point blinks during scan.
- During memory mode operation, the programmed memory name is displayed.

6 BATTERY INDICATOR (p. 13)

- “■/■” (battery indicators) appear when the battery pack/case is attached.
- “■” appears when the battery pack must be changed, or batteries must be replaced.

2 PANEL DESCRIPTION

7 KEY LOCK INDICATOR

Appears when the key lock function is ON. (p. 18)

8 VOX INDICATOR

Appears when the VOX function is ON. (p. 52)

9 POWER INDICATOR (p. 17)

- “H” appears when high power is selected.
- “M” appears when middle power is selected.
- “L” appears when low power is selected.

10 MEMORY CHANNEL NUMBER INDICATOR

- Displays the selected memory channel number. (p. 24)
- “C” appears when the Call channel is selected. (p. 24)

11 AUTO POWER OFF INDICATOR

Displays when the Auto Power OFF function is ON. (p. 44)

12 DUPLEX INDICATOR (p. 21)

- “+” appears when plus duplex is selected.
- “-” appears when minus duplex is selected.

13 SKIP INDICATOR

Appears when the selected memory channel is set as a skip channel. (p. 30)

14 FUNCTION INDICATOR

Appears when the second function can be accessed.

15 TRANSMIT INDICATOR

Appears while transmitting. (p. 17)

■ **Caution** (for the BP-264 Ni-MH battery)

⚠ **DANGER! NEVER** short terminals (or charging terminals) of the battery pack. Also, current may flow into nearby metal objects such as a necklace, so be careful when placing battery packs (or the transceiver) in handbags, etc.

Simply carrying with or placing near metal objects such as a necklace, etc. may cause shorting. This may damage not only the battery pack, but also the transceiver.

⚠ **DANGER! NEVER** incinerate used battery packs. Internal battery gas may cause an explosion.

⚠ **DANGER! NEVER** immerse the battery pack in water. If the battery pack becomes wet, be sure to wipe it dry **BEFORE** attaching it to the transceiver.

CAUTION: Always use the battery within the specified temperature range, -5°C to $+60^{\circ}\text{C}$ ($+23^{\circ}\text{F}$ to $+140^{\circ}\text{F}$). Using the battery out of its specified temperature range will reduce the battery's performance and battery life.

CAUTION: Shorter battery life could occur if the battery is left completely discharged, or in an excessive temperature environment (above $+55^{\circ}\text{C}$; $+131^{\circ}\text{F}$) for an extended period of time. If the battery must be left unused for a long time, it must be detached from the radio after charging. Keep it safely in a cool dry place at the following temperature range:

- -20°C to $+45^{\circ}\text{C}$ (-4°F to $+113^{\circ}\text{F}$) (up to a month)
- -20°C to $+35^{\circ}\text{C}$ (-4°F to $+95^{\circ}\text{F}$) (up to six months)
- -20°C to $+25^{\circ}\text{C}$ (-4°F to $+77^{\circ}\text{F}$) (up to a year*)

* We recommend charging the battery pack every 6 months.

Clean the battery terminals to avoid rust or misscontact.

Keep battery terminals clean. It's a good idea to clean battery terminals once a week.

If your Ni-MH battery pack seems to have no capacity, even after being charged, completely discharge it by leaving the power ON overnight. Then, fully charge the battery pack again. If the battery pack still does not retain a charge (or only very little charge), a new battery pack must be purchased. (p. 51) Prior to using the transceiver for the first time, the battery pack must be fully charged for optimum life and operation.

- Recommended temperature range for charging:
 - between $+10^{\circ}\text{C}$ and $+40^{\circ}\text{C}$ (rapid charge: with BC-191) or between 0°C and $+45^{\circ}\text{C}$ (regular charge: with BC-192)
- Use the supplied charger or optional charger (BC-191 for rapid charging, BC-192 for regular charging) only. **NEVER** use other manufacturers' chargers.

The battery pack contains a rechargeable battery.

Charge the battery pack before first operating the transceiver, or when the battery pack becomes exhausted.

If you want to prolong the battery life, the following points should be observed:

- Avoid over charging. The charging time period should be less than 48 hours.
- Use the battery pack until it becomes almost completely exhausted, under normal conditions. We recommend battery charging after transmitting becomes impossible.

3 BATTERY CHARGING

■ **Caution** (for the BP-265 Li-Ion battery)

Misuse of Li-Ion batteries may result in the following hazards: smoke, fire, or the battery may rupture. Misuse can also cause damage to the battery or degradation of battery performance.

⚠ **DANGER!** Use and charge only specified Icom battery packs with Icom radios or Icom chargers. Only Icom battery packs are tested and approved for use with Icom radios or charged with Icom chargers. Using third-party or counterfeit battery packs or chargers may cause smoke, fire, or cause the battery to burst.

◇ **Battery caution**

⚠ **DANGER! DO NOT** hammer or otherwise impact the battery. Do not use the battery if it has been severely impacted or dropped, or if the battery has been subjected to heavy pressure. Battery damage may not be visible on the outside of the case. Even if the surface of the battery does not show cracks or any other damage, the cells inside the battery may rupture or catch fire.

⚠ **DANGER! NEVER** use or leave battery pack in areas with temperatures above +60°C (+140°F). High temperature buildup in the battery, such as could occur near fires or stoves, inside a sun heated car, or in direct sunlight may cause the battery to rupture or catch fire. Excessive temperatures may also degrade battery performance or shorten battery life.

⚠ **DANGER! DO NOT** expose the battery to rain, snow, seawater, or any other liquids. Do not charge or use a wet battery. If the battery gets wet, be sure to wipe it dry before using.

⚠ **DANGER! NEVER** incinerate a used battery pack since internal battery gas may cause it to rupture, or may cause an explosion.

⚠ **DANGER! NEVER** solder the battery terminals, or **NEVER** modify the battery pack. This may cause heat generation, and the battery may burst, emit smoke or catch fire.

⚠ **DANGER!** Use the battery only with the transceiver for which it is specified. Never use a battery with any other equipment, or for any purpose that is not specified in this instruction manual.

⚠ **DANGER!** If fluid from inside the battery gets in your eyes, blindness can result. Rinse your eyes with clean water, without rubbing them, and see a doctor immediately.

⚠ **WARNING!** Immediately stop using the battery if it emits an abnormal odor, heats up, or is discolored or deformed. If any of these conditions occur, contact your Icom dealer or distributor.

⚠ **WARNING!** Immediately wash, using clean water, any part of the body that comes into contact with fluid from inside the battery.

⚠ **WARNING! NEVER** put the battery in a microwave oven, high-pressure container, or in an induction heating cooker. This could cause a fire, overheating, or cause the battery to rupture.

CAUTION: Always use the battery within the specified temperature range, -20°C to $+60^{\circ}\text{C}$ (-4°F to $+140^{\circ}\text{F}$). Using the battery out of its specified temperature range will reduce the battery's performance and battery life.

CAUTION: Shorter battery life could occur if the battery is left fully charged, completely discharged, or in an excessive temperature environment (above $+50^{\circ}\text{C}$; $+122^{\circ}\text{F}$) for an extended period of time. If the battery must be left unused for a long time, it must be detached from the radio after discharging. You may use the battery until the battery indicator shows half-capacity, and then keep it safely in a cool dry place at the following temperature range:

- -20°C to $+50^{\circ}\text{C}$ (-4°F to $+122^{\circ}\text{F}$) (up to a month)
- -20°C to $+35^{\circ}\text{C}$ (-4°F to $+95^{\circ}\text{F}$) (up to three months)
- -20°C to $+20^{\circ}\text{C}$ (-4°F to $+68^{\circ}\text{F}$) (up to a year)

◇ Charging caution

⚠ **DANGER! NEVER** charge the battery pack in areas with extremely high temperatures, such as near fires or stoves, inside a sun-heated vehicle, or in direct sunlight. In such environments, the safety/protection circuit in the battery will activate, causing the battery to stop charging.

⚠ **WARNING! DO NOT** charge or leave the battery in the battery charger beyond the specified time for charging. If the battery is not completely charged by the specified time, stop charging and remove the battery from the battery charger. Continuing to charge the battery beyond the specified time limit may cause a fire, overheating, or the battery may rupture.

⚠ **WARNING! NEVER** insert the transceiver (battery attached to the transceiver) into the charger if it is wet or soiled. This could corrode the battery charger terminals or damage the charger. The charger is not waterproof.

CAUTION: DO NOT charge the battery outside of the specified temperature range: BC-193 ($+10^{\circ}\text{C}$ to $+40^{\circ}\text{C}$; $+50^{\circ}\text{F}$ to $+104^{\circ}\text{F}$). Icom recommends charging the battery at $+20^{\circ}\text{C}$ ($+68^{\circ}\text{F}$). The battery may heat up or rupture if charged out of the specified temperature range. Additionally, battery performance or battery life may be reduced.

- ▨ The supplied battery pack, charger, and AC adapter differ, or no supplied depending on the version.
- ▨ Prior to using the transceiver for the first time, the battery pack must be fully charged for optimum life and operation.

3 BATTERY CHARGING

■ Battery chargers

◇ Using the BC-191 to rapid charge the BP-264

The BC-191 provides rapid charging of only the BP-264 Ni-MH battery pack. Never use it to charge any other battery pack. Charging time: Approx. 2 hours

The following item is additionally required:

- An AC adapter (not supplied with some versions) or the OPC-515L or CP-23L DC power cable.

AC adapter
(A different type, or no AC adapter is supplied, depending on the version.)

Battery pack

Transceiver

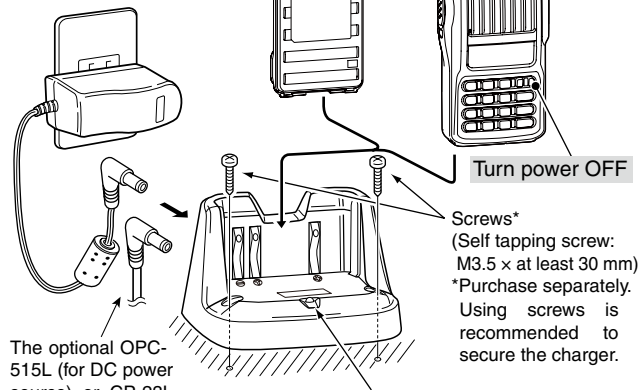

The optional OPC-515L (for DC power source) or CP-23L (for 12 V cigarette lighter socket) can be used instead of the AC adapter.

Charge indicator

- Lights orange : While charging
- Lights green : Charging is completed.

◇ Using the BC-192 to regular charge the BP-264

The BC-192 provides regular charging of only the BP-264 Ni-MH battery pack. Never use it to charge any other battery pack.

Charging time (with the 147S): Approx. 16 hours

The following item is additionally required:

- An AC adapter (not supplied with some versions) or the OPC-515L DC power cable.

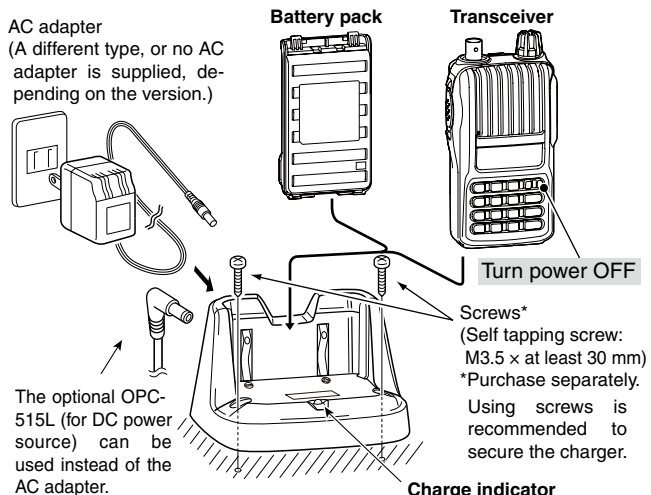

Charging time period differs depending on the input voltage.

12 V	: Approx. 36 hours
13.8 V	: Approx. 21 hours
16 V	: Approx. 16 hours

Charge indicator

- Lights green while charging.

NOTE:

The charge indicator will not go out even after a battery pack is fully charged.

◇ **Using the BC-193 to rapid charge the BP-265**

The BC-193 provides rapid charging of only the BP-265 Li-Ion battery pack. Never use it to charge any other battery pack.

Charging time: Approx. 2.5 hours

The following item is additionally required:

- An AC adapter (not supplied with some versions) or the OPC-515L or CP-23L DC power cable.

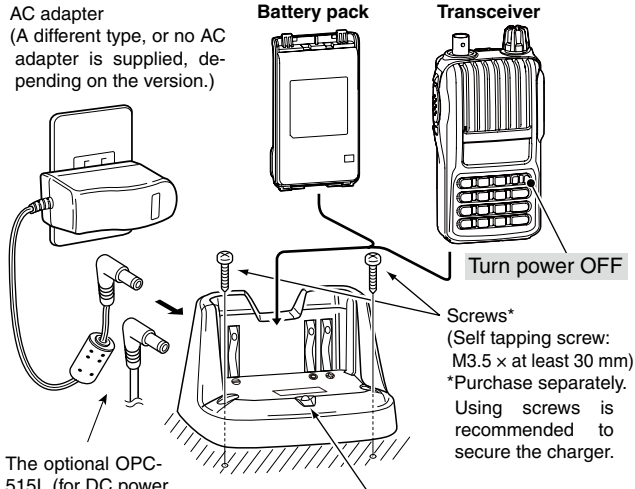

The optional OPC-515L (for DC power source) or CP-23L (for 12 V cigarette lighter socket) can be used instead of the AC adapter.

Charge indicator

- Lights orange : While charging
- Lights green : Charging is completed.

/// **IMPORTANT: Battery charging caution**

Ensure the tabs on the battery pack are correctly aligned with the guide rails inside the charger.

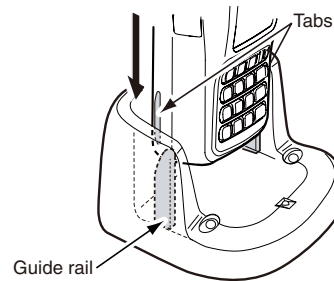

/// **CAUTION: When using the OPC-515L DC power cable**

NEVER connect the OPC-515L to a power source using reverse polarity. This will ruin the battery charger.

/// White line: ⊕ Black line: ⊖

3 BATTERY CHARGING

■ Battery case (BP-263)

When using the battery case (BP-263), install 6 × AA (LR6) size alkaline batteries, as described below.

- ① Remove the battery case if it is attached. (p. 2)
- ② Install 6 × AA (LR6) size alkaline batteries.
 - Install only alkaline batteries.
 - Be sure to observe the correct polarity.
- ③ Attach the battery case. (p. 2)

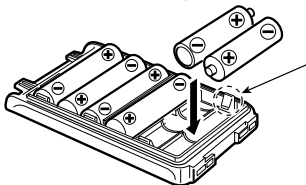

Be careful! The negative terminals of the battery case protrude from the body, so pay attention not to injure your fingers when inserting the batteries.

CAUTION:

- When installing batteries, make sure they are all the same brand, type and capacity. Also, do not mix new and old batteries together.
- Keep battery terminals clean. It's a good idea to clean battery terminals once a week.
- Never incinerate used battery cells since the internal battery gas may cause them to rupture.
- Never expose a detached battery case to water. If the battery case gets wet, be sure to wipe it dry before using it.
- Never use batteries whose insulated covering is damaged.

NOTE: When the battery case is attached, the battery protection function must be turned OFF in the Initial Set mode (p. 47).

■ Battery information

◇ Battery life

Battery pack/case	Voltage	Capacity	Battery life*1
BP-263	Battery case for AA (LR6) × 6 alkaline		—*2
BP-264	7.2 V	1400 mAh	13 hrs.
BP-265	7.4 V	1900 mAh (min.) 2000 mAh (typ.)	19 hrs.

*1 When the power save function is set to “P-S.At,” and the operating time is calculated under the following conditions;



TX : RX : standby = 5 : 5 : 90

*2 The average operating life depends on the alkaline cells used.

Even when the transceiver power is OFF, a small current still flows in the transceiver. Remove the battery pack/case when it won't be used for a long time. Otherwise, the battery pack or the batteries in the case will become exhausted.

◇ Battery indication

The battery indicator, “,” appears when a battery pack/case is attached to the transceiver.

Indicator	Battery condition
	The battery has ample capacity.
	The battery is nearing exhaustion. Charging the battery pack, or replacing the batteries in the case is necessary.

■ Power ON

- ➔ Push and hold [POWER] for 1 sec. to turn the power ON.
 - Push and hold [POWER] for 1 sec. to turn the power OFF.

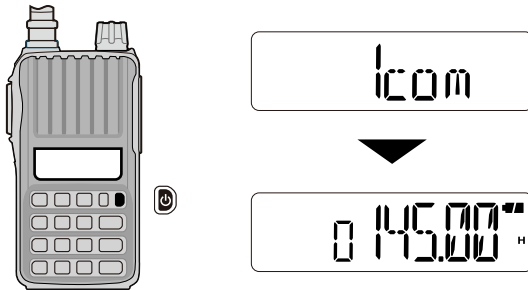

■ Adjusting the volume level

- ➔ Rotate [VOL] to adjust the volume level.
 - If the squelch is closed, push and hold [MONI] while adjusting the volume level.
 - The display shows the volume level while adjusting.



■ Adjusting the squelch level

- ➔ While pushing and holding [MONI], push [▲] or [▼] several times to adjust the squelch level.
 - “SqL 1” is loose squelch (for weak signals) and “SqL10” is tight squelch (for strong signals). “SqL 0” is open squelch.

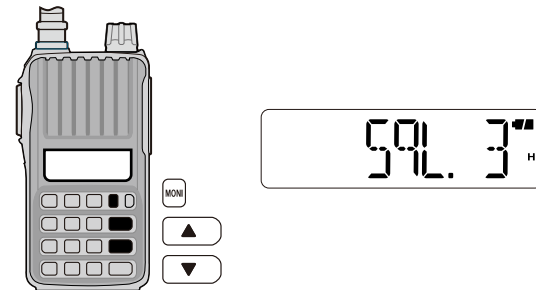

■ Monitor function

This function is used to listen to weak signals or to open the squelch manually. You can use it without disturbing the squelch setting, even when mute functions such as the tone squelch are in use.

- ➔ Push and hold [MONI] to monitor the operating frequency.
 - “F” blinks while the monitor function is ON.

4 BASIC OPERATION

■ Mode selection

➔ Push [VFO/MR/CALL] several times to select the VFO mode, memory mode, Call channel mode and weather channel mode*, in sequence.

*For only the U.S.A. version transceivers.

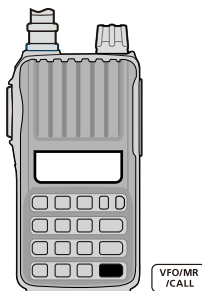

◇ VFO mode

The VFO mode is used to set the operating frequency.

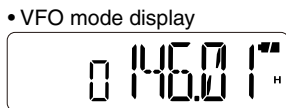

What is VFO?

VFO is an abbreviation of Variable Frequency Oscillator. Frequencies for both transmitting and receiving are generated and controlled by the VFO.

◇ Memory mode

The memory mode is used for operating on memory channels, which store programmed frequencies.

• "MR" appears when the memory mode is selected.

• Memory mode display

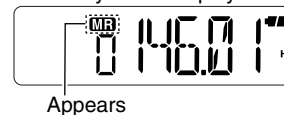

◇ Call channel mode

The Call channel is used for quick recall of the most often-used frequency.

• "C" appears instead of the memory channel number when the Call channel mode is selected.

• Call channel mode display



◇ Weather channel mode*

There are 10 weather channels for monitoring weather broadcasts from NOAA (National Oceanic and Atmospheric Administration).

*Only for the U.S.A. version transceivers.

• Weather channel mode display

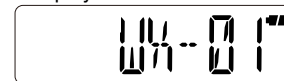

■ Operating mode selection

Operating modes are determined by the modulation of the radio signals. The transceiver has the FM and FM-N modes. The mode selection is independently stored for each memory channel.

- ① Push **[FUNC](*)** then **[SET](8)** to enter the Set mode.
- ② Push **[▲]** or **[▼]** to select the operating mode item. (W/n)
- ③ Rotate **[VOL]** to set the operating mode to FM or FM-N.

FM mode



FM-N mode



- ④ Push **[# ENT]** to exit the Set mode.

■ Setting a tuning step

The transceiver has 8 tuning step options;

- 5 kHz
- 10 kHz
- 12.5 kHz
- 15 kHz
- 20 kHz
- 25 kHz
- 30 kHz
- 50 kHz

The tuning step can be selected in the Set mode.

- ① Push **[FUNC](*)**, and then **[SET](8)** to enter the Set mode.
- ② Push **[▲]** or **[▼]** to select the tuning step item. (tS)
- ③ Rotate **[VOL]** to select the desired tuning step.

20 kHz tuning step



- ④ Push **[# ENT]** to exit the Set mode.

■ Setting a frequency

◇ Using **[▲]** or **[▼]**

- ① Push **[VFO/MR/CALL]** several times to select the VFO mode.
- ② Push **[▲]** or **[▼]** to select the desired frequency.
 - The frequency changes according to the preset tuning steps. See the previous topic to set the tuning step.

◇ Using the keypad

- ① Push **[VFO/MR/CALL]** several times to select the VFO mode.
- ② To enter the desired frequency, enter 6 digits, starting from 100 MHz digit.
 - Entering two or three* to five digits, and then pushing **[# ENT]**, also sets the frequency. (*Depending on the version)
 - If a frequency outside the frequency range is entered, the previously displayed frequency is automatically recalled.

• Example 1— entering 145.525 MHz



• Example 2— entering 144.800 MHz



4 BASIC OPERATION

■ Receiving

Make sure the BP-264 or BP-265 battery pack is fully charged, or the BP-263 battery case has brand new alkaline batteries (pp. 11–13).

- ① Push and hold **[PWR]** for 1 sec. to turn power ON.
- ② Rotate **[VOL]** to set the desired volume level. (p. 14)
 - The volume level is displayed on the LCD while adjusting.
- ③ Set the receive frequency. (p. 16)
- ④ Set the squelch level. (p. 14)
 - While pushing and holding **[MONI]**, push **[▲]** or **[▼]**.
 - The squelch level is displayed on the LCD while setting.
 - “SqL 1” is loose squelch (for weak signals) and “SqL10” is tight squelch (for strong signals). “SqL 0” is open squelch.
 - Push and hold **[MONI]** to open the squelch manually.
- ⑤ When a signal is received:
 - The squelch is opened and the audio is heard.
 - The signal indicator shows the relative signal strength level.

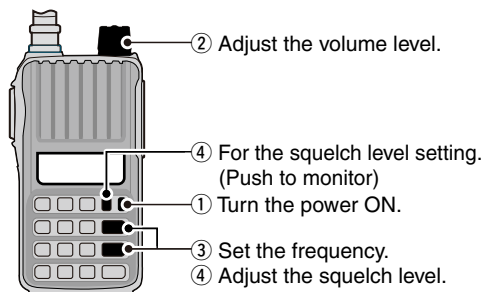

■ Transmitting

CAUTION: Transmitting without an antenna will damage the transceiver.

NOTE: To prevent interference, push and hold **[MONI]** to listen on the frequency before transmitting.

- ① Set the operating frequency. (p. 16)
- ② Push **[FUNC](*)**, and then push **[H/M/L](9)** to select the output power between High (5.5 W), Mid (2.5 W) and Low (0.5 W).
 - “H,” “M,” or “L” appears according to the selected output power.
- ③ Push and hold **[PTT]** to transmit.
 - “**TX**” appears while transmitting.
 - The signal indicator shows the output power level.
- ④ Speak into the microphone using your normal voice level.
 - DO NOT hold the transceiver too close to your mouth or speak too loudly. This may distort your speech.
- ⑤ Release **[PTT]** to return to receive.

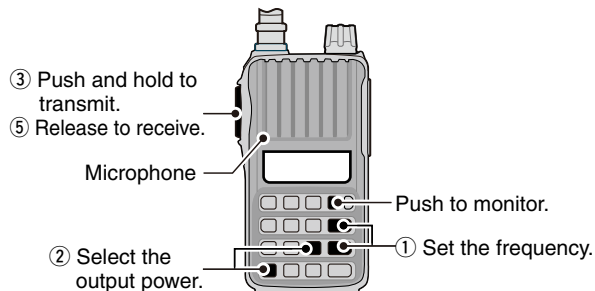

⚠ WARNING! When using the BP-263 battery case, frequent or continuous transmissions can cause the batteries to overheat, and may cause a burn. To prevent this, the default time-out timer is set to 5 minutes (p. 44). Be careful when the time-out timer function is turned OFF or set to a long time period, and transmission is made for long periods.

- We recommend using the middle or low power setting.

■ Key lock function

To prevent accidental frequency changes, or unnecessary function access, use the key lock function.

- ➔ Push **[FUNC](*)**, and then push and hold **[r-O](# ENT)** for 1 sec. to turn the key lock function ON or OFF.
 - “**r-O**” appears while the key lock function is activated.
 - **[P], [VOL], [MONI], [PTT]** and **[FUNC](*) + [r-O](# ENT)** are still operable while the key lock function is ON.

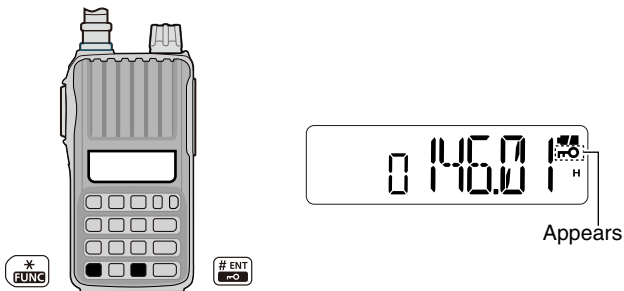

■ [VOL] function assignment

[VOL] can be used as a tuning control instead of **[▲]** and **[▼]**, to suit your preference. However, when **[VOL]** functions as a tuning control, **[▲]** and **[▼]** function as volume controls.

- ① While pushing and holding **[▲]** and **[▼]**, turn the power ON to enter the Initial Set mode.
- ② Push **[▲]** or **[▼]** to select the dial assignment item. (tOP)
- ③ Rotate **[VOL]** to select an option.
- ④ Push **[# ENT]** to exit the Initial Set mode.

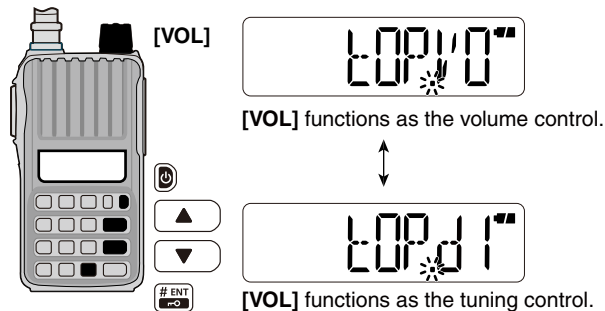

▨ **[VOL]** and **[▲]/[▼]** function as described below, depending on the option.

Option	[VOL]	[▲]/[▼]
tOP.VO	Volume control	Tuning controls
tOP.di	Tuning control	Volume controls

4 BASIC OPERATION

■ Weather channel operation

There are 10 weather channels for monitoring weather broadcasts from NOAA (National Oceanic and Atmospheric Administration).



◇ Weather channel selection

- ① Push **[VFO/MR/CALL]** several times to select the weather channel mode.

- Weather channel mode display



- ② Push **[▲]** or **[▼]** to select a weather channel.
- ③ Push **[VFO/MR/CALL]** to return to the previous frequency or memory channel.

◇ Weather alert function

NOAA broadcast stations transmit weather alert tones before important weather announcements. When the weather alert function is ON, the selected weather channel is monitored every 5 sec. for announcements. When the alert signal is detected, the "ALT" and the WX channel number are alternately displayed, and a beep sounds until the transceiver is operated. The previously selected (used) weather channel is checked periodically during standby, or while scanning.

U.S.A. version only

- ① Select a weather channel.
- ② Turn the weather alert function ON in the Set mode.
 - ➔ Push **[FUNC](*)**, and then **[SET](8)** to enter the Set mode.
 - ➔ Push **[▲]** or **[▼]** to select the weather alert item. (ALT)
 - ➔ Rotate **[VOL]** to select "ON."
 - ➔ Push **[# ENT]** to exit the Set mode.
- ③ Set the desired stand-by mode.
 - Select the VFO, memory or Call channel mode.
 - Scan or priority watch operation can also be selected.
- ④ When an alert is detected, a beep sounds, and "ALT" and the weather channel number will be alternately displayed.

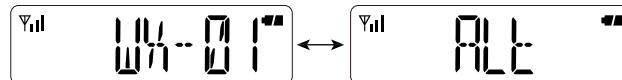

- ⑤ Turn the weather alert function OFF in the Set mode.

/// **NOTE:** While receiving a signal on a frequency other than the Weather alert frequency, the receiving signal will be interrupted momentarily approximately every 5 sec. when the weather alert function is ON. These interruptions cease when the weather alert function is turned OFF.

/// Push **[FUNC](*)**, and then **[SCAN](5)** to start a weather channel scan. Push any key except **[▲]/[▼]**, **[FUNC](*)** and **[MONI]** to stop the scan.

■ Repeater operation

When using a repeater, the transmit frequency is shifted from the receive frequency by the frequency offset (p. 21). This is called duplex operation. It is convenient to program repeater information into memory channels (p. 25).

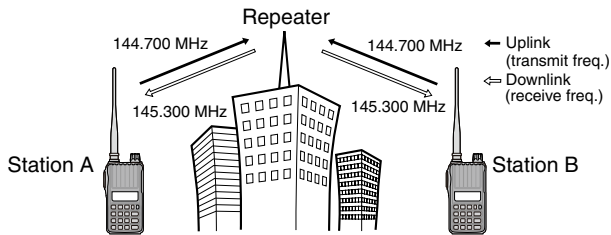

- ① Set the receive frequency (the repeater output frequency).
- ② Push **[FUNC](*)**, and then **[DUP](4)** several times to set the shift direction of the transmit frequency. (“-” or “+”; See page 21 for details.)
 - When the auto repeater function is in use (U.S.A. version only), this selection and step ③ are not necessary. (p. 23).
- ③ If desired, push **[FUNC](*)** and then **[TONE](1)** several times to activate the subaudible tone encoder.
 - “♪” appears.
 - Select the desired subaudible tone frequency. (p. 22)

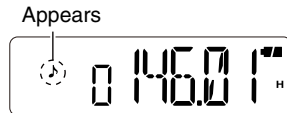

- ④ Push and hold **[PTT]** to transmit.
 - The displayed frequency automatically changes to the transmit frequency (repeater input frequency).
 - If “OFF” appears, check the frequency offset and shift direction (p. 21).
- ⑤ Release **[PTT]** to receive.

While receiving

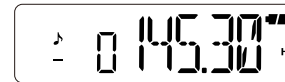

While transmitting

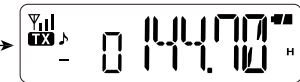

- ⑥ Push and hold **[MONI]** to check whether the other station's transmit signal can be directly received or not.
 - When the other station's signal can be directly received, move to a non-repeater frequency to use simplex. (duplex OFF)

For the U.S.A. version:

Auto repeater function uses standard values of the repeater tone frequency and frequency offset.

5 REPEATER OPERATION

■ Duplex operation

◇ Setting the frequency offset

- ① Push **[FUNC](*)**, and then **[SET](8)** to enter the Set mode.
- ② Push **[▲]** or **[▼]** to select the offset item.
 - “±” blinks, and the current frequency offset appears.
- ③ Rotate **[VOL]** to select the frequency offset.
 - The offset is selected in the same step as the frequency tuning step.
 - The unit of the frequency offset is “MHz.”
- ④ Push **[# ENT]** to exit the Set mode.

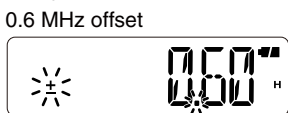

◇ Setting the duplex direction

- ➔ Push **[FUNC](*)**, and then **[DUP](4)** to select “-” (negative offset) or “+” (positive offset).
 - “-” or “+” indicates the transmit frequency is shifter up (+) or down (-) from the receive frequency.
 - Blinking “-” or “+” indicates the reverse duplex function is ON, as described to the right.

• Example— When the offset frequency is 0.6 MHz

Duplex	While receiving	While transmitting
+ (up)		
- (down)		

▨ For the U.S.A. version:

The auto repeater function has priority over the manual duplex setting. If the transmit frequency changes after setting, the auto repeater function may have changed the duplex setting. Turn the auto repeater function OFF to prevent this (p. 23).

◇ Reverse duplex function

When the reverse duplex function is ON, the receive and transmit frequencies are reversed. The function can be set in the Set mode.

- ① Push **[FUNC](*)**, and then **[SET](8)** to enter the Set mode.
- ② Push **[▲]** or **[▼]** to select the reverse duplex function item (REV).
- ③ Rotate **[VOL]** to turn the function ON or OFF.
- ④ Push **[# ENT]** to exit the Set mode.

Each receive and transmit frequency is shown in the table below, with the following configurations;

Input freq. : 145.300 MHz
 Direction : - (down)
 Offset : 0.6 MHz

Reversed	RX freq.	TX freq.
OFF	145.300 MHz	144.700 MHz
ON	144.700 MHz	145.300 MHz

- “-” or “+” blinks when the reverse duplex function is ON.

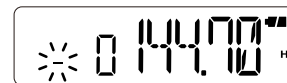

■ Subaudible tones

Some repeaters require subaudible tones to be accessed. Subaudible tones are superimposed over your normal signal, and must be set in advance.

- ① Push **[FUNC](*)** then **[SET](8)** to enter the Set mode.
- ② Push **[▲]** or **[▼]** to select the repeater tone item. (rt)
- ③ Rotate **[VOL]** to select the desired subaudible tone.

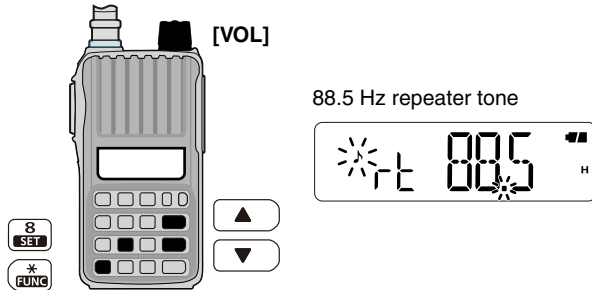

- ④ Push **[# ENT]** to exit the Set mode.

• **Available subaudible tone frequencies** (unit: Hz)

67.0	79.7	94.8	110.9	131.8	156.7	171.3	186.2	203.5	229.1
69.3	82.5	97.4	114.8	136.5	159.8	173.8	189.9	206.5	233.6
71.9	85.4	100.0	118.8	141.3	162.2	177.3	192.8	210.7	241.8
74.4	88.5	103.5	123.0	146.2	165.5	179.9	196.6	218.1	250.3
77.0	91.5	107.2	127.3	151.4	167.9	183.5	199.5	225.7	254.1

◇ Tone information

Some repeaters require a different tone system to be accessed.

DTMF TONES

While pushing **[PTT]**, push the desired DTMF keys, **[0]** to **[9]**, **[MONI](A)**, **[▲](B)**, **[▼](C)**, **[VFO/MR/CALL](D)**, **[*](E)**, and **[# ENT](F)**, to transmit their assigned DTMF codes.

- The transceiver has 16 DTMF memory channels (p. 35).

1750 Hz TONE

To access some European repeaters, the transceiver must transmit a 1750 Hz tone burst.

For IC-V80E only

Push **[PTT]** briefly, push and hold **[PTT]** again for 1 or 2 sec.

For other transceivers

While pushing **[PTT]**, push and hold either the **[▲]** or **[▼]** for 1 or 2 sec. See page 36 for details.

✓ **CONVENIENT!**

Tone scan function:

If you don't know the subaudible tone used for a repeater, the tone scan is convenient for detecting the tone frequency.

- ➡ Push **[FUNC](*)**, and then **[T.SCAN](3)** to start a tone scan.

- When the required tone frequency is detected, the scan pauses, and the tone frequency is temporarily set.
- See page 34 for details of the tone scan function.

5 REPEATER OPERATION

■ Lockout function

The lockout function helps prevent interference to other stations by inhibiting transmitting when the channel is busy. The function can be set in the Initial Set mode.

- ① While pushing and holding [▲] and [▼], turn the power ON to enter the Initial Set mode.
- ② Push [▲] or [▼] to select the lockout item. (RLO)
- ③ Rotate [VOL] to select the lockout function option between OFF, repeater lockout, and busy lockout.
 - “RLO.OF” : Allows transmitting, even if signals are received.
 - “RLO.RP” : The repeater lockout function inhibits transmitting when the channel is busy, except while receiving a signal that includes a matched subaudible tone.
 - “RLO.bU” : The busy lockout function inhibits transmitting while receiving a signal.
- ④ Push [# ENT] to exit the Initial Set mode.

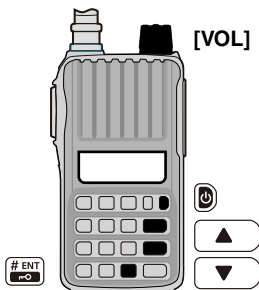

The repeater lockout function is ON.



■ Auto repeater function

U.S.A. version only

The auto repeater function sets the standard repeater settings (duplex ON/OFF, duplex direction, tone encoder ON/OFF) when the operating frequency falls within or outside of the general repeater output frequency range. The offset and repeater tone frequencies are not changed by the auto repeater function. Reset these frequencies, if necessary. The function can be set in the Initial Set mode.

- ① While pushing and holding [▲] and [▼], turn the power ON to enter the Initial Set mode.
- ② Push [▲] or [▼] to select the auto repeater item. (RPt)
- ③ Rotate [VOL] to select a desired option.
 - “Rpt.OF” : Turns the function OFF.
 - “Rpt.R1” : The auto repeater function is activated for duplex only.
 - “Rpt.R2” : The auto repeater function is activated for duplex and tone encoder.
- ④ Push [# ENT] to exit the Initial Set mode.

• Frequency range and offset direction

Frequency range	Duplex direction
145.200 to 145.495 MHz 146.610 to 146.995 MHz	“-” appears.
147.000 to 147.395 MHz	“+” appears.

■ General description

The transceiver has 207 memory channels, including 6 scan edge memory channels (3 pairs), and 1 Call channel, for storage of often-used frequencies.

◇ Memory channel contents

The following information can be programmed into a memory channel:

- Operating frequency (p. 16)
- Operating mode (p. 16)
- Duplex direction (+ or -) with frequency offset (p. 21)
- Reverse duplex function ON/OFF (p. 40)
- Subaudible tone encoder (p. 20), tone squelch or DTCS squelch ON/OFF (p. 33)
- Subaudible tone frequency (p. 22), tone squelch frequency or DTCS code with polarity (pp. 32, 33)
- Skip setting (p. 30)
- Tuning step (p. 16)
- Output power (p. 17)
- TX permission (p. 41)

■ Selecting a memory channel

◇ Using [▲] or [▼]

- ① Push [VFO/MR/CALL] several times to select the memory mode.
 - “MR” appears.
- ② Push [▲] or [▼] to select a desired channel.
 - Only programmed channels are displayed.

◇ Using the keypad

- ① Push [VFO/MR/CALL] several times to select the memory mode.
 - “MR” appears.
- ② To select a desired channel, enter the 3 digits of the channel number using the keypad.
 - Blank channels are also selectable.
 - Entering one or two digits, and then pushing [# ENT] also selects a memory channel.

• Example— selecting memory channel “14”

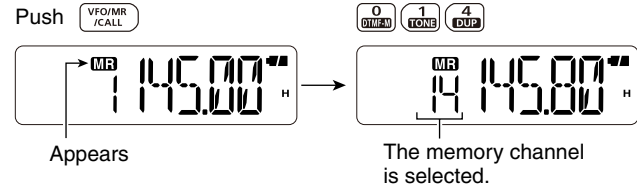

■ Selecting the Call channel

- Push [VFO/MR/CALL] several times to select the Call channel.
 - “C” appears instead of the memory channel number.

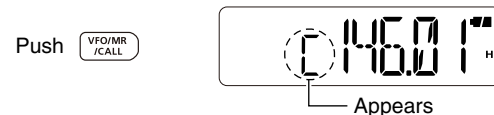

6 MEMORY/CALL OPERATION

■ Channel programming

- ① Push **[VFO/MR/CALL]** several times to select the VFO mode.
- ② Set a desired frequency. (p. 16)
 - ➔ If desired, set other data (e.g. offset frequency, duplex direction, tone squelch, etc.).
- ③ Push **[FUNC](*)**, and then **[VFO/MR/CALL]**.
 - “MR” and the memory channel number blink.
 - Select the Call channel mode to program the Call channel.
- ④ Push **[▲]** or **[▼]** to select a desired channel.
 - Select “1A/1B” to “3A/3B” to program a scan edge channel.
- ⑤ Push **[FUNC](*)**, and then push and hold **[VFO/MR/CALL]** for 1 sec. to store the entry.
 - 3 beeps sound.
 - If you continue to push and hold **[VFO/MR/CALL]** for 1 sec. after programming, the memory channel number automatically increases.

/// **NOTE:** To cancel programming, push **[VFO/MR/CALL]** before storing the entry in step ⑤.

• Example— programming 145.440 MHz into memory channel 11 (a blank channel).

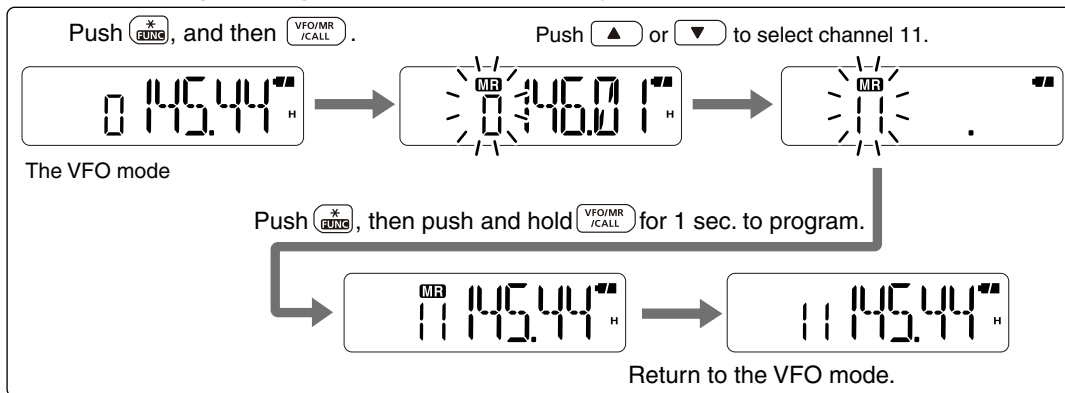
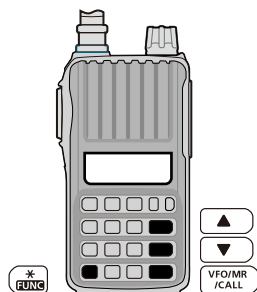

■ Copying memory/Call contents

This function transfers a memory channel's contents to VFO (or another memory/Call channel). This is useful when searching for signals around a memory channel frequency and for recalling the offset frequency, subaudible tone frequency etc.

◇ Memory/Call↔VFO

- ① Select a memory (Call) channel to be copied.
 - ➔ Push [VFO/MR/CALL] several times to select the memory or Call channel mode, and then push [▲] or [▼] to select a desired channel.
- ② Push [FUNC](*), and then push and hold [VFO/MR/CALL] for 1 sec. to transfer the selected memory contents to the VFO mode.
 - The VFO mode is automatically selected.

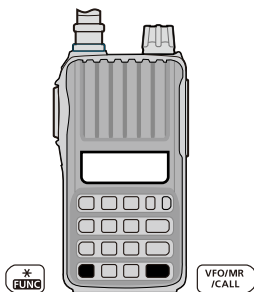

• Example— copying memory channel 11 to the VFO mode.

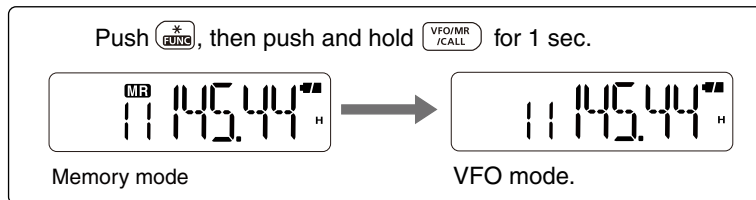

◇ Memory/Call↔memory/Call

- ① Select a memory or Call channel to be copied.
 - ➔ Push [VFO/MR/CALL] several times to select the memory mode or the Call channel mode, and then push [▲] or [▼] to select a desired channel.
- ② Push [FUNC](*), and then push [VFO/MR/CALL].
 - “MR” and “-” blink.
 - Do not hold [VFO/MR/CALL] for more than 1 sec., otherwise the memory contents will be copied to the VFO mode.
- ③ Push [▲] or [▼] to select the target memory or Call channel.
- ④ Push [FUNC](*), and then push and hold [VFO/MR/CALL] for 1 sec. to copy.

■ Clearing memory contents

The contents of programmed memories can be cleared (erased).

- ① For only the U.S.A. version, select any mode other than the weather channel mode.
- ② Push **[FUNC](*)**, and then push **[VFO/MR/CALL]**.
- ③ Push **[▲]** or **[▼]** to select a channel to be cleared.
- ④ Perform the following operation within 1.5 sec., otherwise the transceiver returns to the memory mode without clearing memory.
 - Push **[FUNC](*)**, and then momentarily push **[VFO/MR/CALL]**.
 - Push **[FUNC](*)**, and then push and hold **[VFO/MR/CALL]** for 1 sec.
- ⑤ Push **[VFO/MR/CALL]** to return to the previous mode.

NOTE: Be careful!— the contents of cleared memories **CANNOT** be recalled.

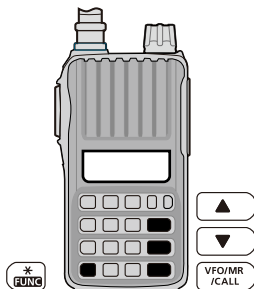

■ Display type

During memory mode operation, the transceiver has 3 display types to suit your operating style.

Set the display type in the Initial Set mode. (p. 46)

“Frequency display”

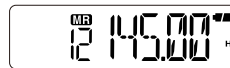

Displays the programmed frequency.

“Channel number display”



Displays the memory channel number. Only programmed channels are displayed, and modes other than the memory mode cannot be selected.

- When the channel number display type is selected, only the following functions can be performed.
 - Scan function (p. 30)
 - DTMF memory function (p. 35)
 - The scan pause timer setting, the function key timer setting, the LCD backlight setting, the VOX-related settings, the microphone gain setting, and the DTMF TX key setting in the Set mode.
 - Out put power setting (p. 17)
 - Key lock function (p. 18)

“Channel name display”



Displays the channel name you have assigned. Only programmed channels are displayed.

- If no channel name is programmed, the programmed frequency will be displayed.
- Push **[MONI]** to display the operating frequency.

■ Programming a channel name

Each memory channel can be programmed with an alphanumeric name for easy recognition and can be displayed independently by channel. Up to 5 characters can be used for a channel name.

- ① While pushing and holding [▲] and [▼], turn the power ON to enter the Initial Set mode.
- ② Push [▲]/[▼] to select the channel name display item. (dSP)
- ③ Rotate [VOL] to select the channel name display type, "dSP.nm."
- ④ Push [# ENT] to exit the Initial Set mode.
- ⑤ Push [VFO/MR/CALL] several times to select the memory mode.
 - Select the Call channel to program a Call channel name.
- ⑥ Push [▲] or [▼] to select a desired channel.
- ⑦ Push [FUNC](*), and then [SET](8) to enter the channel name programming mode.
 - A cursor blinks for the first character.

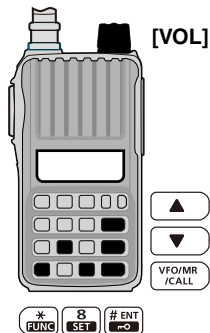

- ⑧ Rotate [VOL] to select a desired character.
 - The selected character blinks.
 - Push [▲] to move the cursor right, push [▼] to move the cursor left.



- ⑨ Repeat step ⑧ until the desired channel name is programmed.
- ⑩ Push [# ENT] to exit the programming mode.

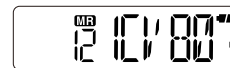

◇ Usable characters

A	b	C	d	E	F	G	H	I	J	k	L	m
(A)	(b)	(C)	(d)	(E)	(F)	(G)	(H)	(I)	(J)	(k)	(L)	(m)

n	O	P	q	R	S	t	U	V	W	X	y	Z
(n)	(O)	(P)	(q)	(R)	(S)	(t)	(U)	(V)	(W)	(X)	(y)	(Z)
1	2	3	4	5	6	7	8	9	0			
(1)	(2)	(3)	(4)	(5)	(6)	(7)	(8)	(9)	(0)			
+	-	=	*	/	(l)	(j)	:	Space				
(+)	(-)	(=)	(*)	(/)	((l))	((j))	(:)					

■ Scan types

A scan automatically searches for signals, and makes it easier to locate new stations for contact or listening purposes.

PROGRAMMED SCAN (See the next topic)

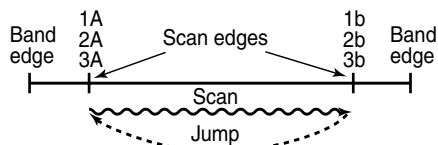

The Programmed scan P1 scans between 1A and 1b, P2 scans between 2A and 2b, and P3 scans between 3A and 3b frequencies.

MEMORY (SKIP) SCAN (p. 30)

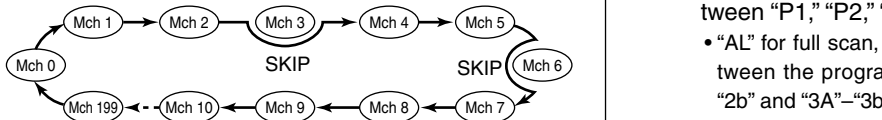

PRIORITY WATCH (p. 31)

• Memory/Call channel watch • Memory scan watch

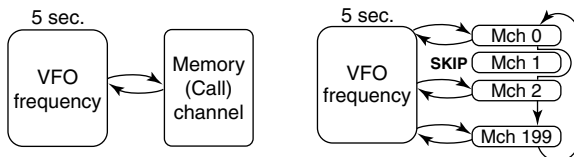

■ Programmed scan

A programmed scan repeatedly scans between two user programmed frequencies (memory channels “1A–3A” and “1b–3b”), or scans between upper and lower band edges. This scan is useful for checking for signals within a specific frequency range, such as repeater output frequencies, etc.

- ① Push **[VFO/MR/CALL]** several times to select the VFO mode.
- ② Push **[FUNC](*)**, and then **[SCAN](5)** to start a scan.

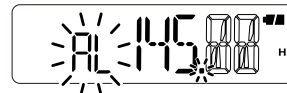

- ③ Push **[FUNC](*)**, and then **[SET](8)** several times to select a desired scan type between “P1,” “P2,” “P3” or “AL.”

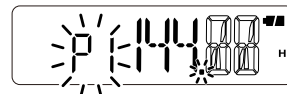

- “AL” for full scan, “P1,” “P2” and “P3” for programmed scan between the programmed scan edge channels “1A”–“1b,” “2A”–“2b” and “3A”–“3b.”
 - To change the scan direction, push **[▲]** or **[▼]**.
- ④ To cancel the scan, push any key except **[⏻]**, **[▲]/[▼]**, **[MONI]** or **[FUNC](*)**.

NOTE: Scan edge channels, 1A–3A/1b–3b, must be programmed in advance. Program them in the same manner as regular memory channels. (p. 25)
If identical frequencies are programmed into the scan edge channels, the programmed scan will not function.

Memory Scan

A memory scan repeatedly scans memory channels, except those set as skip channels.

- ① Push **[VFO/MR/CALL]** several times to select the memory mode.
 - “**MR**” appears.
- ② Push **[FUNC](*)**, then **[SCAN](5)** to start the scan.
 - To change the scan direction, push **[▲]** or **[▼]**.
- ③ To cancel the scan, push any key except **[⏻]**, **[▲]/[▼]**, **[MONI]** or **[FUNC](*)**.

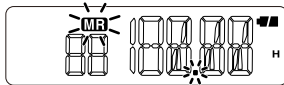

Setting skip channels

In order to speed up the scan rate, you can set the memory channels you don't want to scan as skip channels.

- ① Select a memory channel to be skipped.
 - ➔ Push **[VFO/MR/CALL]** several times to select the memory mode, and then push **[▲]** or **[▼]** to select a desired channel.
- ② Push **[FUNC](*)**, and then **[SKIP](6)** to turn the skip setting ON or OFF.
 - “**SKIP**” appears when the channel is set as a skip channel.

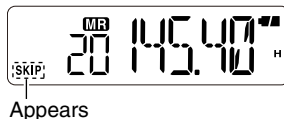

Scan resume setting

When a signal is received during a scan, the scan resume setting determines what action the transceiver takes. The transceiver has 2 scan resume settings, as described below. Use the Set mode to select the one which best suits your needs.

- ① Push **[FUNC](*)**, and then **[SET](8)** to enter the Set mode.
- ② Push **[▲]** or **[▼]** to select the scan pause timer item (SCt, or SCP).
- ③ Rotate **[VOL]** to select a desired scan pause option.
 - **Pause scan**
The scan pauses until the received signal disappears, and then resumes after 2 sec.
 - **Timer scan**
The scan pauses for 5 sec., 10 sec. or 15 sec., and then resumes.
- ④ Push **[# ENT]** to exit the Set mode.

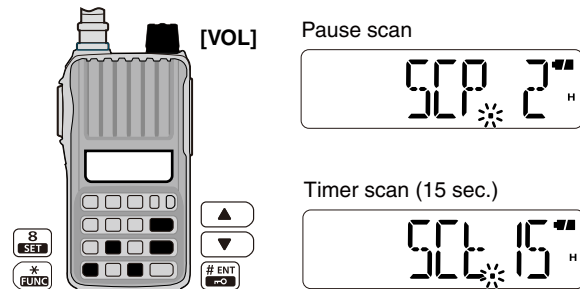

Priority watch

A priority watch checks for signals on “priority channels” while operating on a VFO frequency.

Memory or Call channel watch

While operating on a VFO frequency, the memory or Call channel watch checks for signals on the selected channel every 5 sec.

- ① Select a desired memory channel or the Call channel.
- ② Push **[FUNC](*)**, and then **[PRIO](7)** to start the watch.
 - The decimal point “.”, on the frequency readout blinks.
 - When a signal is detected on the channel, the watch resumes according to the scan resume setting. (p. 30)

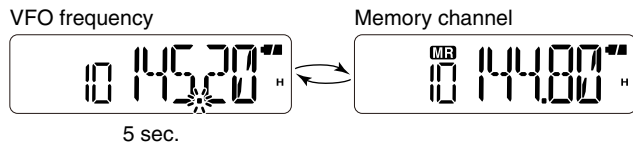

- ③ To cancel the watch, push any key except **[POWER]**, **[▲]/[▼]**, **[MONI]**, **[FUNC](*)**, or **[PTT]**.

Memory scan watch

While operating on a VFO frequency, a memory scan watch checks for signals on each memory channel in sequence, every 5 sec.

- ① Push **[VFO/MR/CALL]** several times to select the memory mode.
- ② Push **[FUNC](*)**, and then **[SCAN](5)** to start a memory scan.
- ③ Push **[FUNC](*)**, and then **[PRIO](7)** to start the watch.
 - The VFO mode is selected, and the decimal point “.”, on the frequency readout blinks.
 - When a signal is detected on a channel, the watch resumes according to the scan resume setting. (p. 30)

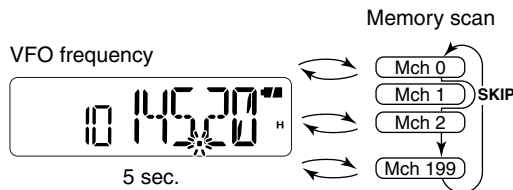

- ④ To cancel the watch, push any key except **[POWER]**, **[▲]/[▼]**, **[MONI]**, **[FUNC](*)**, or **[PTT]**.

■ Tone/DTCS squelch and pocket beep

◇ Tone squelch and DTCS squelch

The tone squelch (CTCSS) or DTCS squelch opens only when receiving a signal that includes a matched CTCSS tone or DTCS code, respectively. You can silently wait for calls using the same tone or code. Separate tone frequencies can be set for repeater and tone squelch/pocket beep operation.

◇ Pocket beep

The pocket beep function uses subaudible tones or DTCS codes for calling, and can be used as a “common pager” to inform you that someone has called while you were away from the transceiver.

• Recommended CTCSS tones (unit: Hz)

67.0	79.7	94.8	110.9	131.8	156.7	186.2	225.7
69.3	82.5	97.4	114.8	136.5	162.2	192.8	233.6
71.9	85.4	100.0	118.8	141.3	167.9	203.5	241.8
74.4	88.5	103.5	123.0	146.2	173.8	210.7	250.3
77.0	91.5	107.2	127.3	151.4	179.9	218.1	

• Recommended DTCS code

023	051	114	143	174	251	315	371	445	532	631	723
025	054	115	152	205	261	331	411	464	546	632	731
026	065	116	155	223	263	343	412	465	565	654	732
031	071	125	156	226	265	346	413	466	606	662	734
032	072	131	162	243	271	351	423	503	612	664	743
043	073	132	165	244	306	364	431	506	624	703	754
047	074	134	172	245	311	365	432	516	627	712	

◇ Setting CTCSS tone or DTCS code

- ① Push **[FUNC](*)**, and then **[SET](8)** to enter the Set mode.
- ② Push **[▲]** or **[▼]** to select the CTCSS tone item (Ct) or the DTCS code item (dt).
 - “Ct” blinks when selecting the CTCSS tone item, and “dt” blinks when selecting the DTCS code item.
- ③ Rotate **[VOL]** to select a desired CTCSS tone or DTCS code.
 - The recommended CTCSS tone or DTCS code are shown to the left.
- ④ Push **[# ENT]** to exit the Set mode.

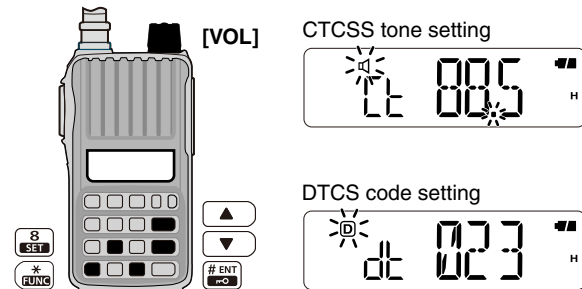

8 TONE SQUELCH AND POCKET BEEP

◇ Setting DTCS polarity

For DTCS operation, the polarity setting is also configurable, as well as the code setting. If the polarity is different, the DTCS squelch never opens, even when receiving a signal that includes a matched DTCS code.

- ① Push **[FUNC](*)**, and then **[SET](8)** to enter the Set mode.
- ② Push **[▲]** or **[▼]** to select the DTCS polarity item (dtP).
- ③ Rotate **[VOL]** to select a desired polarity setting between “dtP.nn” (normal), “dtP.nR” (TX: normal, RX: reverse), “dtP.Rn” (TX: reverse, RX: normal) and “dtP.RR” (reverse).

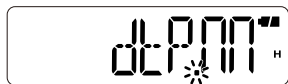

TX/RX: Normal polarity

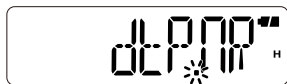

TX: Normal, RX: Reverse



TX: Reverse, RX: Normal



TX/RX: Reverse polarity

- ④ Push **[# ENT]** to exit the Set mode.

◇ Operation

- ① Set a desired operating frequency, and then a CTCSS tone or a DTCS code.
- ② Push **[FUNC](*)**, and then **[TONE](1)**.
 - Repeat step ② several times to activate a desired tone function.

Push **[FUNC](*)**, and then **[TONE](1)** to select the tone function in sequence.

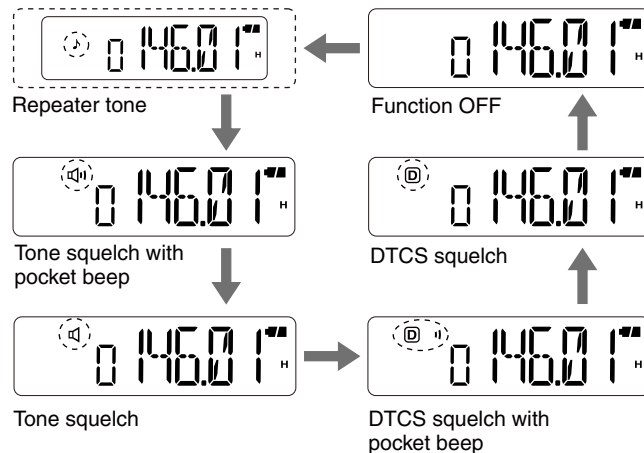

- ③ Operate the transceiver in a normal way.

- ④ When receiving a signal that includes a matched tone or code, the squelch opens and the signal can be heard. When the pocket beep function is activated.
- Beep tones sound and “i” blinks. To stop the beeps and blinking, push any key.
 - When the received signal’s tone/code does not match, the squelch does not open. However, the signal indicator shows the signal strength.
 - To open the squelch manually, push and hold **[MONI]**.
- ⑤ Push **[PTT]** to answer.

■ Tone scan



By monitoring a signal from a repeater, pocket beep or squelch function operation, you can determine the subaudible tone required to access the repeater or open the squelch.

- ① Set a frequency to be checked for a tone frequency or DTCS code.
- ② Push **[FUNC](*)**, and then **[TONE](1)**.
 - Repeat step ② several times to activate a desired tone function.
 - The tone scan can be made even if the tone function is not selected.
- ③ Push **[FUNC](*)**, and then **[T.SCAN](3)** to start a tone scan.
 - To change the scan direction, push **[▲]** or **[▼]**.
- ④ When a tone frequency or DTCS code is matched, the squelch opens and the tone frequency or code is temporarily programmed into the selected mode.
 - When a tone frequency or DTCS code is detected, the tone scan pauses according to the scan resume setting (p. 30)
 - The decoded CTCSS tone frequency or DTCS code is used according to the selected tone function type in step ②.
 - No indication : Cannot be used for operation.
 - “J” : CTCSS tone encoder (repeater tone)
 - “d” : CTCSS tone encoder/decoder
 - “@” : DTCS tone encoder/decoder
- ⑤ To cancel the scan, push any key except **[⏻]**, **[▲]/[▼]**, **[MONI]** or **[FUNC](*)**.

■ Programming a DTMF code sequence



The DTMF codes are used for autopatching, accessing repeaters, controlling other equipment, and other operations. The transceiver has 16 DTMF memory channels (d0–d9, dA, dB, dC, dD, dE, dF) for storage of often-used DTMF code sequence of up to 24 digits.

- ① Push **[FUNC](*)**, and then **[DTMF.M](0)** to enter the DTMF memory mode.

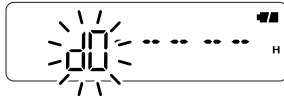
Push , and then .



- ② Push **[▲]** or **[▼]** to select a desired DTMF memory channel.
- If programmed, the previously programmed DTMF code is displayed.
- ③ Push **[FUNC](*)**, and then push and hold **[DTMF.M](0)** for 1 sec. to enter the programming mode.
- “_ _ _ _ _” appears.
 - Programmed memories will be cleared by this operation.

Push , and then push and hold  for 1 sec.

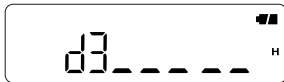

- ④ Push keys to input a desired DTMF code sequence of up to 24 digits.

- **[0]–[9]** inputs “0”–“9,” **[MONI]** inputs “A,” **[▲]** inputs “B,” **[▼]** inputs “C,” **[VFO/MR/CALL]** inputs “D,” **[*]** inputs “*” (E) and **[# ENT]** inputs “# (F).”
- If a digit is mistakenly input, push **[PTT]** momentarily, then repeat from step ③.

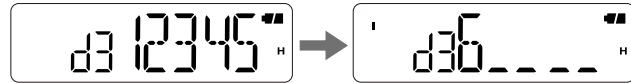





The next page appears when the 6th digit has been input.

- ⑤ Repeat step ④ until the desired code is input.
- ⑥ Push **[PTT]** to store the DTMF code sequence and exit the programming mode.
- After the 24th digit is input, the transceiver automatically stores the code sequence and returns to step ②.
- ⑦ Push **[VFO/MR/CALL]** to exit the DTMF memory.

• Programming mode indication

The programming mode consists of 5 pages.

Page	Digits	Indication
1st	1st to 5th	No indication.
2nd	6th to 10th	“  ” appears.
3rd	11th to 15th	“  ” appears.
4th	16th to 20th	“  ” appears.
5th	21st to 24th	“  ” blinks.

■ Transmitting a DTMF code sequence

The transceiver has 3 methods of transmitting a DTMF code sequence. Select a desired option in the Set mode.

- ① Push **[FUNC](*)**, and then **[SET](8)** to enter the Set mode.
- ② Push **[▲]** or **[▼]** to select the DTMF TX key item (dmt).
- ③ Rotate **[VOL]** to select a desired option.
 - dmt.k : Transmits the appropriate DTMF code assigned to the pushed key.
 - dmt.m : Transmits the programmed DTMF code sequence in the DTMF memory channel assigned to the pushed key.
 - dmt.t : No DTMF code can be transmitted. However, while pushing and holding **[PTT]**, pushing either the **[▲]** or **[▼]** transmits a 1750 Hz tone burst signal.
- ④ Push **[# ENT]** to exit the Set mode.

◇ Manual DTMF code transmission

First, set the DTMF TX key to “dmt.k” in the Set mode.

- While pushing and holding **[PTT]**, push the desired keys to transmit a DTMF code sequence manually.
 - Push **[0]–[9]** for “0”–“9,” **[MONI]** for “A,” **[▲]** for “B,” **[▼]** for “C,” **[VFO/MR/CALL]** for “D,” **[*]** for “*,” and **[# ENT]** for “#.”

◇ Using a DTMF memory channel

First, set the DTMF TX key to “dmt.m” in the Set mode.

- While pushing and holding **[PTT]**, push one of the keys to transmit the programmed DTMF code sequence in the DTMF memory.
 - Pushing **[0]** to **[9]**, **[MONI](A)**, **[▲](B)**, **[▼](C)**, **[VFO/MR/CALL](D)**, **[*](E)**, or **[# ENT](F)** transmits a DTMF code channel (d0–d9, dA, dB, dC, dD, dE or dF) respectively.

◇ 1750 Hz tone

To access some European repeaters, the transceiver must transmit a 1750 Hz tone burst signal.

- This tone can be used as a ‘Call signal’ in countries out of Europe. First, set the DTMF TX key to “dmt.t” in the Set mode.
- While pushing and holding **[PTT]**, push and hold either the **[▲]** or **[▼]** for 1 or 2 sec. to transmit a 1750 Hz tone burst signal.
 - While pushing and holding the key, the tone is transmitted.

■ Confirming a DTMF memory

A DTMF memory can be confirmed with a DTMF tone.

- ① Push [**FUNC**](*) , and then [**DTMF.M**](0) to enter the DTMF memory mode.
- ② Push [**▲**] or [**▼**] to select a desired DTMF memory channel.
- ③ Push [**MONI**] to confirm the DTMF memory contents.
 - The programmed DTMF code sequence sounds.
 - After sounding, the transceiver exits the DTMF memory mode.

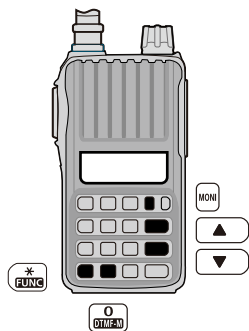

The programmed DTMF code sequence sounds.



Exits the DTMF memory mode.



■ Setting DTMF transfer speed

When slow DTMF transmission speeds are required with DTMF memory transmission (as for some repeaters), the transceiver's rate of DTMF transmission can be adjusted in the Initial Set mode.

- ① While pushing and holding [**▲**] and [**▼**], turn the power ON to enter the Initial Set mode.
- ② Push [**▲**] or [**▼**] to select the DTMF speed item. (dtd)
- ③ Rotate [**VOL**] to select a desired speed.
 - dtd. 1 : 100 msec. interval; 5.0 cps rate
 - dtd. 2 : 200 msec. interval; 2.5 cps rate
 - dtd. 3 : 300 msec. interval; 1.6 cps rate
 - dtd. 5 : 500 msec. interval; 1.0 cps rate

(cps=characters per second)
- ④ Push [**# ENT**] to exit the Initial Set mode.

■ Set mode programming

The Set mode is used to change the settings of the transceiver's functions.

◇ Set mode operation

- ① Push [FUNC](*) , and then [SET](8) to enter the Set mode.
- ② Push [▲] or [▼] to select the desired item.
- ③ Rotate [VOL] to select the option or value.
- ④ To exit the Set mode, push [# ENT].

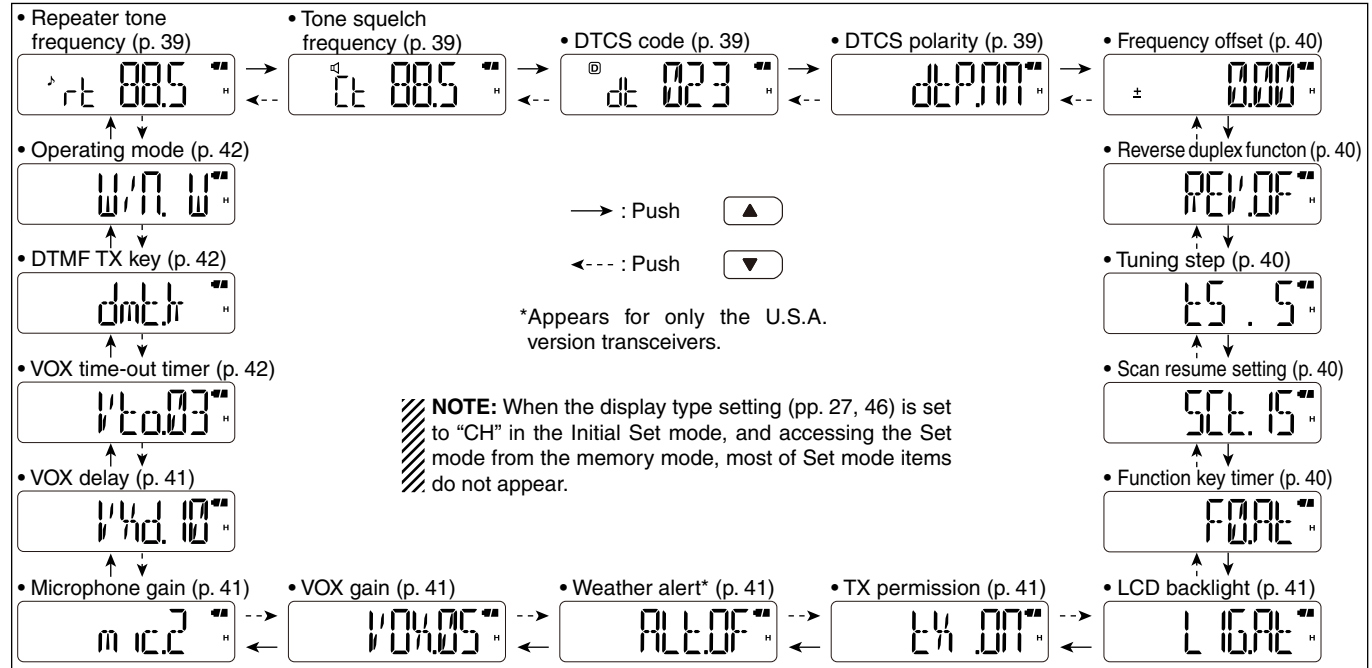

10 SET MODES

■ Set mode items

◇ Repeater tone frequency

Selects one of 50 subaudible tone frequencies used to access the repeaters.

- 67.0–254.1 Hz (default: 88.5 Hz)

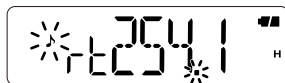
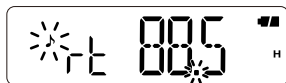

◇ Tone squelch frequency

Selects one of tone frequencies for tone squelch or pocket beep operation.

- 67.0–254.1 Hz (default: 88.5 Hz)

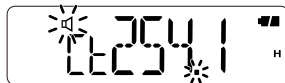
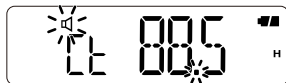

• Usable subaudible tone frequencies (unit: Hz)

67.0	79.7	94.8	110.9	131.8	156.7	171.3	186.2	203.5	229.1
69.3	82.5	97.4	114.8	136.5	159.8	173.8	189.9	206.5	233.6
71.9	85.4	100.0	118.8	141.3	162.2	177.3	192.8	210.7	241.8
74.4	88.5	103.5	123.0	146.2	165.5	179.9	196.6	218.1	250.3
77.0	91.5	107.2	127.3	151.4	167.9	183.5	199.5	225.7	254.1

The transceiver has 50 tone frequencies and consequently their spacing is narrow compared with units having 38 tones. Therefore, some tone frequencies may receive interference from adjacent tone frequencies.

◇ DTCS Code

Selects one of 104 DTCS (both encoder/decoder) codes.

- 023–754 (default: 023)

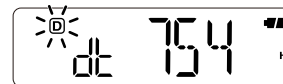

• Available DTCS codes

023	054	125	165	245	274	356	445	506	627	732
025	065	131	172	246	306	364	446	516	631	734
026	071	132	174	251	311	365	452	523	632	743
031	072	134	205	252	315	371	454	526	654	754
032	073	143	212	255	325	411	455	532	662	
036	074	145	223	261	331	412	462	546	664	
043	114	152	225	263	332	413	464	565	703	
047	115	155	226	265	343	423	465	606	712	
051	116	156	243	266	346	431	466	612	723	
053	122	162	244	271	351	432	503	624	731	

◇ DTCS Polarity

Selects the DTCS polarity between “dtP.nn” (normal), “dtP.nR” (TX: normal, RX: reverse), “dtP.Rn” (TX: reverse, RX: normal) and “dtP.RR” (reverse).
(default: dtP.nn)

The DTCS code’s polarity for transmitting or receiving can be independently set by this item.



TX/RX: Normal polarity



TX/RX: Reverse polarity

◇ Frequency offset

Selects the frequency offset between 0 and 20 MHz, for repeater operation.

The frequency offset means the difference between the transmit and receive frequencies.

(default: differs depending on the version)



◇ Reverse duplex function

Turns the reverse duplex function ON or OFF. (default: OFF)



◇ Tuning step

Selects the tuning step from 5, 10, 12.5, 15, 20, 25, 30 and 50 kHz.

(default: differs depending on the version)

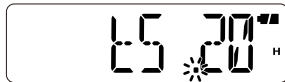

◇ Scan resume setting

Selects the scan resume setting between Sct. 5, Sct. 10, Sct. 15, and SCP. 2.

When a signal is received during a scan, the scan pauses and then resumes, according to the scan resume setting.

- Sct. 5/10/15 : The scan pauses for 5, 10 or 15 sec., and then resumes. (default: Sct. 15)
- SCP.2 : The scan pauses until the received signal disappears, and then resumes after 2 sec.



◇ Function key timer

Push [FUNC](*) to enter the Function mode, and then push a keypad key to activate it's second function.

- During the Function mode, "F" is displayed on the LCD.

Set the time between when Function mode is entered, and how long it remains activated after you push the keypad key to activate it's second function.

- F0.At : Exits the Function mode immediately after a key is pushed to activate it's second function. (default)
- F1/2/3.At : The Function mode remains activated for the selected period after a key is pushed to activate it's second function.
- F.m : The Function mode remains activated until [FUNC](*) is pushed again, even after a key is pushed to activate it's second function.

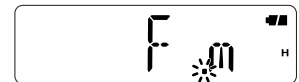
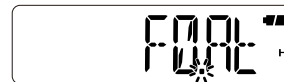

10 SET MODES

◇ LCD backlight

Selects the LCD backlight function.

- LIG.OF : Turns the backlight function OFF.
- LIG.ON : Lights continuously while the transceiver is ON.
- LIG.At : Turns ON when an operation occurs, and turns OFF after 5 sec. (default)

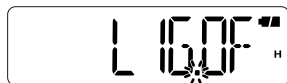

◇ TX permission

Selects whether or not to allow transmitting.

- tX .OF: Inhibits transmitting. (Receive only)
- tX .ON : Allows transmitting. (default)

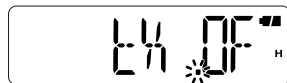
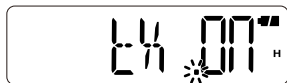

◇ Weather alert

Turns the Weather Alert function ON or OFF. (p. 19)
(default: OFF)

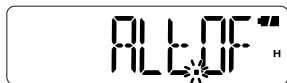

U.S.A. version only

◇ VOX gain

Sets the VOX gain to between 1 and 10. Higher values make the VOX function more sensitive to your voice.

To turn the VOX function OFF, select "VOX.OF:"

(default: VOX.05)

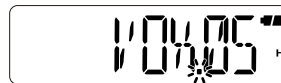

/// **NOTE:** Set the microphone gain before setting the VOX gain. See page 52 for details of the VOX function.

◇ Microphone gain

Sets the microphone gain to between 1 and 4 to suit your preference. Higher values make the microphone more sensitive to your voice.
(default: mic.2)



/// **NOTE:** When using the VOX function, we recommend setting the microphone gain to 3. However, you can adjust it to suit your operating environment (including your headset performance).

◇ VOX delay

Sets the VOX Delay to between “VXd.05” (0.5 sec.), “VXd.10” (1 sec.), “VXd.15” (1.5 sec.), “VXd.20” (2 sec.), “VXd.25” (2.5 sec.) and “VXd.30” (3 sec.).

The VOX Delay is the amount of time the transmitter stays ON after you stop speaking. (default: VXd.10)



◇ VOX time-out timer

Sets the VOX time-out timer to between 1, 2, 3, 4, 5, 10 and 15 min. to prevent accidental prolonged transmission for the VOX function.

To turn the function OFF, select “Vto.OF” (default: Vto.03)



▨ The VOX time-out timer must be set shorter than the time-out timer, otherwise this timer will not be activated.

◇ DTMF TX key

Selects the method to transmit a DTMF code sequence. While pushing and holding [PTT], push one of the keys, [0] to [9], [MONI](A), [▲](B), [▼](C), [VFO/MR/CALL](D), [*](E), and [# ENT](F).

- dmt.k : Transmits the appropriate DTMF code assigned to the key. (default)
- dmt.m : Transmits the programmed DTMF code sequence in the DTMF memory channel assigned to the key.
- dmt.t : No DTMF code can be transmitted. However, while pushing and holding [PTT], push either the [▲] or [▼] to transmit a 1750 Hz tone burst signal.



◇ Operating mode

Set the operating mode to FM or FM-N. The operating mode is determined by the modulation of the radio signals.

(default: W/n. W)



FM mode



FM-N mode

10 SET MODES

Initial Set mode programming

The Initial Set mode can be accessed at power ON and allows you to set seldom-changed settings, to suit your preference and operating style.

◆ Initial Set mode operation

- ① While pushing and holding [▲] and [▼], turn the power ON to enter the Initial Set mode.
- ② Push [▲] or [▼] to select the desired item.
- ③ Rotate [VOL] to select the option or value.
- ④ To exit the Initial Set mode, push [# ENT].

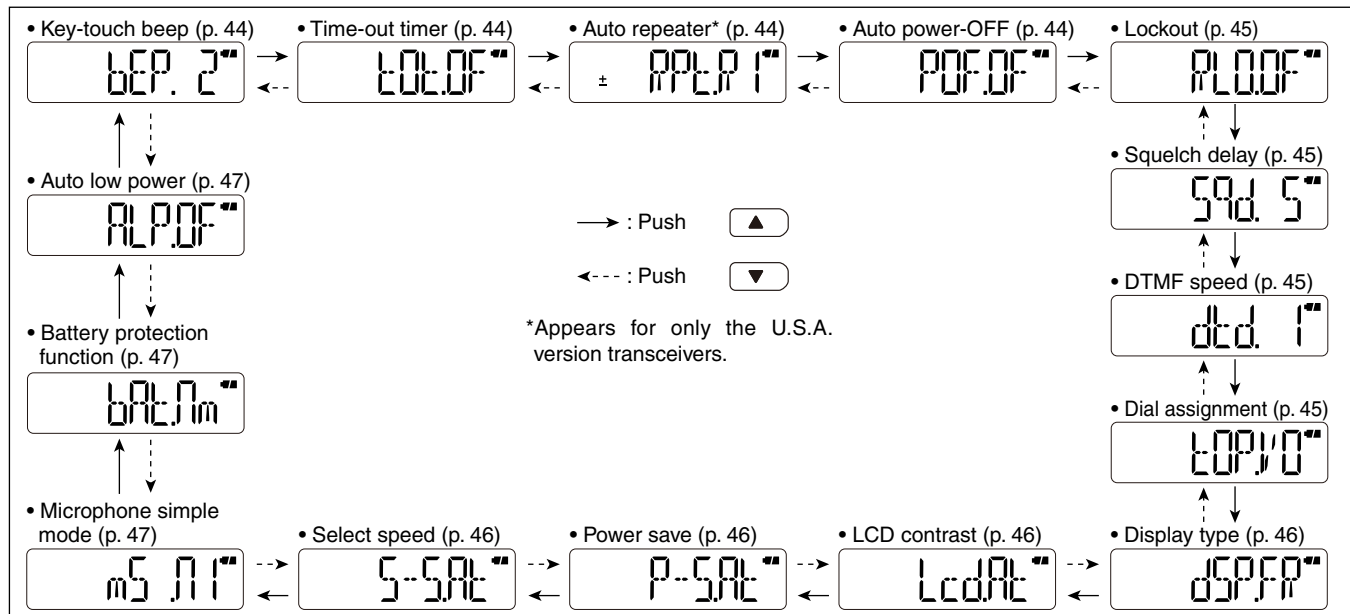

■ Initial Set mode items

◇ Key-touch beep

Turns the key-touch beep ON (the beep level 1 to 3) or OFF.

- When changing the beep level, beeps sound at the level.

(default: bEP. 2)



◇ Time-out timer

To prevent accidental prolonged transmission, the transceiver has a time-out timer. This function cuts transmission OFF after 1–30 min. of continuous transmission.

To turn the function OFF, select “tot.OF” (default: tot. 5)

- tot.OF : Turns the function OFF.
- tot. 1–30 : If continuous transmission exceeds the selected period, the transmission will be cut off.



/// Approx. 10 sec. before the time-out timer is activated, the transceiver emits a beep tone as a warning.

/// **Be careful!** When using the BP-263 battery case, the batteries will become hot if this time-out timer function is turned OFF or set to a long time period, and transmission is made for long periods.

◇ Auto repeater

U.S.A. version only

The Auto Repeater function automatically turns ON or OFF the duplex operation and the tone encoder. The offset and the repeater tone are not changed by the function. Reset these settings, if necessary.

- RPt.OF : Turns the function OFF.
- RPt.R1 : Activates for only duplex. (default)
- RPt.R2 : Activates for both duplex and tone.



◇ Auto power-OFF

The transceiver can be set to beep and automatically turn OFF, when no key operation occurs during a specified period.

- POF.OF : Turns the function OFF. (default)
- POF.30/1H/2H : The transceiver is automatically turned OFF when no operation occurs during the selected period.



/// **NOTE:** The setting is maintained even after the transceiver is turned OFF by the auto power-OFF function. To cancel the function, select “POF.OF”

10 SET MODES

◇ Lockout

Selects the lockout type between repeater, busy and OFF.

- RLO.OF : Turns the function OFF (default).
- RLO.RP : The repeater lockout function inhibits transmitting when the channel is busy, except while receiving a signal that includes a matched tone.
- RLO.bU : The busy lockout function inhibits transmitting while receiving a signal.

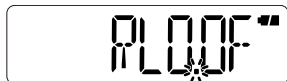

◇ Squelch delay

Sets the squelch delay between short and long. The delay prevents the squelch from repeatedly opening and closing while receiving the same signal.

- Sqd. S : Sets the squelch delay to short (default).
- Sqd. L : Sets the squelch delay to long.

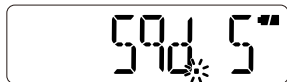

◇ DTMF speed

Selects a desired DTMF transfer speed.

- dtd. 1 : 100 msec. interval; 5.0 cps rate (default)
 - dtd. 2 : 200 msec. interval; 2.5 cps rate
 - dtd. 3 : 300 msec. interval; 1.6 cps rate
 - dtd. 5 : 500 msec. interval; 1.0 cps rate
- (cps=characters per second)



◇ Dial assignment

Selects whether or not to use [VOL] as a tuning control instead of [▲] and [▼]. When [VOL] functions as a tuning control, [▲] and [▼] function as volume controls.

- tOP.VO : Audio volume control (default)
- tOP.di : Tuning dial



/// [VOL] and [▲]/[▼] function as described below, depending on the option.

Option	[VOL]	[▲]/[▼]
tOP.VO	Volume control	Tuning controls
tOP.di	Tuning control	Volume controls

◇ Display type

Selects the display type for memory mode operation.

- dSP.FR : Displays the programmed frequency. (default)
- dSP.CH : Displays the memory channel number. Operable functions, configurable items in the Set mode, and selectable modes will be restricted.
- dSP.nm : Displays the channel name. If no memory name is programmed, the programmed frequency will be displayed.



◇ LCD contrast

Selects the LCD contrast.

- Lcd.LO : Sets the contrast to low.
- Lcd.At : Sets the contrast to high. However, if the transceiver is exposed to high temperatures, it automatically sets the contrast to low. (default)



◇ Power save

The power save function allows you conserve battery life by selecting the duty cycle of the receiver. Select the ratio of the power save time to the standby time.

To turn the function OFF, select "P-S.OF"

- P-S.OF : Turns the function OFF.
- P-S. 2 : Sets the duty cycle to 1:2.
- P-S. 8 : Sets the duty cycle to 1:8.
- P-S.16 : Sets the duty cycle to 1:16.
- P-S.At : Automatically sets the duty cycle. (default)

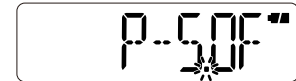
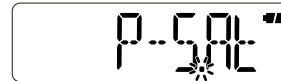

◇ Select speed

The tuning speed acceleration automatically speeds up the tuning speed when rotating [VOL] rapidly.

- S-S. m : Turns the tuning speed acceleration OFF.
- S-S. At : Turns the tuning speed acceleration ON. (default)

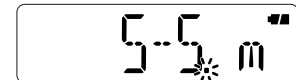
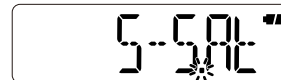

10 SET MODES

◇ Microphone simple mode

Microphone simple mode is used to assign the essential operations to the four switches (S1 to S4) on the remote control unit.

• mS .Sm

S1	Selects the Call channel.
S2	Turns the monitor function ON or OFF.
S3	Selects memory channel 0.
S4	Selects memory channel 1.

• mS .n1 (default)

S1	Toggles the VFO mode and the memory mode.
S2	Selects the Call channel.
S3	Frequency or memory channel "UP"
S4	Frequency or memory channel "DOWN."

• mS .n2

S1	Toggles the VFO mode and the memory mode.
S2	Turns the monitor function ON or OFF.
S3	Frequency or memory channel "UP"
S4	Frequency or memory channel "DOWN."

• User remote control unit

The below circuit is for reference only.

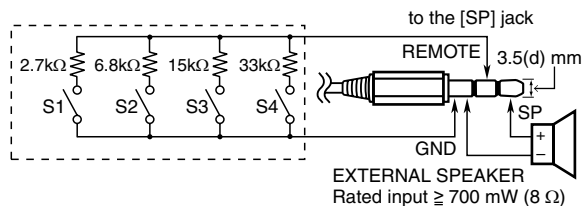

◇ Battery protection

When the battery voltage decreases, the battery protection function automatically turns the transceiver OFF. Select the function according to your battery type.

(default: differs depending on the version)

- bAt.OF : Turns the function OFF. Select when you use the BP-263 battery case.
- bAt.nm : Select when you use the BP-264 Ni-MH battery pack.
- bAt.LI : Select when you use the BP-265 Li-Ion battery pack.



/// **NOTE: BE SURE** to select an appropriate option according to your battery type.

◇ Auto low power

Turns the auto low power function ON or OFF.

When the temperature goes below 0°C (+32°F), the function automatically sets the output power to low.

In that case, the transmit power selections (Hi/Mid) are also disabled.
(default: ALP.OF)



■ Cloning operation

Cloning allows you to quickly and easily transfer the programmed contents from one transceiver to another.

◇ Transceiver-to-transceiver cloning

- Turn the transceiver's power OFF, and then connect an optional OPC-474 cloning cable to the [SP] jacks of the master transceiver and the sub transceiver.
 - The master transceiver is used to send data to the sub transceiver.

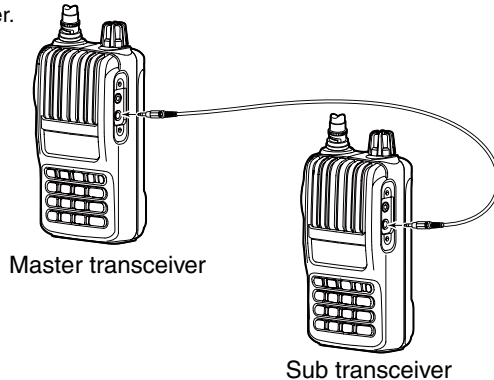

- While pushing [FUNC](*) and [▲], turn the master transceiver ON to enter the cloning mode.
 - "CLONE" appears



- Turn the sub transceiver ON.
- Push [PTT] on the master transceiver.
 - "CL Out" appears on the master transceiver's display, and the signal indicator shows the data is being transferred to the sub transceiver.
 - "CL In" appears on the sub transceiver's display, and the signal indicator shows the data is being received from the master transceiver.
- When cloning is finished, turn both the transceivers OFF. Then turn them ON again to exit the cloning mode.

/// **NOTE:** DO NOT push [PTT] on the sub transceiver during cloning. This will cause a cloning error.

◇ Cloning using a PC

The CS-V80 cloning software is also used to clone/edit contents with a PC (for Microsoft® Windows® 2000/XP or Windows Vista®) using ICF format files.

Refer to the INSTRUCTIONS and the Help file that come with the CS-V80, for details.

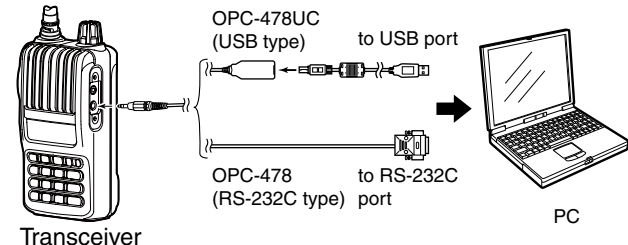

12 RESETTING

■ Resetting

The LCD may occasionally display erroneous information (e.g. when first applying power). This may be caused externally by static electricity or by other factors. If this problem occurs, turn power OFF. After waiting a few seconds, turn power ON again. If the problem persists, perform either or both of the procedures below.

◇ Partial reset

If you want to reset the operating conditions (VFO frequency, VFO settings, and Set modes contents) without clearing the memory contents, use the partial reset.

- ① Push and hold [⏻] for 1 sec. to turn the power OFF.
- ② While pushing and holding [VFO/MR/CALL], push and hold [⏻] for 1 sec. to turn the power ON.

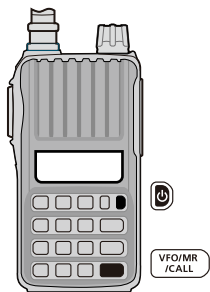

/// **NOTE:** No message appears on the display after the partial reset is done.

◇ All reset

The all reset clears all programming and returns all settings to their factory defaults.

- ① Push and hold [⏻] for 1 sec. to turn the power OFF.
- ② While pushing and holding [MONI] and [VFO/MR/CALL], push and hold [⏻] for 1 sec. to turn the power ON.
 - “CLEAR” appears when resetting the CPU.

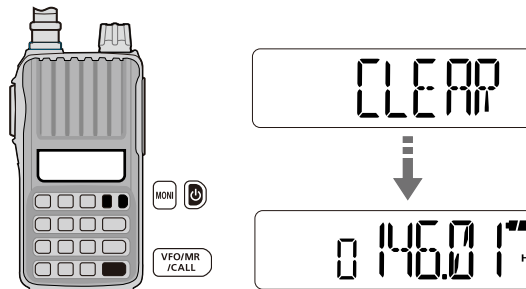

/// **CAUTION:** The all reset returns all programmed contents to their default settings.

If your transceiver seems to be malfunctioning, please check the following points before sending it to a service center.

PROBLEM	POSSIBLE CAUSE	SOLUTION	REF.
The transceiver does not turn ON.	<ul style="list-style-type: none"> The battery is exhausted. The battery polarity is reversed. Loose connection of a battery pack/case. 	<ul style="list-style-type: none"> Charge the battery pack, or replace the batteries. Check the battery polarity. Clean battery terminals. 	pp. 11–13 p. 13 p. 13
No sound comes from the speaker.	<ul style="list-style-type: none"> Volume is too low. An external speaker or a cloning cable is connected to the [SP] jack. 	<ul style="list-style-type: none"> Rotate [VOL] to adjust to a desired level. Check the external speaker connection or remove the cloning cable. 	p. 14 –
Transmitting is impossible.	<ul style="list-style-type: none"> The battery is exhausted. TX permission is inhibited. 	<ul style="list-style-type: none"> Charge the battery pack, or replace the batteries. Set the TX permission setting to “ON” in the Set mode. 	pp. 11–13 p. 41
Transmitting using the VOX function is impossible.	<ul style="list-style-type: none"> The VOX gain is set to OFF or too low. The microphone gain is too low. 	<ul style="list-style-type: none"> Set the VOX gain to a suitable level. Set the microphone gain to a suitable level. 	pp. 41, 53 p. 41
Contacting with another station is impossible.	<ul style="list-style-type: none"> A different tone or code is used for the tone/DTCS squelch. 	<ul style="list-style-type: none"> Check the tone/DTCS by performing a tone scan. 	p. 34
Frequency cannot be set.	<ul style="list-style-type: none"> The key lock function is activated. The memory mode, Call channel mode, or weather channel mode is selected. 	<ul style="list-style-type: none"> Push [FUNC](*), then push and hold [\square] (# ENT) for 1 sec. to cancel the key lock function. Push [VFO/MR/CALL] several times to select the VFO mode. 	p. 18 p. 15
A programmed scan does not start.	<ul style="list-style-type: none"> The memory mode, Call channel mode, or weather channel mode is selected. The same frequency has been programmed in the scan edge channels, “XA”–“Xb.” 	<ul style="list-style-type: none"> Push [VFO/MR/CALL] several times to select the VFO mode. Program different frequencies in the scan edge channels. 	p. 15 p. 25
A memory scan does not start.	<ul style="list-style-type: none"> The VFO mode or Call channel mode is selected. Only one or no memory channel has been programmed. 	<ul style="list-style-type: none"> Push [VFO/MR/CALL] several times to select the memory mode. Program 2 or more memory channels. 	p. 15 p. 25
The displayed frequency is erroneous.	<ul style="list-style-type: none"> The CPU has malfunctioned. External factors have caused a fault. 	<ul style="list-style-type: none"> Reset the transceiver. Remove and re-attach the battery pack/case. 	p. 49 p. 2

14 OPTIONS

- **BP-263** BATTERY CASE
Battery case for LR6 (AA) × 6 alkaline batteries.
- **BP-264** NI-MH BATTERY PACK
7.2 V/1400 mAh (Typ.) Ni-MH battery pack. Battery life: 13 hrs. (approx.; FM, high power, Tx : Rx : Standby = 5:5:90)
- **BP-265** LI-ION BATTERY PACK
7.4 V/1900 mAh (Min.)/2000 mAh (Typ.) Lithium Ion battery pack. Battery life: 19 hrs. (approx.; FM, high power, Tx : Rx : Standby = 5:5:90)
- **BC-191** DESKTOP CHARGER+**BC-123S** AC ADAPTER
For rapid charging of the Ni-MH battery pack. An AC adapter may be supplied with the charger, depending on the version. Charging time: approx. 2 hours for the BP-264.
- **BC-192** DESKTOP CHARGER+**BC-147S** AC ADAPTER
For regular charging of the Ni-MH battery pack. An AC adapter may be supplied with the charger, depending on the version. Charging time: approx. 16 hours for the BP-264.
- **BC-193** DESKTOP CHARGER+**BC-123S** AC ADAPTER
For rapid charging of the Li-Ion battery pack. An AC adapter may be supplied with the charger, depending on the version. Charging time: approx. 2.5 hours for the BP-265.
- **CP-23L** CIGARETTE LIGHTER CABLE
Allows charging of the battery packs through a 12 V cigarette lighter socket. (For only BC-191/BC-193)
- **OPC-515L** DC POWER CABLE
Allows charging of the battery packs using a 12 V DC power source instead of the AC adapter. (For all chargers)
- **MB-124** BELT CLIP
Exclusive alligator-type belt clip.
- **FA-B2E** VHF ANTENNA
The same antenna that is supplied with the transceiver.
- **HM-153L** EARPHONE-MIROPHONE
Ideal for hands-free operation: clip the HM-153L (with integrated PTT switch) to your lapel or breast pocket.
- **HM-158L/HM-159L** SPEAKER-MIROPHONE
Combination speaker-microphone that provides convenient operation while hanging the transceiver on your belt.
- **HS-94/HS-95/HS-97** HEADSET+**OPC-2004** PLUG ADAPTER CABLE
HS-94 : Ear hook type
HS-95 : Neck & arm type
HS-97 : Throat microphone
OPC-2004 : Allows you to connect the HS-94/HS-95/HS-97 to the transceiver. After connecting, the VOX function can be used.
- **SP-27** TUBE EARPHONE
Provides clear audio in noisy environments.
- **CS-V80** CLONING SOFTWARE+**OPC-478/OPC-478UC** CLONING CABLE
Provides quick and easy programming of such settings as memory channels and Set modes contents.
- **OPC-474** CLONING CABLE
For transceiver-to-transceiver cloning.

Some options may not be available in some countries. Please ask your dealer for details.

■ VOX function

The transceiver has a VOX function, which allows hands-free operation.

An optional HS-94, HS-95 or HS-97 headset and the OPC-2004 plug adapter cable are also required for operation.

- The VOX (voice operated transmission) function starts transmission when you speak into the microphone, without needing to push [PTT]; then, automatically returns to reception when you stop speaking.

◇ Optional unit connection

- ① Push and hold [⏻] for 1 sec. to turn the power OFF.
- ② Remove the jack cover. (p. 2)
- ③ Connect the optional HS-94, HS-95 or HS-97 and OPC-2004, as illustrated below.

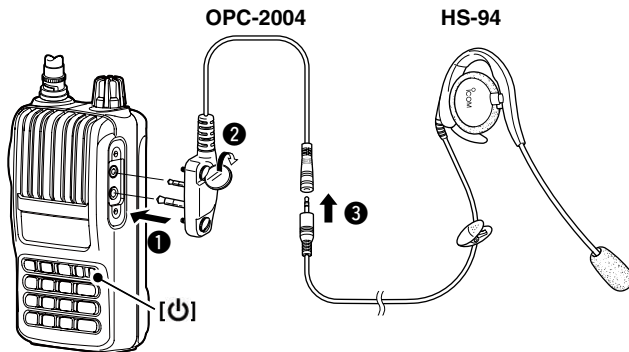

◇ Turning the VOX function ON or OFF

- ① Connect an optional headset and plug adapter cable to the transceiver, and then turn the power ON.
- ② Push [FUNC](*) , and then [VOX](2) to turn the VOX function ON or OFF.
 - “VOX” appears when the VOX function is ON.

NOTE:

- When using the VOX function, adjust the microphone gain and the VOX-related settings (p. 53) to suit your operating environment (including your headset performance).
- Set the microphone gain before setting the VOX gain in the Set mode (p. 41). We recommend setting the microphone gain to 3.
- When the TX permission is set to “OFF” in the Set mode, you cannot transmit using the VOX function. (p. 41)

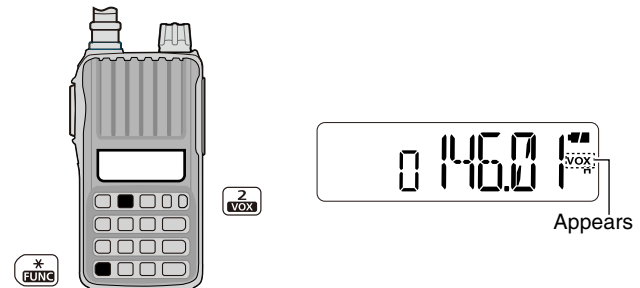

14 OPTIONS

◇ VOX-related settings

The VOX gain, the VOX delay, and the VOX time-out timer can be set in the Set mode.

- ① Connect an optional headset and plug adapter cable to the transceiver, and then turn the power ON.
- ② Push **[FUNC](*)**, and then **[VOX](2)** to turn the VOX function ON.
- ③ Push **[FUNC](*)**, and then **[SET](8)** to enter the Set mode.
- ④ Push **[▲]** or **[▼]** to select the VOX gain (VOX), the VOX delay (VXd), or the VOX time-out timer (Vto) item.
- ⑤ Rotate **[VOL]** to select a desired option.
- ⑥ Push **[# ENT]** to exit the Set mode.

/// The VOX function does not activate transmission while in the Set mode.

• VOX gain

The VOX gain level can be adjusted between 1 (minimum) and 10 (maximum), or turned OFF. Higher values make the VOX function more sensitive to your voice. (default: VOX.05)



The VOX function is turned OFF.



The VOX gain is set to 10 (maximum).

➔ While speaking into the headset microphone, adjust the VOX gain until “On” continuously appears on the LCD.



/// If “On” is intermittent, be sure the VOX delay is set long enough to allow normal pauses in speech, but keep the VOX ON until you finish speaking.

✓ CONVENIENT!

While transmitting using the VOX function, you can adjust the VOX gain simply by rotating **[DIAL]**.

• VOX delay

Sets the VOX delay to between 0.5 and 3.0 sec. (in 0.5 sec. steps). The VOX delay is the amount of time the transmitter stays ON after you stop speaking. (default: VXd.10)



The VOX delay is set to 1 sec.

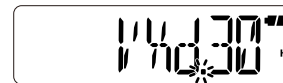

The VOX delay is set to 3 sec.

• VOX time-out timer

Sets the VOX time-out timer to between 1, 2, 3, 4, 5, 10 and 15 min. to prevent accidental prolonged transmission for the VOX function.

To turn the function OFF, select “Vto.OF” (default: Vto.03)

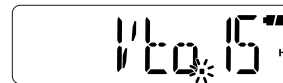
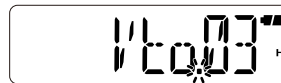

/// The VOX time-out timer must be set shorter than the time-out timer, otherwise this timer will not be activated.

◇ General

- Frequency coverage : (unit: MHz)

Version	TX	RX
U.S.A. AUS	144–148	136–174*
CHN EXP	136–174*	136–174*
EUR UK KOR	144–146	144–146

* Guaranteed: Only 144–148 MHz range

- Mode : FM, FM-N
- Number of memory channels : 207
(incl. 6 scan edges and 1 Call channel)
- Usable temperature range : –20°C to +60°C; –4°F to +140°F
- Tuning steps : 5, 10, 12.5, 15, 20, 25, 30 and 50 kHz
- Frequency stability : ±2.5 ppm
(–20°C to +60°C; –4°F to +140°F)
- Power supply : Icom specified battery pack/case
- Current drain (at 7.2 V DC: typical)
 - Transmit at 5.5 W (High) : 1.4 A
 - at 2.5 W (Mid.) : 0.9 A
 - at 0.5 W (Low) : 0.6 A
 - Receive standby : 65 mA
 - power save : 20 mA
 - max. audio : 310 mA (internal speaker)
180mA (external speaker)
- Antenna connector : BNC (50 Ω)

- Dimensions : 58(W)×112(H)×30(D) mm;
(projections not included) 2⁹/₃₂(W)×4¹³/₃₂(H)×1³/₁₆(D) in
- Weight (approx.)
(without battery pack/case and ant.) : 140 g; 4.9 oz

◇ Transmitter

- Modulation system : Variable reactance freq. modulation
- Output power (at 7.2 V DC) : High 5.5 W, Mid. 2.5 W, Low 0.5 W.
- Max. frequency deviation : FM (wide) ±5.0 kHz
FM (narrow) ±2.5 kHz
- Spurious emissions : Less than –60 dBc
- External mic. connector : 3-conductor 2.5 (d) mm (1/16")/2.2 kΩ

◇ Receiver

- Receive system : Double-conversion superheterodyne
- Intermediate frequencies : 1st: 21.7 MHz, 2nd: 450 kHz
- Sensitivity (at 12 dB SINAD) : –0.14 μV typ.
- Squelch sensitivity (threshold) : –0.1 μV typ.
- Selectivity : FM (wide) 70 dB typ.
FM (narrow) 50 dB typ.
- Spurious and image rejection : 75 dB typ.
- Intermodulation : FM (wide) 70 dB typ.
FM (narrow) 65 dB typ.
- Audio output power (at 10% distortion)
 - Internal speaker : 0.75 W typ. with a 16 Ω load
 - External speaker : 0.45 W typ. with a 8 Ω load
- External speaker connector : 3-conductor 3.5(d) mm; (1/8")/8 Ω

All stated specifications are subject to change without notice or obligation.

IMPORTANT

- When transmitting with a portable radio, hold the radio in a vertical position with its microphone 2.5 to 5 centimetres from your head and body.
- If you wear a portable two-way radio on your body, ensure that the antenna is at least 2.5 centimetres from your body when transmitting.



CE Versions of the IC-V80E which display the 'CE' symbol on the serial number label, comply with the essential requirements of the European Radio and Telecommunication Terminal Directive 1999/5/EC.



This warning symbol indicates that this equipment operates in non-harmonised frequency bands and/or may be subject to licensing conditions in the country of use. Be sure to check that you have the correct version of this radio or the correct programming of this radio, to comply with national licensing requirements.

• List of Country codes (ISO 3166-1)

	Country	Codes		Country	Codes
1	Austria	AT	18	Liechtenstein	LI
2	Belgium	BE	19	Lithuania	LT
3	Bulgaria	BG	20	Luxembourg	LU
4	Croatia	HR	21	Malta	MT
5	Czech Republic	CZ	22	Netherlands	NL
6	Cyprus	CY	23	Norway	NO
7	Denmark	DK	24	Poland	PL
8	Estonia	EE	25	Portugal	PT
9	Finland	FI	26	Romania	RO
10	France	FR	27	Slovakia	SK
11	Germany	DE	28	Slovenia	SI
12	Greece	GR	29	Spain	EP
13	Hungary	HU	30	Sweden	SE
14	Iceland	IS	31	Switzerland	CH
15	Ireland	IE	32	Turkey	TR
16	Italy	IT	33	United Kingdom	GB
17	Latvia	LV			



We Icom Inc. Japan
1-1-32, Kamiminami, Hirano-ku
Osaka 547-0003, Japan

Declare on our sole responsibility that this equipment complies with the essential requirements of the Radio and Telecommunications Terminal Equipment Directive, 1999/5/EC, and that any applicable Essential Test Suite measurements have been performed.

Kind of equipment: VHF TRANSCEIVER

Type-designation: IC-V80E

Version (where applicable): _____

This compliance is based on conformity with the following harmonised standards, specifications or documents:

- i) EN 301 489-1 v1.8.1 (Apr. 2008)
- ii) EN 301 489-15 v1.2.1 (Aug. 2002)
- iii) EN 301 783-2 v1.1.1 (Sep. 2000)
- iv) EN 60950-1 (2001): A11: 2004

DECLARATION OF CONFORMITY



Düsseldorf 16th Oct. 2009

Place and date of issue

Icom (Europe) GmbH
Himmelgeister straÙe 100
D-40225 Düsseldorf

Authorized representative name

Y. Furukawa
General Manager

Signature

Icom Inc.

Count on us!

#02 Europe

#12 Europe-21

#22 Europe-22

#32 Europe-23

<Intended Country of Use>	
<input checked="" type="checkbox"/> AT	<input checked="" type="checkbox"/> BE <input checked="" type="checkbox"/> CY <input checked="" type="checkbox"/> CZ <input checked="" type="checkbox"/> DK <input checked="" type="checkbox"/> EE
<input checked="" type="checkbox"/> FI	<input checked="" type="checkbox"/> FR <input checked="" type="checkbox"/> DE <input checked="" type="checkbox"/> GR <input checked="" type="checkbox"/> HU <input checked="" type="checkbox"/> IE
<input checked="" type="checkbox"/> IT	<input type="checkbox"/> LV <input checked="" type="checkbox"/> LT <input checked="" type="checkbox"/> LU <input checked="" type="checkbox"/> MT <input checked="" type="checkbox"/> NL
<input checked="" type="checkbox"/> PL	<input checked="" type="checkbox"/> PT <input checked="" type="checkbox"/> SK <input checked="" type="checkbox"/> SI <input checked="" type="checkbox"/> ES <input checked="" type="checkbox"/> SE
<input type="checkbox"/> GB	<input type="checkbox"/> IS <input checked="" type="checkbox"/> LI <input type="checkbox"/> NO <input type="checkbox"/> CH <input checked="" type="checkbox"/> BG
<input checked="" type="checkbox"/> RO	<input type="checkbox"/> TR <input type="checkbox"/> HR

#13 U.K.-01

#23 U.K.-02

#33 U.K.-03

<Intended Country of Use>	
<input type="checkbox"/> AT	<input type="checkbox"/> BE <input type="checkbox"/> CY <input type="checkbox"/> CZ <input type="checkbox"/> DK <input type="checkbox"/> EE
<input type="checkbox"/> FI	<input type="checkbox"/> FR <input type="checkbox"/> DE <input type="checkbox"/> GR <input type="checkbox"/> HU <input type="checkbox"/> IE
<input type="checkbox"/> IT	<input type="checkbox"/> LV <input type="checkbox"/> LT <input type="checkbox"/> LU <input type="checkbox"/> MT <input type="checkbox"/> NL
<input type="checkbox"/> PL	<input type="checkbox"/> PT <input type="checkbox"/> SK <input type="checkbox"/> SI <input type="checkbox"/> ES <input type="checkbox"/> SE
<input checked="" type="checkbox"/> GB	<input type="checkbox"/> IS <input type="checkbox"/> LI <input type="checkbox"/> NO <input type="checkbox"/> CH <input type="checkbox"/> BG
<input type="checkbox"/> RO	<input type="checkbox"/> TR <input type="checkbox"/> HR

A-6795H-1EX-②

Printed in Japan

© 2009–2010 Icom Inc.

Printed on recycled paper with soy ink.

Icom Inc.

1-1-32 Kamiminami, Hirano-ku, Osaka 547-0003, Japan