



OPERATING GUIDE

VHF P25 TRANSCEIVERS

IC-F7010 series

IC-F7510 series

UHF P25 TRANSCEIVERS

IC-F7020 series

IC-F7520 series

INTRODUCTION

1 ACCESSORIES

2 PANEL DESCRIPTION

3 BASIC OPERATION

4 ADVANCED OPERATION

5 SCAN OPERATION

6 MENU SCREEN

7 APCO P25 MODE OPERATION

8 MDC 1200 SYSTEM OPERATION

9 ABOUT THE microSD CARD

10 VOICE RECORDER FUNCTIONS

11 Bluetooth® OPERATION

12 USER SETTINGS

13 OTHERS

14 OPTIONS

INDEX

INTRODUCTION

Thank you for choosing this Icom product. This product is designed and built with Icom's state of the art technology and craftsmanship. With proper care, this product should provide you with years of trouble-free operation.

IMPORTANT

FIRST, CAREFULLY READ PRECAUTIONS AND INSTRUCTIONS that are provided with the transceiver.

SAVE THIS OPERATING GUIDE— This operating guide contains additional important operating instructions for the following transceivers.

Portable

- IC-F7010S/IC-F7020S: Simple key type transceivers
LCD + [P1] + [P2] + [OK] + [Back]
- IC-F7010T/IC-F7020T: Ten-key type transceivers
LCD + [P1] + [P2] + [OK] + [Back] + Ten-key Pad

Mobile

- IC-F7510/IC-F7520

Icom, Icom Inc. and Icom logo are registered trademarks of Icom Incorporated (Japan) in Japan, the United States, the United Kingdom, Germany, France, Spain, Russia, Australia, New Zealand, and/or other countries.

AQUAQUAKE is a trademark of Icom Incorporated.

The Bluetooth® word mark and logos are registered trademarks owned by the Bluetooth SIG, Inc. and any use of such marks by Icom Inc. is under license.

Other trademarks and trade names are those of their respective owners.

All other products or brands are registered trademarks or trademarks of their respective holders.

Icom is not responsible for the destruction, damage to, or performance of any Icom or non-Icom equipment, if the malfunction is because of:

- Force majeure, including, but not limited to, fires, earthquakes, storms, floods, lightning, other natural disasters, disturbances, riots, war, or radioactive contamination.
- The use of Icom transceivers with any equipment that is not manufactured or approved by Icom.

Section 1 ACCESSORIES

Supplied accessories.....	1-2
Attaching accessories.....	1-3
◇ Flexible antenna (Portable).....	1-3
◇ Battery pack (Portable).....	1-3
◇ Belt clip (Portable).....	1-4
◇ Connector cover (Portable).....	1-5
◇ Mounting bracket (Mobile).....	1-6

Supplied accessories

The following accessories are supplied.

NOTE: Some accessories are not supplied, or the shape is different, depending on the transceiver version.

● Portable type transceiver

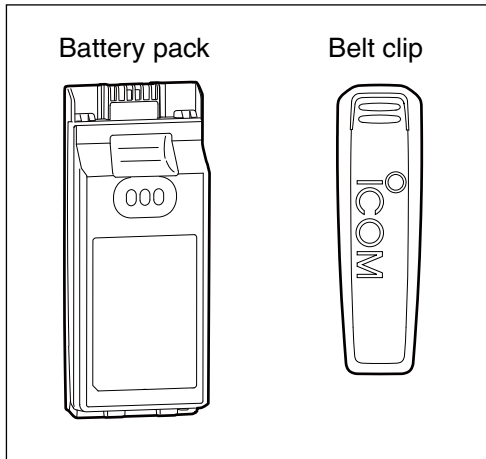

● Mobile type transceiver

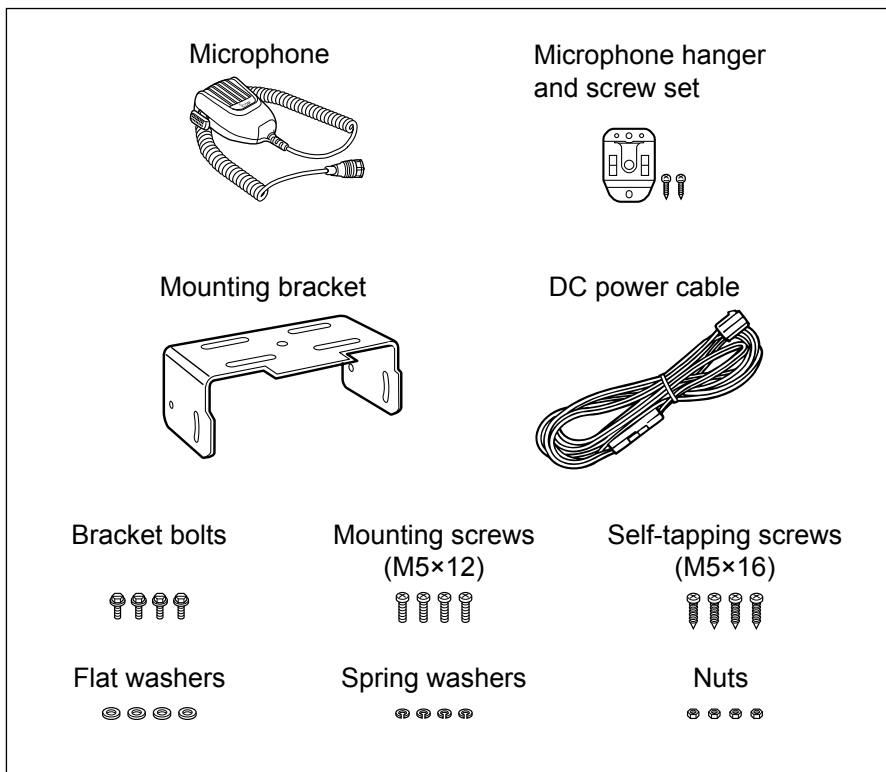

Attaching accessories

◇ Flexible antenna (Portable)

Connect the antenna to the antenna connector.

CAUTION:

- **DO NOT** carry the transceiver by holding only the antenna.
- **DO NOT** connect an antenna other than those listed in the INSTRUCTIONS.
- Transmitting without an antenna may damage the transceiver.

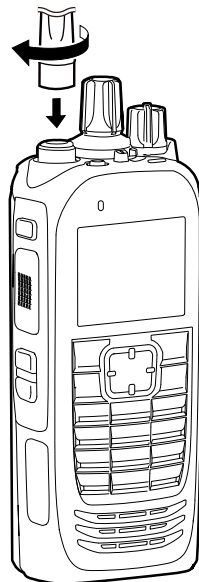

◇ Battery pack (Portable)

CAUTION: DO NOT attach or detach the battery pack when the transceiver is wet or soiled. This may result in water or dust getting into the transceiver/ battery pack and may damage the transceiver.

To attach:

1. Slide the battery pack in the direction of the arrow. **(1)**
2. Push the battery pack until the battery sliding locks make a 'click' sound. **(2)**

To detach:

1. Push both battery sliding locks in the direction of the arrow. **(1)**
 - The battery pack is then released.
2. Lift up to detach the battery pack. **(2)**

NOTE: Keep the battery pack terminals clean. It's a good idea to occasionally clean them.

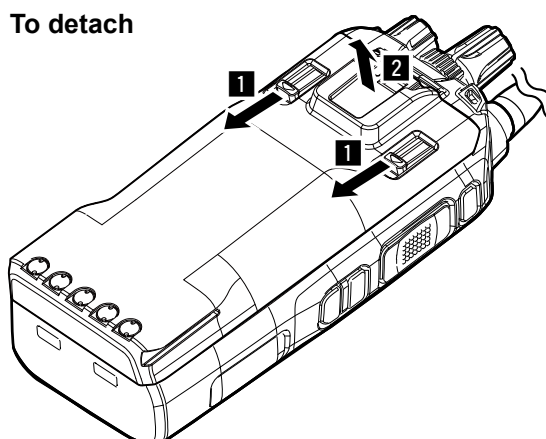
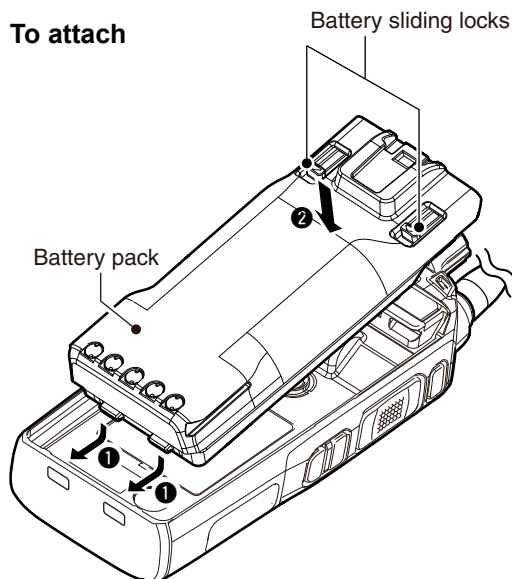

Accessory attachments (Continued)

◇ **Belt clip (Portable)**

To attach:

1. Remove the battery pack from the transceiver, if it is attached.
2. Slide the belt clip in the direction of the arrow until the belt clip is locked and makes a 'click' sound.

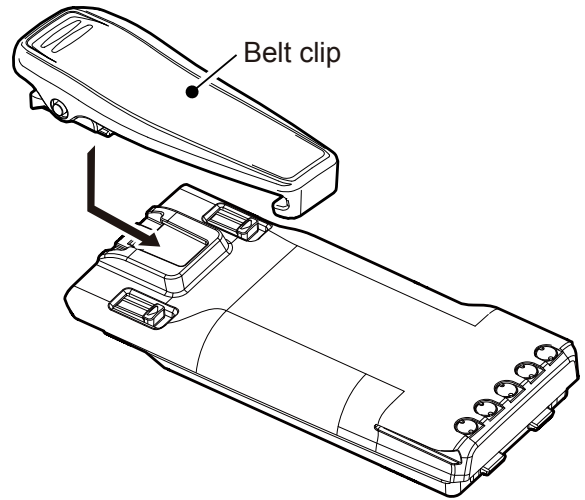

To detach:

Lift the tab up (❶), and slide the belt clip in the direction of the arrow (❷).

BE CAREFUL! DO NOT break your fingernail.

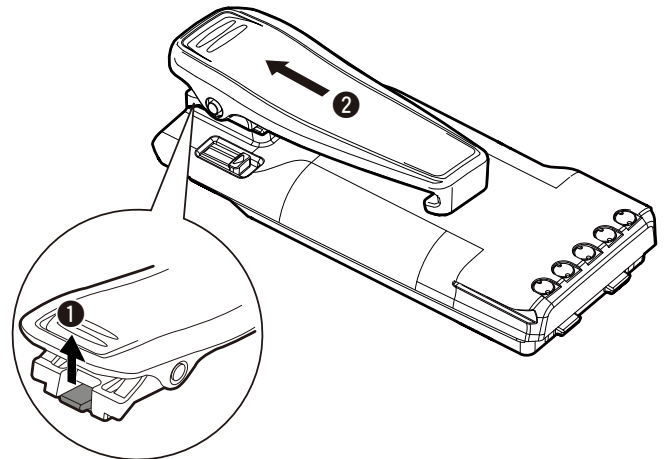

Accessory attachments (Continued)

CAUTION: DO NOT detach the connector cover when an optional equipment is not in use. Otherwise the terminals of the multi-connector may be shorted by a metal object, or become rusty by water intrusion. This could damage the transceiver.

◇ **Connector cover (Portable)**

To detach:

1. Remove the screw. (1)
2. Detach the connector cover, and then connect an optional equipment. (2)

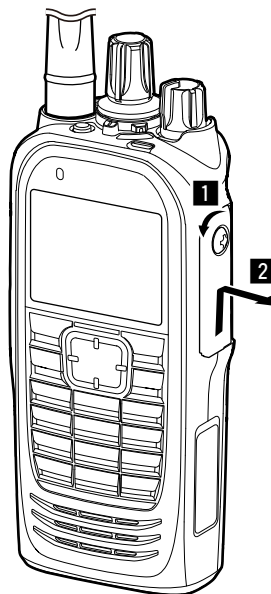

To attach:

1. Attach the connector cover over the multi-connector. (1)
2. Tighten the screw. (2)

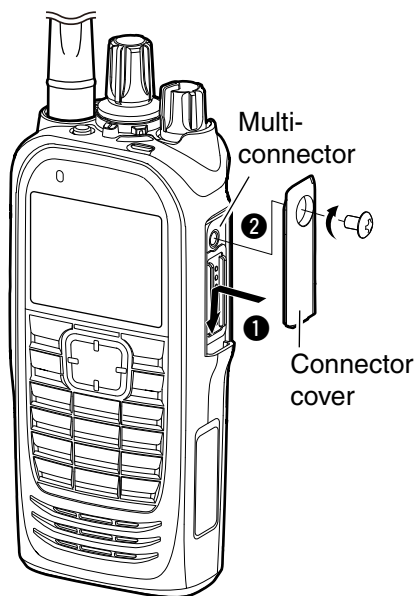

Accessory attachments (Continued)

◇ **Mounting bracket (Mobile)**

Install the mounting bracket in a place where it can be firmly attached.

① We recommend that you periodically check whether the screws are loose or not, especially after a long period of use.

CAUTION: DO NOT use bolts other than the ones that are supplied with the mounting bracket. Bolt longer than 8 mm (0.31 in) may damage the transceiver's internal units.

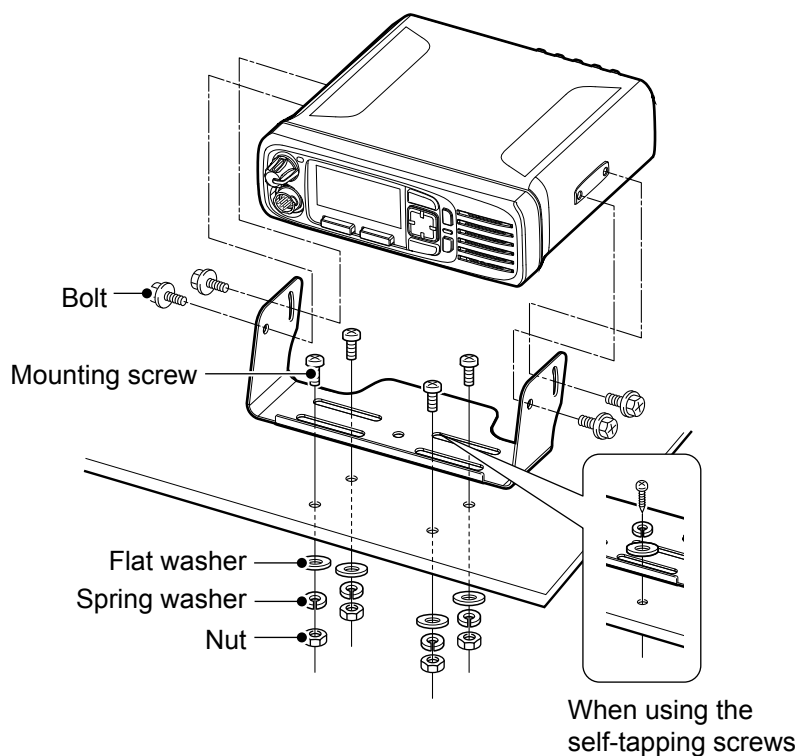

- Front, top and side panels (for the Portable type transceiver) 2-2
 - ◇ About the transceiver types 2-2
 - ◇ About the Status indicator..... 2-2
 - ◇ About the Multi-connector..... 2-2
 - ◇ About the Software key functions 2-2
- Function display (for the Portable type transceiver) 2-3
 - ◇ Icon Area..... 2-3
 - ◇ Text Area..... 2-4
 - ◇ Key Display Area 2-4
- Front, top and side panels (for the Mobile type transceiver) .. 2-5
 - ◇ About the Status indicator..... 2-5
 - ◇ About the Microphone connector..... 2-5
 - ◇ About the Software key functions 2-5
- Rear panel (for the Mobile type transceiver) 2-6
- Function display (for the Mobile type transceiver)..... 2-7
 - ◇ Icon Area..... 2-7
 - ◇ Text Area..... 2-8
 - ◇ Key Display Area 2-8
- Status indicator..... 2-9
- Assignable keys, keypads, and AB Switch2-11
 - ◇ Portable type.....2-11
 - ◇ Mobile type2-11
- Assignable Software key functions..... 2-12
 - ◇ For keys and keypads..... 2-12
 - ◇ For the AB Switch (For the Portable type transceiver)2-20

Front, top and side panels (for the Portable type transceiver)

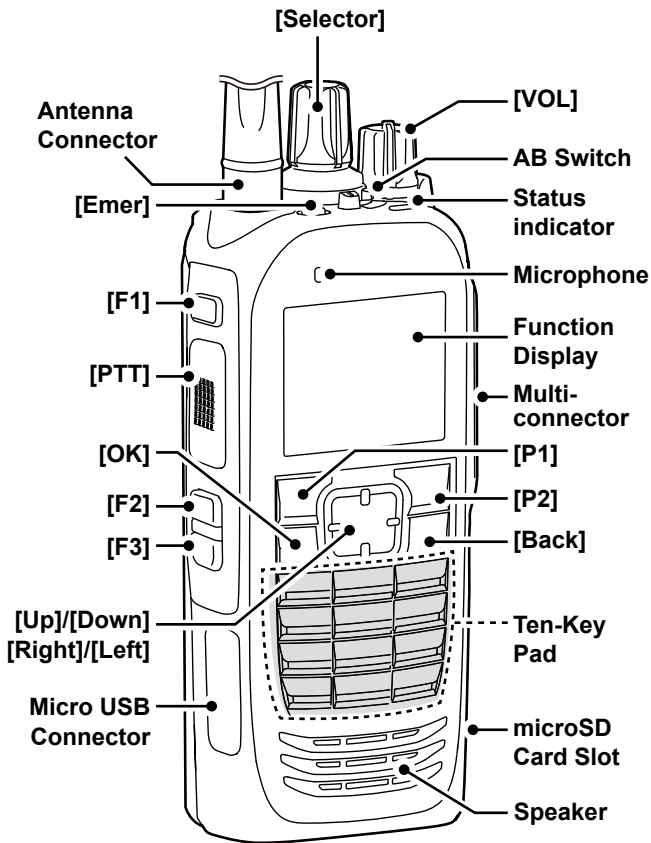

The illustration is of the Ten-key types.

◇ **About the transceiver types**

There are 2 types of transceivers.

IC-F7010S, IC-F7020S: Simple key types

IC-F7010T, IC-F7020T: Ten-key types

◇ **About the Status indicator**

- Lights white, then blinks red, yellow, and green when turning ON the transceiver.
- Lights red while transmitting.
- Lights green while receiving a signal, or when the squelch is open.
- Blinks magenta when the battery is exhausted.

◇ **About the Multi-connector**

Connects to an optional speaker microphone or headset.

CAUTION: DO NOT use the transceiver without the connector cover or optional device attached. The transceiver meets IP68 requirements for dust-tight and waterproof protection only when the connector cover or the optional device is attached.

◇ **About the Software key functions**

NOTE: Dealers can assign the Software key functions to the keys, keypads, and the AB Switch.
 ⓘ See page 2-11 for details.

Function display (for the Portable type transceiver)

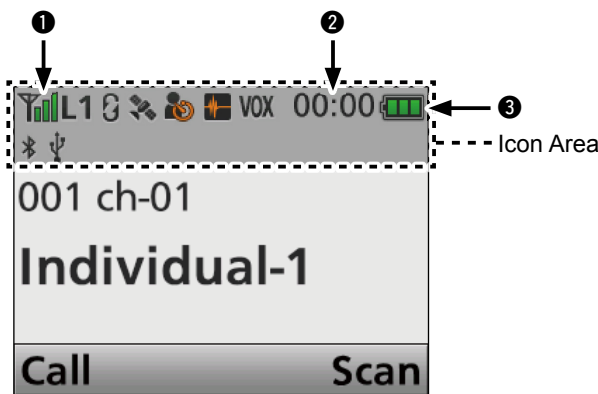

NOTE: The screen capture is an example. The displayed position of each icon may differ, depending on the function being used.

◇ Icon Area

Indicators

① SIGNAL STRENGTH INDICATOR

Displays the relative receive signal strength level.

② CLOCK

Displays the current time.

① “AM” or “PM” is displayed beside the time display when the 12 hour display format is selected.

① “--:--” is displayed instead of the current time when the internal clock is not set.

③ BATTERY INDICATOR

Displayed or blinks to indicate the battery status.

Indication				
Battery status	Full	Mid	Charging required	Battery exhausted

blinks when the battery is exhausted.

Icons

The following icons are displayed in the Icon Area.

POWER ICON

- “L1” is displayed when the output power is set to Low.
- “L2” is displayed when the output power is set to Mid.
- “H” is displayed when the output power is set to High.

AUDIBLE ICON

Displayed when the channel is in the ‘audible’ (unmute) mode.

MESSAGE ICON

- Blinks after Messages (Message or Status Message) have been received.
- Stops blinking when the screen is changed, or any key is pushed, but is displayed if unread messages are still in the Message memory.
- Disappears when all messages in the Message memory have been read.

BELL ICON

Displayed when a matching signal is received, depending on the presetting.

SCAN ICON

- Displayed when a scan is paused.
- Blinks while scanning.

SCAN TARGET CHANNEL ICON

Displayed when the channel is selected as a scan target channel.

SCRAMBLER/ENCRYPTION ICON

In the Analog mode

Displayed when the Voice Scrambler function is ON.

In the Digital mode

- Displayed when the Voice Encryption function is ON.
- Blinks when decoding an encrypted signal.

GPS ICON

- Displayed when valid position data is received.
- Blinks when searching for satellites or calculating position data.
- ① Depending on the presetting, the GPS icon is not displayed.

RECORD ICON

- Displayed when the Record function is ON.
- Blinks while recording audio.
- ① is displayed when there is no microSD card free space and audio cannot be recorded.

TALK AROUND ICON

Displayed when the Talk Around function is ON.

PHONE ICON

- Displayed when the transceiver is connected to a telephone network on the selected channel.
- Blinks while receiving a phone call.

SITE LOCK ICON

Displayed when the Site Lock function is ON.

LONE WORKER ICON

Displayed when the Lone Worker function is ON.

MOTION SENSOR ICON

Displayed when the Motion Sensor function is ON.

NOISE CANCEL ICON

Displayed when the Noise Cancel function is ON.

SURVEILLANCE ICON

Displayed when the Surveillance function is ON.

☞ Continued on the next page

Function display (for the Portable type transceiver)

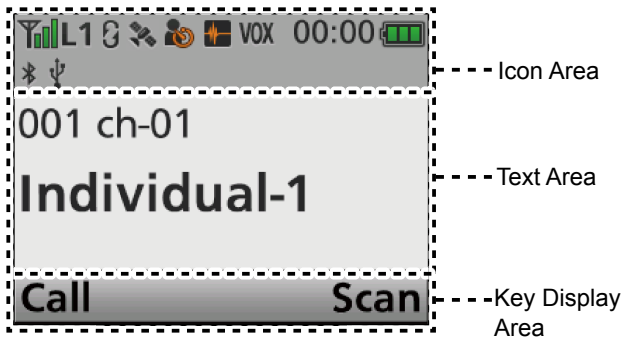

NOTE: The screen capture is an example. The displayed position of each icon may differ, depending on the function being used.

Icons (Continued)

VIBRATION ICON 



Displayed when the Vibration function is ON.

VOX ICON* 

Displayed when the VOX function is ON.

* VS-5MC, VS-3, or other Bluetooth headset is required to use the VOX function.

Bluetooth® ICON  

- "" is displayed when Bluetooth® is activated.
- "" is displayed when a Bluetooth® device is connected.

microSD ICON  

Displayed when the microSD card is inserted into the card slot.

- ①  is displayed when the microSD card has not been formatted.
- ① Depending on the presetting, the microSD icon is not displayed.

USB ICON 

Displayed when a USB device is connected.

◇ **Text Area**

Displays the selected Zone number, channel number, and, if entered, channel name.

◇ **Key Display Area**

Displays the names of the function assigned to [P1] and [P2].

Front, top and side panels (for the Mobile type transceiver)

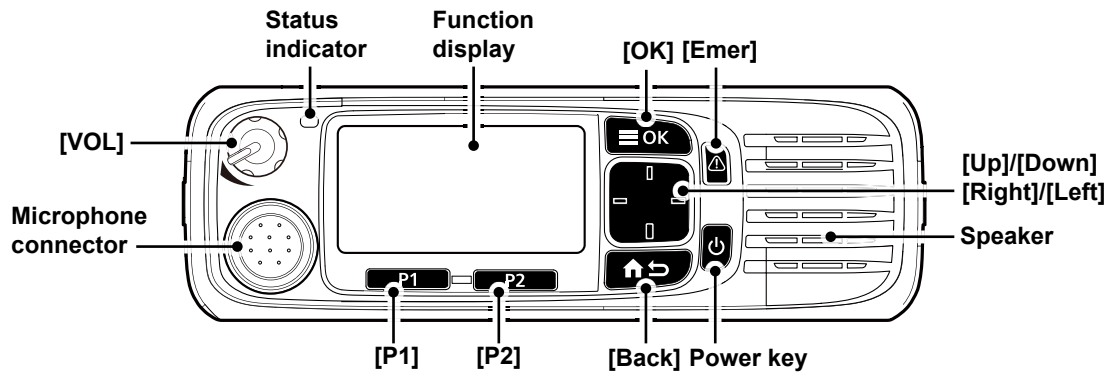

◇ **About the Status indicator**

- Lights red while transmitting.
- Lights green while receiving a signal, or when the squelch is open.

◇ **About the Microphone connector**

Connect the supplied or optional microphone.

CAUTION: DO NOT connect non-specified microphones. The pin assignments may be different and may damage the transceiver.

◇ **About the Software key functions**

NOTE: Dealers can assign the Software key functions to the keys and keypads, except for the Power key.

① See page 2-12 for details.

Rear panel (for the Mobile type transceiver)

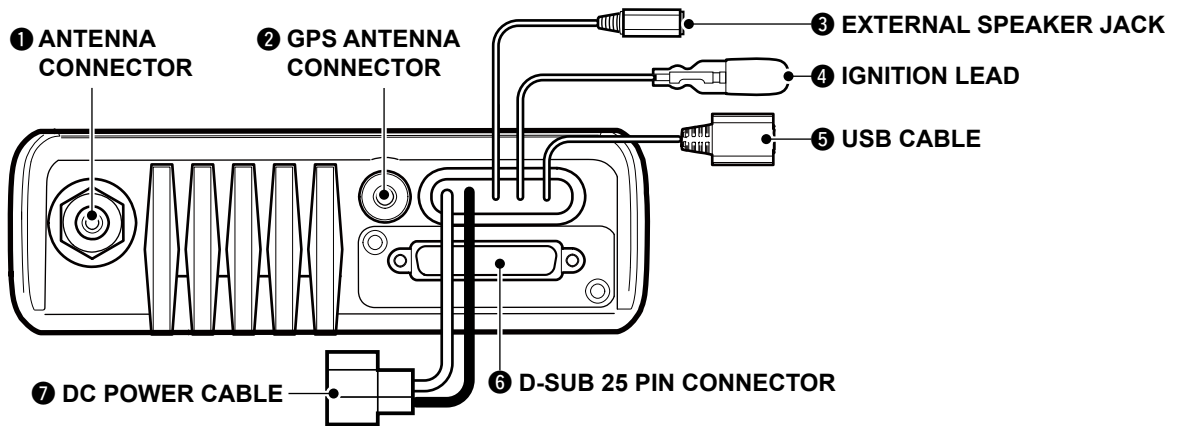

1 ANTENNA CONNECTOR

Connect to an antenna.

2 GPS ANTENNA CONNECTOR

Connect the UX-241 GPS antenna.

3 EXTERNAL SPEAKER JACK

Connect a 4 ~ 8 Ω external speaker.

4 IGNITION LEAD

Connects to a vehicle ignition line.

CAUTION: DO NOT put pressure on this lead.
Binding to the DC power cable is recommended.

5 USB CABLE

Connects to a PC.

6 D-SUB 25 PIN CONNECTOR

Connects to an external unit.

NOTE: When connecting an external unit to this connector, be sure to firmly tighten the screws.

7 DC POWER CABLE

Connects to a 12 V DC battery.
Pay attention to polarities.

CAUTION: DO NOT connect to a 24 V battery.
This will damage the transceiver.

Function display (for the Mobile type transceiver)

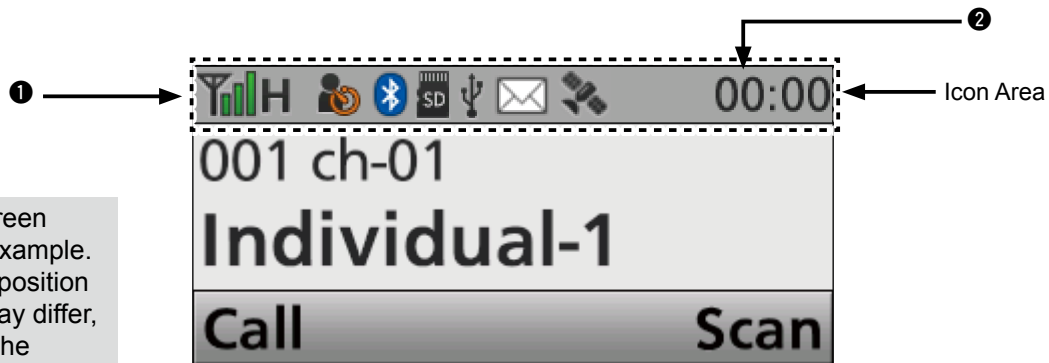

NOTE: The screen capture is an example. The displayed position of each icon may differ, depending on the function being used.

◇ Icon Area

Indicators

① SIGNAL STRENGTH INDICATOR

Displays the relative received signal strength.

② CLOCK

Displays the current time.

① “AM” or “PM” is displayed beside the time display when the 12 hour display format is selected.

① “--:--” is displayed instead of the current time when the internal clock is not set.

Icons

The following icons are displayed in the Icon Area.

POWER ICON

- “L1” is displayed when the output power is set to Low.
- “L2” is displayed when the output power is set to Mid.
- “H” is displayed when the output power is set to High.

AUDIBLE ICON

Displayed when the channel is in the ‘audible’ (unmute) mode.

MESSAGE ICON

- Blinks after Messages (Short Message or Status Message) have been received.
- Stops blinking when the screen is changed, or any key is pushed, but is displayed if unread messages are still in the Message memory.
- Disappears when all messages in the Message memory have been read.

BELL ICON

Displayed when a matching signal is received, depending on the presetting.

SCAN ICON

- Displayed when a scan is paused.
- Blinks while scanning.

SCAN TARGET CHANNEL ICON

Displayed when the channel is selected as a scan target channel.

SCRAMBLER/ENCRYPTION ICON

In the Analog mode

Displayed when the Voice Scrambler function is ON.

In the Digital mode

- Displayed when the Voice Encryption function is ON.
- Blinks when decoding an encrypted signal.

GPS ICON

- Displayed when a valid position data is received.
- Blinks when searching for satellites or calculating position data.

① Depending on the presetting, the GPS icon is not displayed.

RECORD ICON

- Displayed when the Record function is ON.
- Blinks while recording the audio.

① is displayed when there is no microSD card free space and audio cannot be recorded.

TALK AROUND ICON

Displayed when the Talk Around function is ON.

PHONE ICON

- Displayed when the transceiver is connected to a telephone network on the selected channel.
- Blinks while receiving a phone call.

SITE LOCK ICON

Displayed when the Site Lock function is ON.

LONE WORKER ICON

Displayed when the Lone Worker function is ON.

NOISE CANCEL ICON

Displayed when the Noise Cancel function is ON.

SURVEILLANCE ICON

Displayed when the Surveillance function is ON.

VOX ICON

Displayed when the VOX function is ON.

Function display (for the Mobile type transceiver)

NOTE: The screen capture is an example. The displayed position of each icon may differ, depending on the function being used.

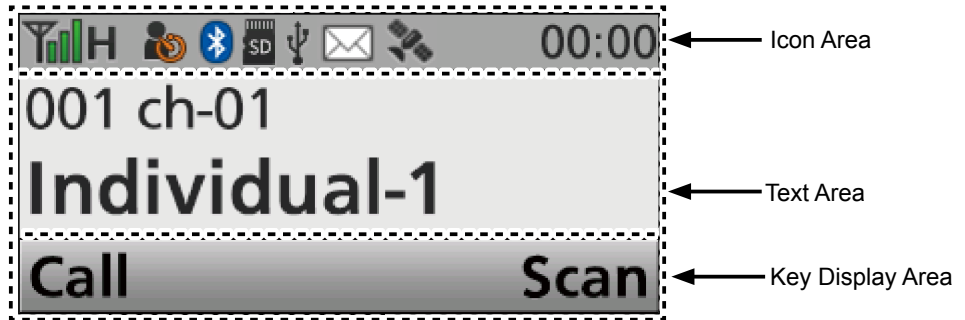

Icons (Continued)

Bluetooth® ICON  

- "Bluetooth off" is displayed when Bluetooth® is activated.
- "Bluetooth on" is displayed when a Bluetooth® device is connected.

microSD ICON  

Displayed when a microSD card is inserted.

- ① "Warning" is displayed when the microSD card has not been formatted.
- ② Depending on the presetting, the microSD icon is not displayed.

USB ICON 

Displayed when a USB device is connected.

◇ **Text Area**

Displays the selected Zone number, Channel number, and Channel name, if set.

◇ **Key Display Area**

Displays the names of the function assigned to [P1] and [P2].

Status indicator

The Status indicator indicates the status of various parameters of the transceiver, as described below.

(Reference: R=Red, G=Green, Y=Yellow, M=Magenta, W=White, B=Blue)

- Programming:
Blinks while reading or writing data.
- Programming Error:
Blinks if programming fails.
- Channel Error:
Blinks when you select a blank channel, or an unlocked channel.
- TX low Battery 1:
Blinks while detecting a low battery in the TX mode.
- TX low Battery 2:
Blinks while detecting a very low battery in the TX mode.
- TX:
Lights while transmitting.
- Bell (Blink):
Blinks about twice every second.*
- Bell (ON):
Blinks about once every second.*

*Depending on the "Bell" setting, the Status indicator blinks:

- When a call that includes a matching 2-Tone code is received.
- When a Call Alert is received.
- When a Short Message is received.
- When a Status call that includes a matching status number is received.



- Scan/Hunt:
Blinks while scanning for a channel with a signal, or while hunting for a control channel..



- RX:
Lights while receiving a signal.















- CH Access:
Blinks while making a call.



2 PANEL DESCRIPTION

Status indicator (Continued)

- Audible:
Blinks while in the Audible mode.

- Low Battery 1:
Blinks slowly when you should charge the battery soon.

- Low Battery 2:
Blinks fast when you must charge the battery.

- Power ON:
Lights white, then blinks red, yellow, and green at transceiver startup.

- Success:
Blinks slowly when your call was successful.

- Failure:
Blinks slowly when your call failed, or it was refused.

- TX Error:
Blinks when transmission is inhibited (Lockout, TX Inh, or TOT Penalty timer).

- Emergency:
Blinks while the Emergency Locator tone is sounding.

- Searching (Bluetooth®):
Blinks while searching for the Bluetooth® device.

- Waiting Paring (Bluetooth®):
Blinks while in the Waiting Pairing mode.

- Success (Bluetooth®):
Blinks when the Bluetooth® connection is successful.

- Failure (Bluetooth®):
Blinks when the Bluetooth® connection has failed.

Assignable keys, keypads, and AB Switch

◇ Portable type

Dealers can assign the Software key functions to the following keys, keypads, and the AB Switch.

Simple key type

[P1], [P2], [Up], [Down], [Left], [Right], [OK], [Back], [F1], [F2], [F3], [Emer], and the AB Switch

Ten-key type

[P1], [P2], [Up], [Down], [Left], [Right], [OK], [Back], [F1], [F2], [F3], [Emer], Keypad 0~9, *, #, and the AB Switch

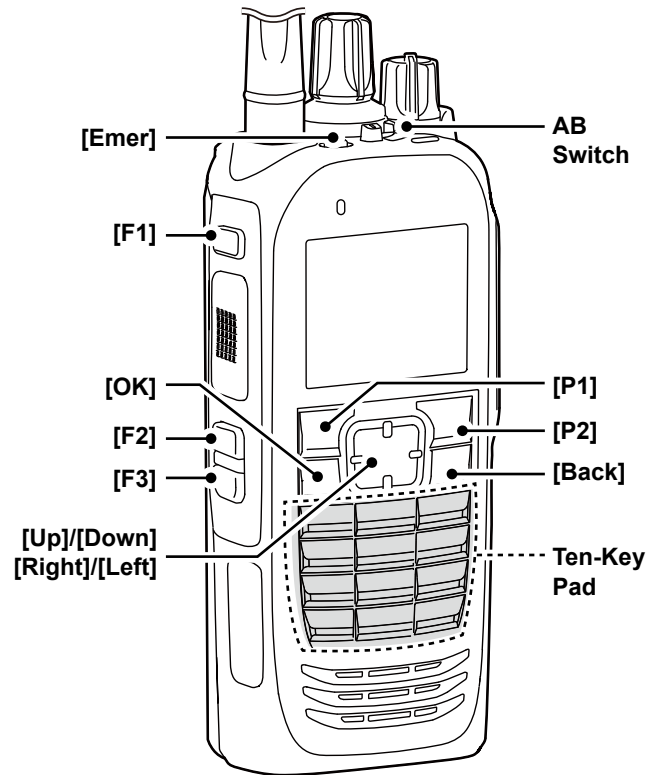

The illustration is of the Ten-key types.

◇ Mobile type

Dealers can assign the Software key functions to the following keys and keypads.

[P1], [P2], [Up], [Down], [Left], [Right], [OK], [Back], and [Emer]

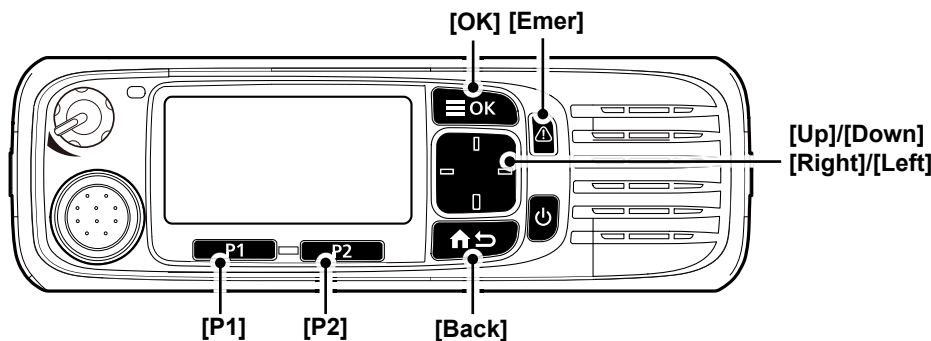

Assignable Software key functions

◇ For keys and keypads

Category	Assignable function	Digital (P25)		Analog	
		Conventional	Trunking	2-Tone	MDC
-	Disable (p. 2-14)	✓	✓	✓	✓
	Null (p. 2-14)	✓	✓	✓	✓
	Menu (p. 2-14)	✓	✓	✓	✓
	Home (p. 2-14)	✓	✓	✓	✓
Channel/ Scan (Voting)	CH Up, CH Down (p. 2-14)	✓	✓	✓	✓
	Prio A, Prio B (p. 2-14)	✓	✓	✓	✓
	Prio A (Rewrite), Prio B (Rewrite) (p. 2-14)	✓	✓	✓	✓
	Zone Up, Zone Down (p. 2-14)	✓	✓	✓	✓
	Zone Select (p. 2-14)	✓	✓	✓	✓
	Scan Start/Stop (p. 2-14)	✓	N/A	✓	✓
	Scan Add/Del (Tag) (p. 2-15)	✓	N/A	✓	✓
	Talkgroup Scan Start/Stop* ¹ (p. 2-15)	N/A	✓	N/A	N/A
	High/Low (p. 2-15)	✓	✓	✓	✓
	C.Tone CH Select (p. 2-15)	N/A	N/A	✓	✓
	Tone/NAC CH Select (p. 2-15)	✓	N/A	✓	✓
	Monitor (p. 2-15)	✓	N/A	✓	✓
	Talk Around (p. 2-15)	✓	✓	✓	✓
	Bandwidth (p. 2-15)	N/A	N/A	✓	✓
	Scrambler/Encryption* ¹ (p. 2-15)	✓	✓	✓	✓
	CKR Select* ¹ (p. 2-15)	✓	✓	N/A	N/A
Compander (p. 2-15)	N/A	N/A	✓	✓	
Signaling/ Call	Call (p. 2-16)	N/A	N/A	✓	N/A
	Re-dial (p. 2-16)	✓	✓	✓	✓
	Call Menu (p. 2-16)	✓	✓	N/A	✓
	DTMF Autodial (p. 2-16)	✓	✓	✓	✓
	Emergency (p. 2-16)	✓	✓	✓	✓
	Power OFF Emergency (p. 2-16)	✓	✓	✓	✓
	Individual (p. 2-16)	✓	✓	N/A	N/A
	Group (p. 2-16)	✓	✓	N/A	N/A
	Call Alert (p. 2-16)	✓	✓	N/A	✓
	Status (p. 2-16)	✓	✓	N/A	✓
	Message (Short Message) (p. 2-16)	✓	✓	N/A	✓

✓: Applicable
N/A: Not Applicable

➡ Continued on the next page

Depending on the transceiver's model type, some functions may not be assignable.

*¹ For only the revision 2.00 or later.

2 PANEL DESCRIPTION

Assignable Software key functions

◇ For keys and keypads (Continued)

Category	Assignable function	Digital (P25)		Analog	
		Conventional	Trunking	2-Tone	MDC
Trunking*1	Site Alias*1 (p. 2-17)	N/A	✓	N/A	N/A
	Site Lock*1 (p. 2-17)	N/A	✓	N/A	N/A
	Site Select*1 (p. 2-17)	N/A	✓	N/A	N/A
	Site Change Beep*1 (p. 2-17)	N/A	✓	N/A	N/A
	Band Scan*1 (p. 2-17)	N/A	✓	N/A	N/A
Functions	Light (p. 2-18)	✓	✓	✓	✓
	Lock (p. 2-18)	✓	✓	✓	✓
	Public Address*2 (p. 2-18)	✓	✓	✓	✓
	RX Speaker*2 (p. 2-18)	✓	✓	✓	✓
	Hook Scan*2 (p. 2-18)	✓	✓	✓	✓
	Horn*2 (p. 2-18)	✓	✓	✓	✓
	VOX (p. 2-18)	✓	✓	✓	✓
	Lone Worker (p. 2-18)	✓	✓	✓	✓
	Surveillance (p. 2-18)	✓	✓	✓	✓
	AquaQuake*3 (p. 2-18)	✓	✓	✓	✓
	Ext.CH Sel Mode (p. 2-18)	✓	✓	✓	✓
	USB Mode Select (p. 2-18)	✓	✓	✓	✓
	Keyset*1 (p. 2-19)	✓	✓	N/A	N/A
	Zeroize*1 (p. 2-19)	✓	✓	N/A	N/A
	Rekey*1 (p. 2-19)	✓	✓	N/A	N/A
GPS	GPS ON/OFF (p. 2-19)	✓	✓	✓	✓
	GPS Position (p. 2-19)	✓	✓	✓	✓
Voice Recording	Call Recorder (p. 2-19)	✓	✓	✓	✓
	Play Call Record (p. 2-19)	✓	✓	✓	✓
Audio Setting	TX Noise Cancel (p. 2-19)	✓	✓	✓	✓
	RX Noise Cancel (p. 2-19)	✓	✓	✓	✓
Bluetooth	Bluetooth (p. 2-19)	✓	✓	✓	✓
	Waiting Pairing (p. 2-19)	✓	✓	✓	✓
Vibration*3	Vibration*3 (p. 2-19)	✓	✓	✓	✓
Display	Backlight (p. 2-19)	✓	✓	✓	✓
	Brightness (p. 2-19)	✓	✓	✓	✓
	Dimmer (p. 2-19)	✓	✓	✓	✓
	LCD Mode (p. 2-20)	✓	✓	✓	✓
Control Head Setting*1,2	Intercom*1,2 (p. 2-20)	✓	✓	✓	✓

✓: Applicable

N/A: Not Applicable

Depending on the transceiver's model type, some functions may not be assignable.

*1 For only the revision 2.00 or later.

*2 For only Mobile type transceivers.

*3 For only Portable type transceivers.

Assignable Software key functions

◇ For keys and keypads (Continued)

Disable

Set to disable the key.

NOTE: This key function is assignable to only [Ext. Emer].

Null

No function.

Menu

Push to display the “Menu” screen.

① Depending on the presetting, you may be able to make various calls, select various functions and adjust the transceiver settings in the Menu screen.

① In the Menu screen, you cannot use the assigned key functions.

Home

In the Analog mode

- While in the Audible mode, push to return to the Inaudible mode.

In the Digital mode

- Push to reset the Group ID, if they have been manually changed.
- Push to cancel the Talk Back function, if it is activated.
- While in the Selection mode (Message, Status Message, and so on), hold down for 1 second to return to the Standby mode.
 - The transceiver resets the Group ID.
- While in the Trunk channel, push to reset the Site Select setting.

Category: Channel/Scan (Voting)

CH Up, CH Down

- Push to select an operating channel.
- After pushing specific keys, push to select an option, setting, and so on.

Priority A, Priority B

Push to select the Priority A or Priority B channel.

Priority A (Rewrite), Priority B (Rewrite)

- Push to select the Priority A or Priority B channel.
- Hold down for 1 second to assign the operating channel to the Priority A or Priority B channel.

Zone Up, Zone Down

Push to select an operating zone.

Zone Select

Push to display the “Zone Select” screen. Then, push [Up] or [Down] to select a zone.

TIP: What is a “zone”?

Certain channels are grouped together and assigned to a zone according to their intended use. For example, ‘Staff A’ and ‘Staff B’ are assigned to a “Business” zone, and ‘John’ and ‘Cindy’ are assigned to a “Private” zone.

Scan Start/Stop

- Push to start or cancel a Scan.
 - ① When a scan started with the Power ON Scan or Auto Scan function, pushing this key pauses the scan. The paused scan resumes after the preset time period has passed.
- Hold down for 1 second to display the “Scan List” screen. Then push [Up] or [Down] to select a list.

NOTE: When Mode Dependent Scan is ON, a user may not be able to display the Scan list, depending on the presetting.

Assignable Software key functions

◇ For keys and keypads (Continued)

Category: Channel/Scan (Voting) (Continued)

Scan Add/Del (Tag)

- Push to add a channel to, or delete it from the current Scan list.
 - When a channel is added to the current Scan list, the current Scan list text and “ON” are briefly displayed.
 - When a channel is deleted from the current Scan list, the current Scan list text and “OFF” are briefly displayed.
- You can add a channel to, or delete it from a selected Scan list.
 1. Hold down for 1 second to display the “Scan Tag” screen.
 2. Push [Up] or [Down] to select a list.
 3. Push [OK] to add a channel to, or delete it from the selected list.
 - When a channel is added to the selected Scan list, the current Scan list text and “ON” are briefly displayed.
 - When a channel is deleted from the selected Scan list, the current Scan list text and “OFF” are briefly displayed.
 4. Push [Back] to exit the “Scan Tag” screen.
- While a Scan is paused by detecting a signal on a channel (except for primary or secondary channel), push this key to remove the channel from the Scan list.

TIP: When the Nuisance Delete function is ON, the removed channel is automatically added to the Scan list again, after the Scan is canceled.

Talkgroup Scan Start/Stop

(For only the revision 2.00 or later.)

Push to start or cancel the Talkgroup scan. You can monitor the trunking group’s communication. The function scans up to 8 Talkgroup IDs and Memory channels. If the transceiver is out of range, this key is disabled.

High/Low

Push to select the transmit output power level temporarily or permanently, depending on the presetting.

C.Tone CH Select

In the Analog mode

Push to display the “C.Tone CH Select” screen. Then push [Up] or [Down] to select a tone frequency or code. After selecting, push [OK] to save.

Tone/NAC CH Select

In the Analog mode

Push to display the “C.Tone CH Select” screen. Then push [Up] or [Down] to select a tone frequency or code. After selecting, push [OK] to save.

In the Digital mode

Push to display the “NAC CH Select” screen. Then push [Up] or [Down] to select a NAC code. After selecting, push [OK] to save.

Monitor

- Push to turn the CTCSS (DTCS) or 2-Tone squelch mute ON or OFF.
 - ① Only during 2-Tone mode operation, push to open any squelch, or deactivate any mute functions. (Depending on the presetting):
 - Hold down to unmute the channel (Audible mode).
 - Push to mute the channel (Inaudible mode).

NOTE: The audible (unmute) mode may automatically return to the Inaudible (mute) mode, after the preset time period.

- Depending on the presetting, holding down this key for 1 second may cancel the Scan.

Talk Around

Push to turn the Talk Around function ON or OFF.

- ① The Talk Around function equalizes the transmit frequency to the receive frequency, for direct (Simplex) communication.

Bandwidth

In the Analog mode

Push to temporarily set the channel width to Wide* or Narrow.

*The Wide channel width cannot be used for the USA version transceivers.

Scrambler/Encryption

In the Analog mode

Push to turn the Voice Scrambler function ON or OFF.

- ① The Voice Scrambler function provides private communication between stations by using a scrambled code.

In the Digital mode (For only the revision 2.00 or later.)

Push to turn the Voice Encryption function ON or OFF.

- ① The Voice or Data Encryption function provides private communication between stations by using an Encryption Key and Key ID.

CKR Select (For only the revision 2.00 or later.)

Select the Encryption’s Common Key Reference (CKR).

Compander

In the Analog mode

Push to turn the Compander function ON or OFF.

- ① The Compander function reduces noise components on the transmit audio to provide clear communication.

Assignable Software key functions

◇ For keys and keypads (Continued)

Category: Signaling/Call

Call

In the Analog mode

Push to make a call to the preset destination in the channel.

Re-dial

Push to send the last transmitted DTMF code number.
①Redial will be cleared when the transceiver is turned OFF once.

Call Menu

1. Push to display the "Call Menu" screen.
2. Push [Up] or [Down] to select a call function.
①See 'Transmitting a call' on sections 7 and 8 for details.
3. After selecting, push [OK] to set, and display the call function screen.
4. Push [Up] or [Down] to select an ID name (or ID code).
5. After selecting, push [PTT] to make a call to the selected station or group.

DTMF Autodial

- Push to display the "DTMF Autodial" screen. Then, push [Up] or [Down] to select a DTMF code. After selecting, push [PTT] to transmit the selected DTMF code.
- While in the Standby mode, hold down for 1 second to transmit the currently selected DTMF code.

Emergency

1. Hold down during the Emer SW ON Timer period to enter the Emergency mode.
2. After the Reminder Timer period has passed, an Emergency call is automatically transmitted once, or repeatedly.

NOTE:

- Set the related settings using the programming software.
- This key function is assignable to only [Emer] or [Ext. Emer].

①Hold down during the Emer SW OFF Timer period to cancel the Emergency function, before transmitting an Emergency call.

Power OFF Emergency

(For the Mobile type transceivers)

While holding down this key, turn OFF the transceiver to activate the Power OFF Emergency function.

NOTE: This key function is assignable to only [Emer] or [Ext. Emer].

①Information

- This function makes the transceiver transmit Emergency calls, even though it appears to be powered OFF.
- When the function is activated, any key operation, hanger action and Lone Worker function becomes invalid, as well as the Status indicator and speaker become the same as being powered OFF. On the other hand, the transceiver can transmit Emergency calls according to the Emergency settings, and the Ambience Listening function is also activated, if it is set.
- To cancel the function and restore the transceiver, turn ON the transceiver.

Individual

In the Digital mode

Push to display the "Individual ID" screen. Then, push [Up] or [Down] to select an Individual ID name (or ID code).

After selecting, push [OK] to set.

Group

In the Digital mode

Push to display the "Group ID" screen. Then, push [Up] or [Down] to select an Group ID name (or ID code).

After selecting, push [OK] to set.

Call Alert

Hold down for 1 second to transmit a Call Alert.

Status

Push to display the "Status List" screen. Then, push [Up] or [Down] to select a Status message.

①See pages 7-6, 8-14 for details.

Message (Short Message)

While in the Standby mode, push to display the "Message List" screen. Then, push [Up] or [Down] to select a message.

①See pages 7-3, 8-4 for details.

Assignable Software key functions

◇ For keys and keypads (Continued)

Category: Trunking **(For only the revision 2.00 or later.)**

Site Alias

Push to display the RFSS ID and Site ID, or the Site Alias name if entered.

Site Lock

Locks the transceiver in the current registered site. This function inhibits the transceiver from roaming other sites.

Site Select

Edit the RFSS ID or connect to the site.

Editing the RFSS ID:

1. Push to display the current site name.
2. While displaying the site, push [OK] to display its RFSS ID and the Site ID.
3. Hold down [OK] to enter the editing mode.
4. Push [Up] or [Down] to set.

Connecting to the site:

1. Push to display the current site name.
2. Hold down [OK] to connect to the site.
3. While displaying the site, hold down [OK] to connect to the site.

Site Change Beep

Select whether or not to sound a beep after registration and group affiliation are successful in the Trunking system.

Band Scan

Push to start and cancel the Band Scan.

① You cannot use this key while scanning, transmitting, or in the Conventional mode.

Assignable Software key functions

◇ For keys and keypads

Category: Functions

Light

Push to turn ON the backlight for about 5 seconds, even if the backlight setting is OFF.

Lock

Hold down for 1 second to turn the Key Lock function ON or OFF.

① All assignable keys except the following are electronically locked: [Monitor], [Light], [Lock], [Call], [Emergency], [Surveillance] and [Lone worker]. Also, [PTT] and [Power] are usable.

Public Address (For the Mobile type transceivers)

Push to activate the Public Address (PA) function. And then, speak into the microphone while holding down [PTT].

① When the PA function is activated, the audio output can be separately controlled from the transceiver by pushing [Up] or [Down].

NOTE: This function is usable when an external unit, such as a audio amplifier, speaker, and so on is connected to the D-Sub 25 pin connector.

RX Speaker (For the Mobile type transceivers)

Push to turn the RX Speaker function ON or OFF.

① When the RX Speaker function is turned ON, the received audio can be heard through an external speaker that is connected to the D-Sub 25 pin connector.

NOTE:

- This function is usable when an external speaker is connected to the D-Sub 25 pin connector.
- This function is useful when a user is out of the vehicle.
- The audio output level is linked to the transceiver's volume control.

Hook Scan (For the Mobile type transceivers)

Push to temporarily turn the Hook Scan function ON or OFF.

Horn (For the Mobile type transceivers)

Push to turn the Horn function ON or OFF.

① When the Horn function is ON, the HORN terminal of the D-Sub 25 pin or Option Connector 22 pin is activated after receiving a call*.

*Only a call that the Dec EXO or RX EXO setting is ON.

① This function is useful when a user is away from the transceiver.

NOTE: This function is usable when an external speaker is connected to the D-Sub 25 pin connector.

VOX

Push to turn the VOX function ON or OFF.

① The function automatically switches between receive and transmit by detecting your voice.

NOTE: To use the function, a headset* and a VOX converter cable are required (user supplied).

*Bluetooth headset is also usable.

Lone Worker

Push to turn the Lone Worker function ON or OFF.

① If no operation occurs during the specified period, the Lone Worker function automatically makes the transceiver enter the Emergency mode.

NOTE: To use the Lone Worker function, set the related settings using the programming software.

Surveillance

Push to turn the Surveillance function ON or OFF.

① When this function is turned ON, the beep is not heard and the backlight and the Status indicator do not light, even when a signal is received, or a key is pushed.

AquaQuake (For the Portable type transceivers)

While holding down this key, the AquaQuake water draining function removes water from the speaker grill by vibrating the internal speaker.

- Water in the speaker grill may muffle the sound coming from the speaker.

NOTE:

- After the specified period of time, this function automatically stops, even if a user continues to hold down this key.
- This key works with only the internal speaker.

Ext.CH Sel Mode

Push to turn the Ext. CH Select function ON or OFF.

① When this function is ON, Memory channels are selected by only external entry.

NOTE:

- This function is activated when an external unit is connected to the transceiver.
- To use the function, set the input port function to "MCH Select:1" to "MCH Select: 5" to any pins, using the programming software.

USB Mode Select

Push to set the USB port mode to "Card Reader" or "Data Transfer."

Assignable Software key functions

◇ For keys and keypads (Continued)

Keypad (For only the revision 2.00 or later.)

In the Digital mode

Push to enter the keypad selection mode.

Zeroize (For only the revision 2.00 or later.)

In the Digital mode

Hold down for 1 second to zeroize the encryption key data that is programmed by the key loader.

Rekey (For only the revision 2.00 or later.)

In the Digital mode

Hold down for 1 second to transmit a Key Management Message (KMM-Hello command) to a Key Management Facility (KMF) to request rekeying.

Category: GPS

GPS ON/OFF

Push to turn the GPS function ON or OFF.

①When this function is ON, the Latitude, Longitude, and Altitude data is displayed in the "My Position" screen.

NOTE: If the internal GPS receiver does not receive position data, no position data is displayed.

GPS Position

Push to display the "GPS Position" screen in the Menu mode.

①See page 6-12 for details.

Category: Voice Recording

Call Recorder

Push to start or stop the voice recording.

NOTE: This key is usable only when a microSD card is inserted into the transceiver's card slot.

Play Call Record

Push to display the "Play Call Rec" screen.

①The screen displays the folders that contain recorded audio files.

①See page 10-4 for details.

NOTE: This key is usable only when a microSD card is inserted into the transceiver's card slot.

Category: Audio Setting

TX Noise Cancel

Push to select the TX Noise Cancel level between 1 and 3 to suppress the microphone input noise to make the audio easy to hear.

①When "OFF" is selected, the microphone input noise is not suppressed.

RX Noise Cancel

Push to select the RX Noise Cancel level between 1 and 3 to suppress the receive audio noise to make the audio easy to hear.

①When "OFF" is selected, the receive audio noise is not suppressed.

Category: Bluetooth

Bluetooth

Push to turn the Bluetooth® function ON or OFF.

Waiting Pairing

Push to enter the Pairing Request Wait mode.

• The transceiver waits for a pairing request from a Bluetooth® device.

Category: Vibration

Vibration (For the Portable type transceivers)

Push to turn the Vibration function ON or OFF.

①When "ON" is selected, the transceiver vibrates when a matching call or ID is received.

Category: Display

Backlight

Push to select the Backlight level.

(For the Portable type transceivers)

- OFF: The backlight is always OFF.
- ON: The backlight is always ON.
- Auto: When any switch except [PTT] is pushed, the backlight lights for 5 seconds.

(For the Mobile type transceivers)

- OFF: The backlight is continuously OFF.
- ON: Turns the backlight is continuously ON.
- Auto: Turns the backlight continuously ON with the Brightness setting level.
When the Dimmer terminal of the D-Sub 25 pin or Option Connector 22 pin is activated, the backlight lights dimly.

Brightness

Push to open the "Brightness" window. Then, push [Up] or [Down] to select the desired level between 0 (the lowest) and 7 (the highest).

Dimmer

Push to open the "Dimmer" window. Then, push [Up] or [Down] to select the desired level between 0 (the lowest) and 7 (the highest).

NOTE: It is recommended to be the Dimmer level lower than the Brightness level.

Assignable Software key functions (Continued)

LCD Mode

Push to select the LCD Mode.

- Day : The LCD is set to the Day mode.
The Day mode is for the daytime operation, and the display backlight color is set to white.
- Night : The LCD is set to the Night mode.
The Night mode is for the nighttime operation, and the display backlight color is set to black.

**Category: Control Head Setting
(For only the revision 2.00 or later Moblie type transceivers)**

Intercom

Push to turn the Intercom function ON or OFF.
This function enables the user to communicate between the optional control heads.

**◇ For the AB Switch
(For the Portable type transceiver)**

Functions can be assigned to the AB Switch.

NOTE: The function that is assigned to the AB Switch, cannot be assigned to any key.

Transceiver's top view

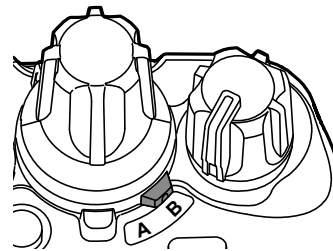

Assignable function	Digital (P25)		Analog	
	Conventional	Trunking	2-Tone	MDC
Null (p. 2-21)	✓	✓	✓	✓
Zone (p. 2-21)	✓	✓	✓	✓
Prio-A (p. 2-21)	✓	✓	✓	✓
Prio-B (p. 2-21)	✓	✓	✓	✓
Lock (p. 2-21)	✓	✓	✓	✓
Lone Worker (p. 2-21)	✓	✓	✓	✓
High/Low (p. 2-21)	✓	✓	✓	✓
Talk Around (p. 2-21)	✓	✓	✓	✓
Surveillance (p. 2-21)	✓	✓	✓	✓
Scrambler/Encryption (p. 2-21)	✓	✓	✓	✓
Compander (p. 2-21)	N/A	N/A	✓	✓
Site Lock (p. 2-21)	N/A	✓	N/A	N/A

✓: Applicable
N/A: Not Applicable

Assignable Software key functions

◇ For the AB Switch (For the Portable type transceiver) (Continued)

Null

No function.

Zone

Rotate to select a zone.

Prio-A/Prio-B

Rotate to select the Priority A or Priority B channel.

Lock

Rotate to turn the key lock function ON.

Lone Worker

Turns the Lone Worker function ON or OFF.

① If no operation occurs during the specified period, the Lone Worker function automatically makes the transceiver enter the emergency mode.

NOTE: To use the Lone Worker function, set the related settings using the programming software.

High/Low

Rotate to switch the transmit output power to “Low1” from the independent settings for each channel.

Talk Around

Rotate to turn the Talk Around function ON.

① The Talk Around function equalizes the transmit frequency to the receive frequency for transceiver-to-transceiver communication.

Surveillance

Rotate to turn the Surveillance function ON.

① When this function is turned ON, the beep is not heard and the backlight and the Status indicator do not light, even when a signal is received, or a key is pushed.

Scrambler/Encryption

In the Analog mode

Rotate to turn the Voice Scrambler function ON.

① The Voice Scrambler function provides private communication between stations.

In the Digital mode (For only the revision 2.00 or later.)

Push to turn the Voice Encryption function ON or OFF

① The Voice or Data Encryption function provides private communication between stations by using an Encryption Key and Key ID.

Compander

In the Analog mode

Rotate to turn the Compander function ON.

Site Lock

Locks the transceiver in the current registered site. This function inhibits the transceiver from roaming other sites.

Section 3

BASIC OPERATION

Turning ON the transceiver	3-2
◇ Adjusting the audio level.....	3-2
◇ Entering the password	3-2
Selecting a Zone.....	3-3
◇ Selecting a Zone	3-3
Selecting a channel	3-4
◇ Selecting an operating channel.	3-4
◇ Selecting the Priority A or B channel.....	3-4
◇ Rewriting the Priority A or B channel	3-5
◇ Selecting a Continuous tone channel	3-5
◇ Selecting a NAC channel.....	3-6
Call procedure	3-7
Receiving and transmitting	3-8
◇ Transmitting notes	3-8
Key Lock function	3-9

Turning ON the transceiver

NOTE: Before using the transceiver for the first time, the battery pack must be fully charged for optimum life and operation. See the INSTRUCTIONS for details.

Portable:

Rotate [VOL] to turn ON the transceiver.
 • The battery voltage or the opening text may be displayed, depending on the presetting.

Mobile:

Push the Power key to turn ON the transceiver.
 • The opening text may be displayed, depending on the presetting.

◇ **Adjusting the audio level**

When receiving a call, rotate [VOL] to adjust the audio output level to a comfortable listening level.

◇ **Entering the password**

1. If the transceiver is preset for a Power ON password when turning ON the transceiver, the “User Password” screen is displayed, as shown to the right.
2. Push [Up], [Down], [Right], or [Left] to select a number, then push [OK] to enter.
3. Repeat step 2 to enter the password.
4. After entering the correct password, the transceiver automatically displays the standby screen.

NOTE: If the transceiver does not display the standby screen after entering the password, the entered code may be incorrect. In this case, push [Back] several times until you delete the incorrect code, and then enter the correct code.

TIP: For the Portable Ten-key type transceiver or optional HM-220T/HM-221T, a user can enter the password with the keypad.

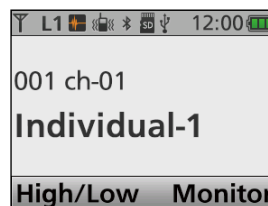
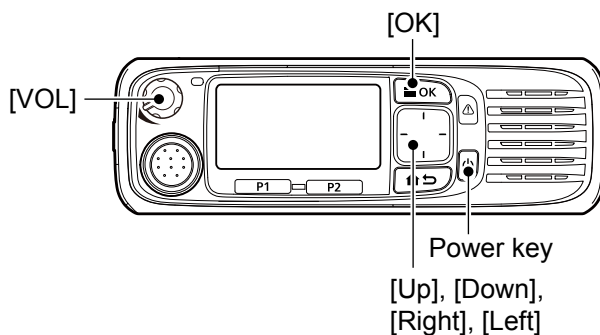
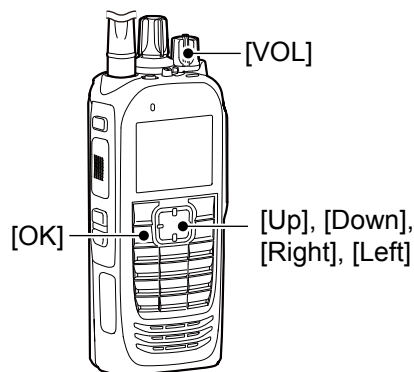

Standby screen

Selecting a Zone

◇ Selecting a Zone

Select a Zone type from Conventional or Voting.

TIP: What is a “Zone”?

Certain channels are grouped together and assigned to a Zone according to their intended use. For example, ‘Staff A’ and ‘Staff B’ are assigned to a “Business” Zone, and ‘John’ and ‘Cindy’ are assigned to a “Private” Zone.

<Key or Selector operation>

Portable: For all types

Mobile: For all types

- Rotate [Selector]*. (Only the Portable type)
*When “Zone” is assigned.
- Push [Zone Up] or [Zone Down].
- Push [Zone Select] to display the “Zone Select” screen. Then, push [Up] or [Down] to select a Zone. After selecting, push [OK].

<Menu operation>

(Menu > Channel/Scan > **Zone Select**)

1. Push [Menu] to display the Menu screen.
2. Push [Left] or [Right] to select “Channel/Scan,” then push [OK].
3. Push [Up] or [Down] to select “Zone Select,” then push [OK].
• Displays the “Zone Select” screen.

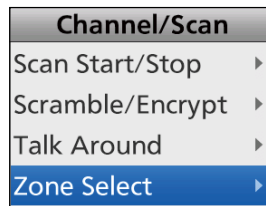

4. Push [Up] or [Down] to select a Zone, then push [OK].

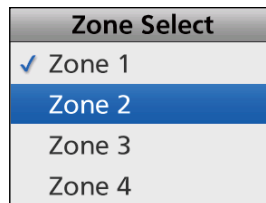

5. The selected Zone is displayed.

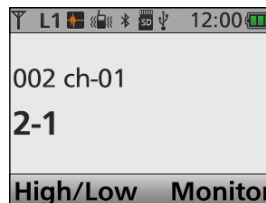

Selecting a channel

◇ Selecting an operating channel

<Key or Selector operation>

- Rotate [Selector]. (Only the Portable type)
- Push [CH Up] or [CH Down].

<Ten-key operation>

Portable: For the Ten-key type

Mobile: For the optional HM-220T or HM-221T HAND MICROPHONE

- Push the keypad to directly enter a channel number, depending on the presetting.

Example: Selecting Channel 2

Push [0] → [0] → [2 ABC].

<Voting operation>

The transceiver automatically starts scanning when a Zone specified for the Voting operation is selected.

The Voting scan detects the signal strength of the repeaters, and automatically selects the strongest one.

<Automatic Scan operation>

Depending on the presetting, when the user turns ON the transceiver, a scan automatically starts. The scan stops when a call is received.

◇ Selecting the Priority A or B channel

<Key operation>

Push [Prio-A] or [Prio-B] to select the Priority A or Priority B channel.

<Menu operation>

(Menu > Channel/Scan > **Priority A CH**)

(Menu > Channel/Scan > **Priority B CH**)

1. Push [Menu] to display the "Menu" screen.
2. Push [Left] or [Right] to select "Channel/Scan," then push [OK].

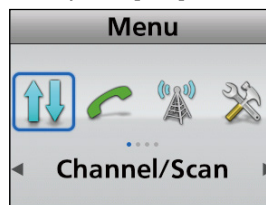

3. Push [Up] or [Down] to select "Priority A CH" or "Priority B CH," then push [OK].

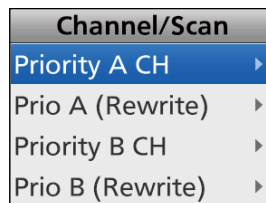

(Example: Priority A CH)

4. Hold down [Back] for 1 second to return to the standby screen.

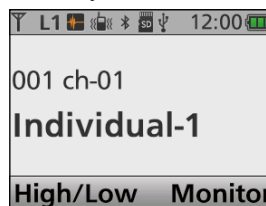

Selecting a channel (Continued)

◇ **Rewriting the Priority A or B channel**
 <Key operation>

1. Select a channel to be set as the Priority A or B channel. (p. 3-4)
2. Hold down [Prio A (Rewrite)] or [Prio B (Rewrite)] for 1 second.
 - Sets the selected channel as the Priority A or B channel.

<Menu operation>

(Menu > Channel/Scan > **Prio A (Rewrite)**)

(Menu > Channel/Scan > **Prio B (Rewrite)**)

1. Select a desired channel to be set as the Priority A or B channel. (p. 3-4)
2. Push [Menu] to display the "Menu" screen.
3. Push [Left] or [Right] to select "Channel/Scan," then push [OK].

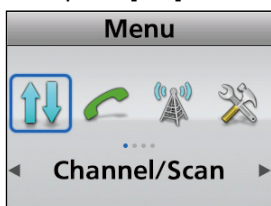

4. Push [Up] or [Down] to select "Prio A (Rewrite)" or "Prio B (Rewrite)."

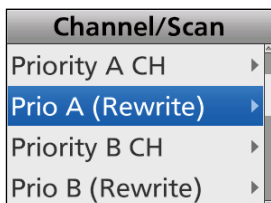

5. Push [OK].
 - Sets the selected channel as the Priority A or B channel.

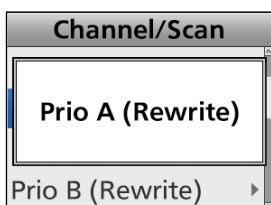

◇ **Selecting a Continuous tone channel**
 <Key operation>

1. While in the Analog mode, push [C.Tone CH Select] to display the "C.Tone CH Select" screen.
2. Push [Up] or [Down] to select a Continuous tone channel, then push [OK].
 - Sets the selected channel.

<Menu operation>

(Menu > Channel/Scan > **C.Tone CH Select**)

1. While in the Analog mode, push [Menu] to display the "Menu" screen.
2. Push [Left] or [Right] to select "Channel/Scan," then push [OK].

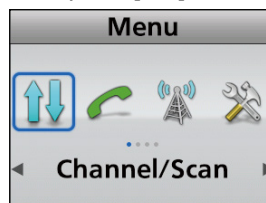

3. Push [Up] or [Down] to select "C.Tone CH Select," then push [OK].
 - Displays the "C.Tone CH Select" screen.

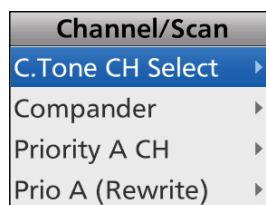

4. Push [Up] or [Down] to select a Continuous tone channel, then push [OK].
 - Sets the selected channel.

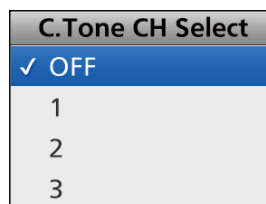

5. Hold down [Back] for 1 second to return to the standby screen.
 - The selected Continuous tone channel number is displayed.

Selecting a channel (Continued)

◇ **Selecting an NAC channel**

<Key operation>

1. While in the Digital mode, push [Tone/NAC CH Select] to display the “NAC CH Select” screen.
2. Push [Up] or [Down] to select an NAC channel, then push [OK].
 - Sets the selected channel.

<Menu operation>

(Menu > Channel/Scan > **NAC CH Select**)

1. While in the Digital mode, push [Menu] to display the “Menu” screen.
2. Push [Left] or [Right] to select “Channel/Scan,” then push [OK].



3. Push [Up] or [Down] to select “NAC CH Select,” then push [OK].
 - Displays the “NAC CH Select” screen.

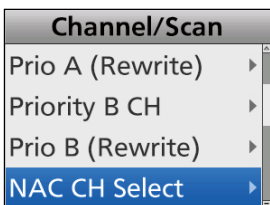

4. Push [Up] or [Down] to select an NAC channel, then push [OK].
 - Sets the selected channel.

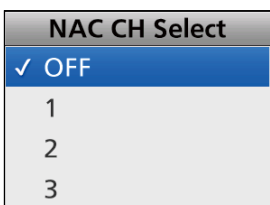

5. Hold down [Back] for 1 second to return to the standby screen.
 - The selected NAC channel number is displayed.

Call procedure

When your system uses tone signaling (except CTCSS and DTCS), a call procedure may be necessary prior to voice transmission. The tone signaling employed may be a selective calling system, which enables you to call only specific stations, and prevents unwanted stations from contacting you.

1. Select a channel according to your system operator's instructions.
 - This may not be necessary, depending on the presetting.
 - Refer to page 3-4 for details.
2. Push [Call].
3. After transmitting, the remainder of your communication can be carried out in the normal way.

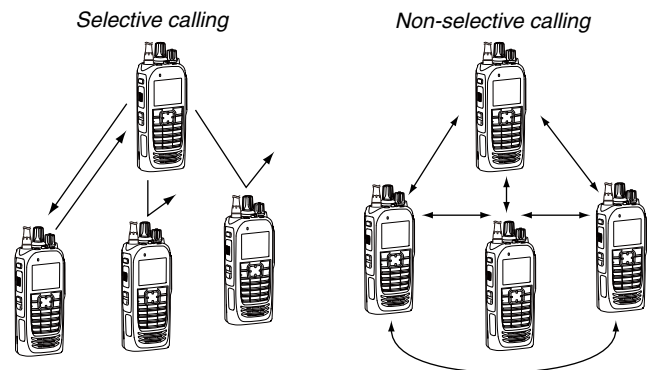

The illustration is of the Ten-key type transceivers.

Receiving and transmitting

CAUTION: DO NOT transmit without an antenna. It may damage the transceiver. See pages 1-3 and 2-6 for accessory attachments.

Receiving:

1. Turn ON the transceiver. (p. 3-2)
2. Select a channel. (p. 3-4)
3. When receiving a call, rotate [VOL] to adjust the audio output level to a comfortable listening level.

NOTE: Depending on the presetting, the transceiver may automatically transmit the microphone audio for the preset time period when a matching signal is received. (Auto TX function)

Transmitting:

Wait for the channel to become clear to avoid interference.

1. While holding down [PTT], speak at your normal voice level.
 - To transmit a tone frequency (2-Tone) push [Call].
2. Release [PTT] to return to receive.

IMPORTANT: To maximize the readability of your signal.

1. Pause briefly after pushing [PTT].
2. Hold the microphone 5 to 10 cm (2 to 4 inches) from your mouth, then speak at your normal voice level.

◇ Transmitting notes

Transmit inhibit function

The transceiver has several inhibit functions which restrict transmission under the following conditions:

- The channel is in the Inaudible mode ("◀": Audible icon does not appear.)
- The channel is busy. However, depending on the presetting, you can transmit when a call is received that includes a non-matching (or matching) CTCSS (DTCS), NAC (Network Access Code), Individual ID, or Group ID.
- The selected channel is a 'receive only' channel.

Time-Out timer

If continuous transmission exceeds the preset Time-Out Timer time, the transmission is cut off.

Penalty timer

After the transmission is cut off by the Time-Out Timer, transmission is further inhibited for a preset penalty period of timer.

Key Lock function

You can use the Key Lock function to prevent accidental channel changes and unnecessary function access.

① All assignable keys except the following are electronically locked: [Monitor], [Light], [Lock], [Call], [Emergency], [Surveillance] and [Lone Worker]. Also, [PTT] and [Power] are usable.

<Key operation>

Hold down for 1 second to turn the Key Lock function ON or OFF.

NOTE: The Key Lock function can be assigned to any key, only when it is NOT assigned to the AB switch.

<AB switch operation>

① The AB switch can be used only when the Key Lock function is assigned.

- Slide the AB switch to the "A" or "B" position that the Key Lock function is assigned to turn ON the Key Lock function.
- Slide the AB switch to the "A" or "B" position that the Key Lock function is not assigned to turn OFF the Key Lock function.

Section 4 **ADVANCED OPERATION**

DTMF calls	4-2
◇ Manual Dialing	4-2
◇ Autodial	4-2
Emergency call	4-3
◇ Transmitting an Emergency call.....	4-3
Scrambler	4-7
Network Access Code (NAC)	4-7
AquaQuake™ Water Draining function (for the Portable type transceiver)	4-8

DTMF calls

◇ Manual Dialing

A user can send DTMF codes.

While holding down [PTT], push the keys on the Ten-key pad.

◇ Autodial

A user can quickly send DTMF tones that have been pre-entered into the transceiver.

1. Push [DTMF Autodial] to display the “DTMF Autodial” screen.

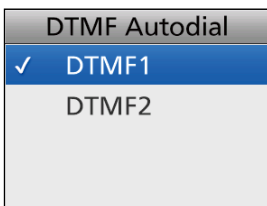

2. Push [Up] or [Down] to select a DTMF Memory.

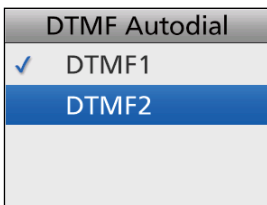

3. Push [PTT] to send the selected DTMF Memory's codes.
 - After sending, automatically returns to the standby screen.

TIP: In the standby screen, a user can send the currently selected DTMF Memory's codes by holding down [Autodial].

Emergency call

IMPORTANT: It is recommended that the dealer sets an Emergency channel in each zone, to provide a reliable Emergency call operation.

NOTE: Depending on the presetting, the following functions may be automatically activated.

Auto TX function

After an Emergency call transmission, the transceiver transmits the microphone audio for a preset period of time.

Auto RX function

After an Emergency call transmission, the transceiver stands by in the Audible mode for a preset period of time.

TIP: A user can transmit the Emergency call in the 2-Tone, APCO P25, or MDC 1200 signaling system.

◇ **Transmitting an Emergency call**

When the transceiver enters the Emergency mode, a countdown starts. The transceiver counts down during the Reminder Timer set time.

Before the Reminder Timer set time expires, the transceiver transmits an Emergency call once, or repeatedly*, on the specified Emergency channel. If no Emergency channel is specified, the Emergency call is made on the previously selected channel.

* Depending on the presetting.

- ① The transceiver automatically transmits a repeat Emergency call until the [Back] key is pushed, it receives an acknowledgement, or until a user turns OFF the transceiver.
- ① If the transceiver is set for Silent operation, it transmits an Emergency call without a beep sounding or the status indicator lighting.

The transceiver enters the Emergency mode through the following functions:

• **The [Emergency] key**

When a user holds down [Emergency] for the Emer SW ON Timer preset time.

- ① If a user holds down [Emergency] for the Emer SW OFF Timer set time before the Reminder Timer set time expires, the Emergency mode is canceled.

(Example)

- Emer SW ON Timer: 10 seconds
- Reminder Timer: 10 seconds

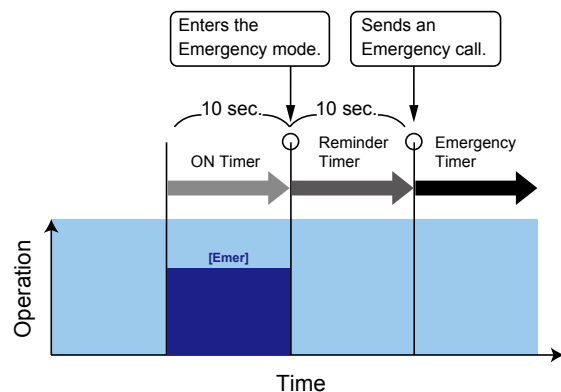

Emergency call

◇ Transmitting an Emergency call (Continued)
 The transceiver enters the Emergency mode through the following functions:

• **The Man Down function**

When the transceiver leans past the preset angle for the ON Timer preset time.

- ① If a user raises the transceiver back from the preset angle towards the vertical position before the Reminder Timer set time expires, the Emergency mode is canceled.

(Example)

- ON Timer: 10 seconds
- Reminder Timer: 10 seconds
- Angle: 45 degrees

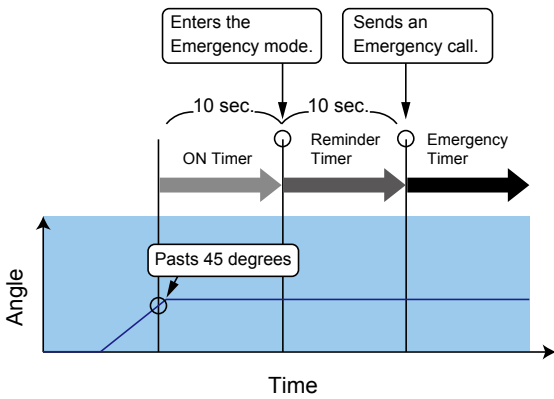

With Stationary

- The transceiver leans past the preset angle for the ON Timer preset time.
- AND
- The transceiver is detected as stationary (no motion) for the ON Timer set time.

- ① If a user raises the transceiver back from the preset angle towards the vertical position, or when the user moves the transceiver before the Reminder Timer set time expires, the Emergency mode is canceled.

(Example)

- ON Timer: 10 seconds
- Reminder Timer: 10 seconds
- Angle: 45 degrees

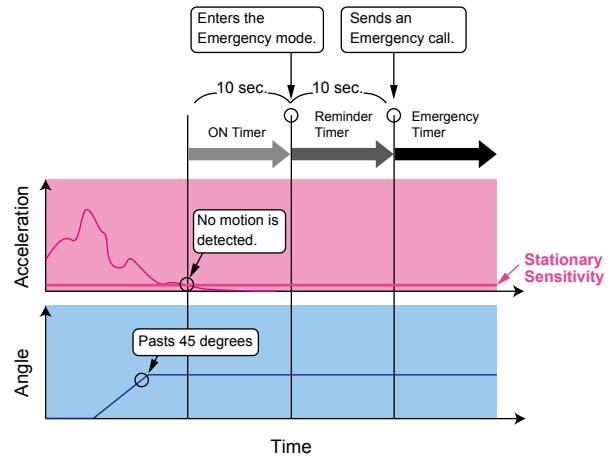

Emergency call

◇ Transmitting an Emergency call (Continued)
 The transceiver enters the Emergency mode through the following functions:

• **The Lone Worker function**

When no operation occurs for the ON Timer preset time.

- ① If a user pushes any key before the Reminder Timer set time expires, the Emergency mode is canceled.

(Example)

- ON Timer: 60 minutes
- Reminder Timer: 60 seconds

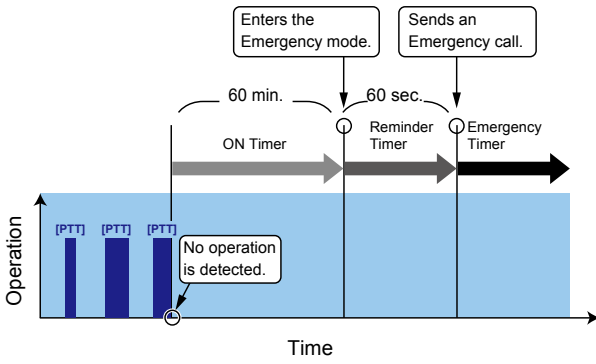

With Stationary

- When no operation occurs for the ON Timer preset time.

AND

- The transceiver is detected as stationary (no motion) for the ON Timer set time.

- ① If a user pushes any key, or moves the transceiver before the Reminder Timer set time expires, the Emergency mode is canceled.

(Example)

- ON Timer: 60 minutes
- Reminder Timer: 60 seconds

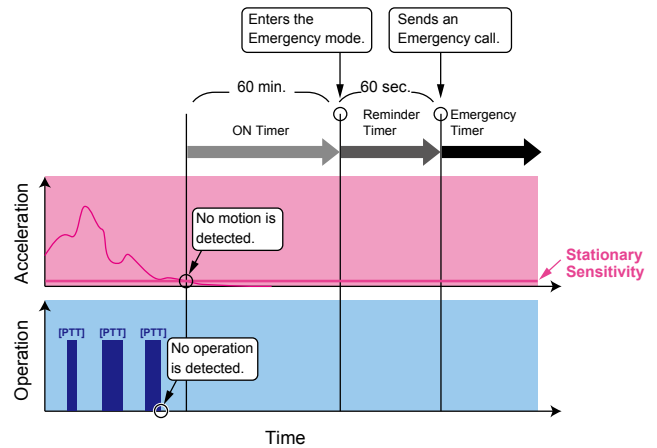

Emergency call

◇ Transmitting an Emergency call (Continued)
 The transceiver enters the Emergency mode through the following functions:

• **The Stationary Detection function**

When the transceiver is detected as being stationary (no motion) for the ON Timer preset time.
 ① If a user moves the transceiver during the Reminder Timer set time, the Emergency mode is canceled.

(Example)

ON Timer: 60 seconds
 Reminder Timer: 60 seconds

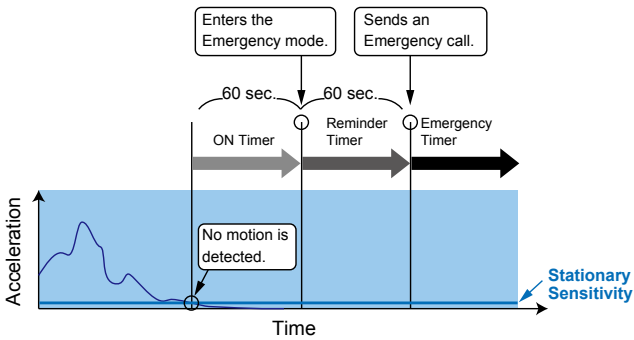

• **The Motion Detection function**

When the transceiver continuously moves for the ON Timer preset time.
 ① If a user holds down [Emergency] for the Emer SW OFF Timer set time, before the Reminder Timer set time expires, the Emergency mode is canceled.

(Example)

Motion Detection Timer: 10 seconds
 Reminder Timer: 10 seconds

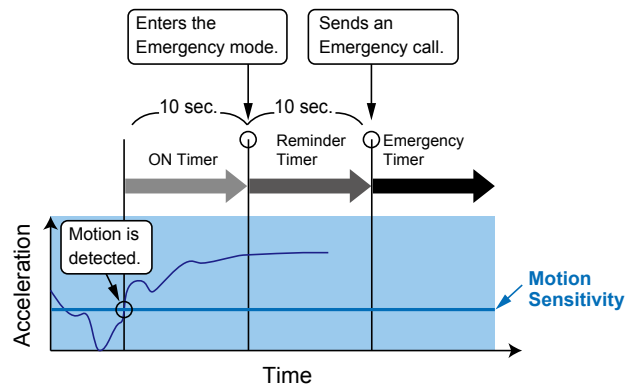

Scrambler

The Voice Scrambler function provides private communication between stations.

Push [Scrambler/Encryption] to toggle the Scrambler function ON or OFF.

- “” is displayed when the Scrambler function is ON.

① When the Scrambler function is ON, push [PTT] to make a private communication between stations by using a scrambled code.

Network Access Code (NAC)

NAC is a signaling system designed for digital radio communications.

When a channel is set up with an NAC, the squelch will open only when a call containing a matching NAC is received.

If a call containing a different NAC is made on the same channel a user is using, a user will not hear the call.

AquaQuake™ Water Draining function (for the Portable type transceiver)

By vibrating the speaker, the AquaQuake Water Draining function clears water from the speaker grill to maintain clear audio.

1. Hold down [AquaQuake] to turn ON the AquaQuake water draining function.
 - A low frequency vibration is generating to remove water from the speaker grill.
 - Water in the speaker grill may muffle the sound coming from the speaker.
2. Release the key to turn OFF the function.

NOTE:

- After the specified period of time expires, this function automatically stops, even if a user continues to hold down this key.
- This key works for only the internal speaker.

Section 5 SCAN OPERATION

Starting a Scan	5-2
Canceling a Scan	5-3
Selecting a Scan list	5-4
Setting or clearing a Scan tag	5-5

Starting a Scan

A Scan checks for signals on each channel and stops when a signal is received.

NOTE: Two or more channels must be preset to start a Scan.

<Key operation>

Push [Scan Start/Stop] to start a Scan.

- “Z” blinks.

① When a signal is detected, the Scan pauses on the channel until the signal disappears, and then the Scan resumes.

<Menu operation>

(Menu > Channel/Scan > **Scan Start/Stop**)

1. Push [Menu] to display the Menu screen.
2. Push [Left] or [Right] to select “Channel/Scan,” then push [OK].

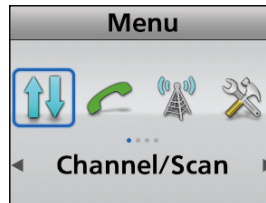

3. Push [Up] or [Down] to select “Scan Start/Stop,” then push [OK].



4. Push [Up] or [Down] to select “ON,” then push [OK].
 - The Scan starts.
 - ① When a signal is detected, the Scan pauses on the channel until the signal disappears, then the Scan resumes.

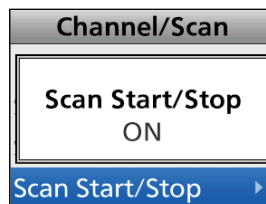
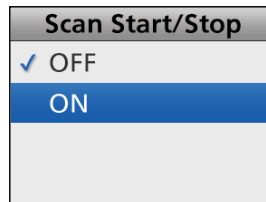

5. Hold down [Back] for 1 second to return to the standby screen.
 - “Z” blinks while scanning.

Canceling a Scan

<Key operation>

While scanning, push [Scan Start/Stop] to stop a Scan.

- “” disappears.

<Menu operation>

(Menu > Channel/Scan > **Scan Start/Stop**)

1. Push [Menu] to display the Menu screen.
2. Push [Left] or [Right] to select “Channel/Scan,” then push [OK].

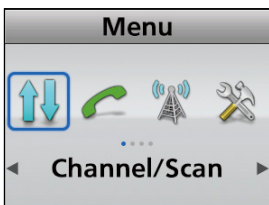

3. Push [Up] or [Down] to select “Scan Start/Stop,” then push [OK].

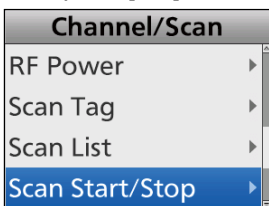

4. Push [Up] or [Down] to select “OFF,” then push [OK].
 - The Scan stops.
 - “Scan Start/Stop OFF” is briefly displayed.

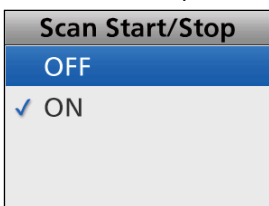

5. Hold down [Back] for 1 second to return to the standby screen.
 - “” disappears.

Selecting a Scan list

You can select a Scan list to be scanned. Channels included in the selected Scan list are scanned during a scan. When selecting a zone type Scan list, the channels that are in the same zone as the Scan start channel will be scanned.

<Key operation>

1. Hold down [Scan Start/Stop] for 1 second to display the "Scan List" screen.

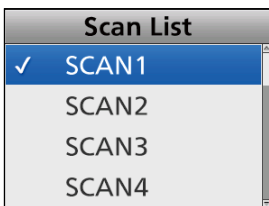

2. Push [Up] or [Down] to select a list, then push [OK].

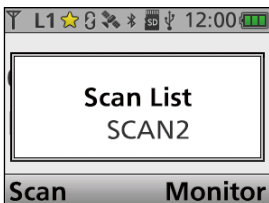
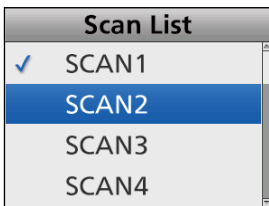

<Menu operation>

(Menu > Channel/Scan > **Scan List**)

1. Push [Menu] to display the Menu screen.
2. Push [Left] or [Right] to select "Channel/Scan," then push [OK].



3. Push [Up] or [Down] to select "Scan List," then push [OK].
 - Displays the "Scan List" screen.

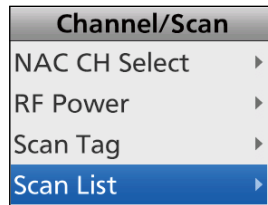

4. Push [Up] or [Down] to select a list, then push [OK].

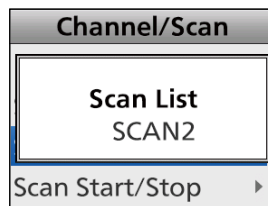
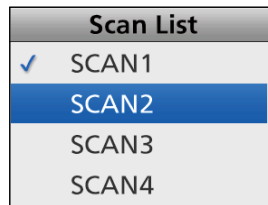

5. Hold down [Back] for 1 second to return to the standby screen.

Setting or clearing a Scan tag

You can set or clear a Scan tag to or from a channel in a Scan list.

The Scan tag channel is a target channel during a Scan.

<Key operation>

In a current Scan list:

1. Select a channel. (p. 3-4)
2. Push [Scan Add/Del (Tag)] to set or clear a Scan tag to or from the channel.
 - "★" is displayed for a Scan tag channel.

When setting a Scan tag:

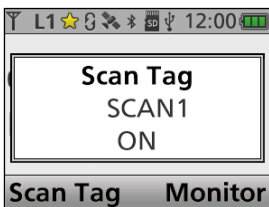

When clearing a Scan tag:

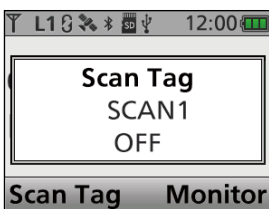

In a selected Scan list:

1. Select a channel. (p. 3-4)
2. Hold down [Scan Add/Del (Tag)] for 1 second to display the "Scan tag" screen.
3. Push [Up] or [Down] to select a Scan list.
4. Push [OK] to set or clear a Scan tag to or from the channel.

When setting a Scan tag:

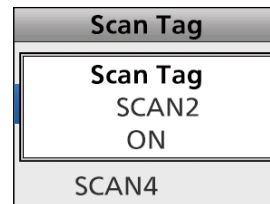
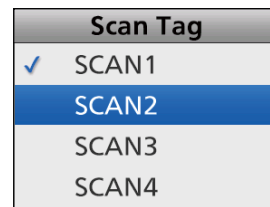

When clearing a Scan tag:

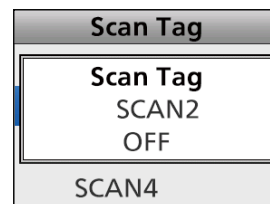
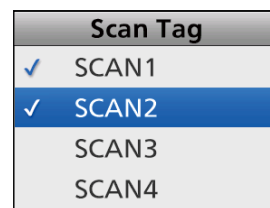

5. Hold down [Back] for 1 second to return to the standby screen.

Setting or clearing a Scan tag (Continued)

<Menu operation>

(Menu > Channel/Scan > **Scan tag**)

1. Select a channel. (p. 3-4)
2. Push [Menu] to display the Menu screen.
3. Push [Left] or [Right] to select "Channel/Scan," then push [OK].



4. Push [Up] or [Down] to select "Scan tag," then push [OK].
 - Displays the "Scan tag" screen.

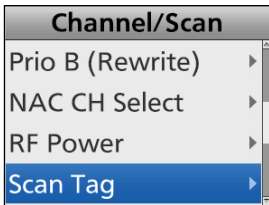

5. Push [Up] or [Down] to select a list, then push [OK].

When setting a Scan tag:

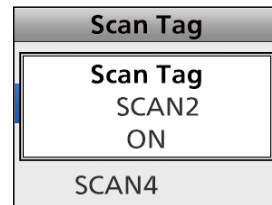
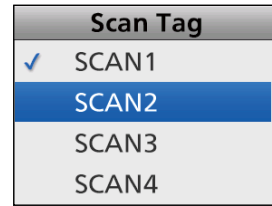

When clearing a Scan tag:

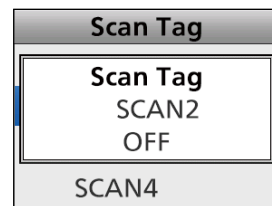
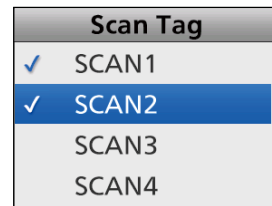

6. Hold down [Back] for 1 second to return to the standby screen.

Menu screen description	6-2
◇ Using the Menu screen	6-2
Menu items	6-3
Channel/Scan	6-8
Signaling/Call	6-9
Trunking	6-10
Functions	6-11
GPS	6-12
Voice Rec	6-13
Audio Setting	6-14
SD Card	6-15
Bluetooth	6-16
Clock	6-17
Vibration	6-17
Sensor	6-18
Display	6-18
Utility	6-19
Information	6-20
Control Head	6-21

Menu screen description

The user can open the “Menu” screen using the [Menu] key.
 In the “Menu” screen, the items are categorized.
 Depending on the presetting, the user can select various functions and set the transceiver settings in the “Menu” screen.

① The “Menu” screen has 2 display types: Icon type and List type. In this operating guide, the Icon type is used for the main illustration.

“Menu” screen

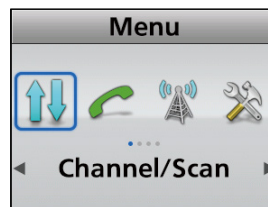

Icon type

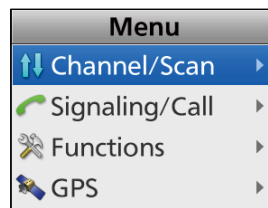

List type

NOTE: The language displayed on the “Menu” screen is set to English by default, but a dealer can change it to another language using the programming software.
 In this case, the item names are displayed on the screen in the language set by the dealer, instead of English.

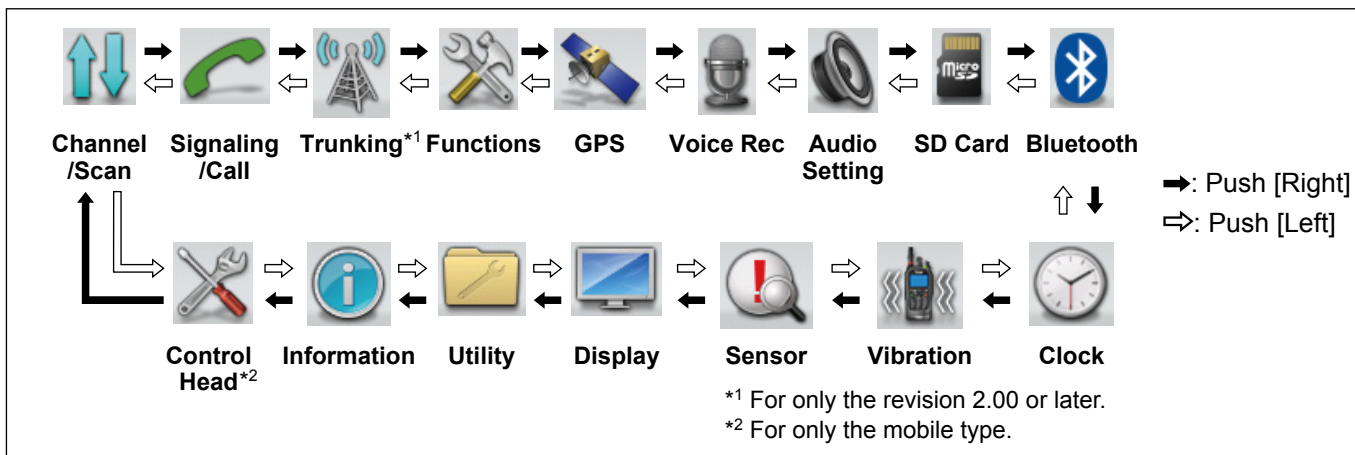

◇ Using the Menu screen

Example: Starting a Scan

1. Push [Menu] to display the Menu screen.
2. Push [Left] or [Right] to select “Channel/Scan,” then push [OK].



3. Push [Up] or [Down] to select “Scan Start/Stop,” then push [OK].



4. Push [Up] or [Down] to select “ON,” then push [OK].
 - The Scan starts.

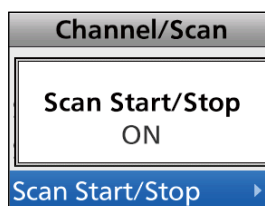
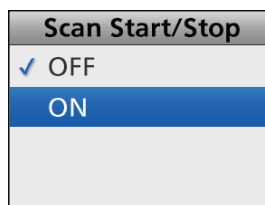

5. Hold down [Back] for 1 second to return to the standby screen.

Menu items

In the Menu screen, the items are categorized, as shown below.

Channel/Scan	C.Tone CH Select Sets the Continuous tone channel.	p. 6-8
	Compander Turns the Compander function ON or OFF.	p. 6-8
	Priority A CH Selects the Priority A channel.	p. 6-8
	Prio A (Rewrite) Sets a current channel as the Priority A channel.	p. 6-8
	Priority B CH Selects the Priority B channel.	p. 6-8
	Prio B (Rewrite) Sets a current channel as the Priority B channel.	p. 6-8
	NAC CH Select Sets the NAC channel.	p. 6-8
	RF Power Selects the output power for each channel.	p. 6-8
	Scan Tag (Scan Add/Del(Tag)) Sets or clears a Scan tag to or from a channel in a Scan list.	p. 6-8
	Scan List Sets a Scan list to be scanned.	p. 6-8
	Scan Start/Stop Starts or cancels a Scan.	p. 6-8
	Talkgroup Scan* Starts or cancels a Talkgroup Scan.	p. 6-8
	Scramble/Encrypt* Turns the Voice Scrambler/Encryption function ON or OFF.	p. 6-8
	CKR Select* Select the Encryption's Common Key Reference (CKR).	p. 6-8
	Talk Around Turns the Talk Around function ON or OFF.	p. 6-8
Zone Select Selects a Zone.	p. 6-8	
Signaling/Call	Call Menu Selects a calling destination and a call type.	p. 6-9
	Clear Incoming Clears the received call log from the Incoming list.	p. 6-9
	Clear Outgoing Clears the transmit call log from the Outgoing list.	p. 6-9
	DTMF Autodial Displays the "DTMF Autodial" screen. The preset DTMF codes are selectable.	p. 6-9
	Group Select Displays the "Group Select" screen. The preset Group IDs are selectable.	p. 6-9
	Incoming Displays a log of the received calls.	p. 6-9
	Individual Select Displays the "Individual Select" screen. The preset Individual IDs are selectable.	p. 6-9
	Message (Short Message) Displays the "Message" screen. The preset Messages are selectable.	p. 6-9

* For only the revision 2.00 or later.

Menu items (Continued)

Signaling/Call (Continued)	Outgoing Displays a log of the transmit calls	p. 6-9
	Status Displays the "Status" screen. The preset Status messages are selectable.	p. 6-9
Trunking*	Site Alias Displays the RFSS ID and Site ID, or the Site Alias name if entered.	p. 6-10
	Site Lock Lock the transceiver in the current registered site.	p. 6-10
	Site Select Select a site.	p. 6-10
	Site Change Beep Select whether or not to sound a Site Change Beep.	p. 6-10
	Band Scan Turns the Band Scan function ON or OFF.	p. 6-10
	Internal Hunt List Enters the Internal Hunt List mode.	p. 6-10
Functions	Ext CH Sel Mode Turns the External Channel Select mode ON or OFF.	p. 6-11
	Hook Scan Turns the On Hook Scan function ON or OFF. (Mobile only)	p. 6-11
	Horn Turns the Horn function ON or OFF. (Mobile only)	p. 6-11
	Lone Worker Turns the Lone Worker function ON or OFF.	p. 6-11
	Public Address Adjusts the Audio Output level of the connected Public Address (PA). (Mobile only)	p. 6-11
	RX Speaker Turns the RX speaker function ON or OFF. (Mobile only)	p. 6-11
	Surveillance Turns the Surveillance function ON or OFF.	p. 6-11
	USB Mode Select Selects the USB port mode.	p. 6-11
	VOX Turns the VOX function ON or OFF.	p. 6-11
	VOX Delay Sets the VOX Delay.	p. 6-11
	VOX Gain Sets the VOX gain.	p. 6-11
	Keyset* Selects a Keyset.	p. 6-11
	Zeroize* Zeroize the encryption key data.	p. 6-11
	Rekey* Request rekeying.	p. 6-11
GPS	GPS ON/OFF Turns the GPS function ON or OFF.	p. 6-12
	GPS Position (My Position) Displays the transceiver's current position.	p. 6-12

* For only the revision 2.00 or later.

Menu items (Continued)

Voice Rec	Call Recorder Starts or stops the audio recording.	p. 6-13
	Play Call Rec (Play Call Record) Enables the user to play back the recorded audio on the microSD card.	p. 6-13
Audio Setting	Mic Gain Sets the microphone sensitivity.	p. 6-14
	RX Noise Cancel Selects whether or not to suppress the receive audio noise to make the audio easy to hear.	p. 6-14
	TX Noise Cancel Selects whether or not to suppress the microphone input noise to make the audio easy to hear.	p. 6-14
	RX EQ Effect (RX Equalizer Effect) Selects the RX Equalizer Effect.	p. 6-14
	RX EQ Edit (RX Equalizer Edit) Enables the user to edit the RX Equalizer Effect.	p. 6-14
	TX EQ Effect (TX Equalizer Effect) Selects the TX Equalizer Effect.	p. 6-14
	TX EQ Edit (TX Equalizer Edit) Enables the user to edit the TX Equalizer Effect.	p. 6-14
SD Card	Load Setting <- SD Loads the transceiver's settings from a microSD card.	p. 6-15
	SD Unmount Unmounts a microSD card.	p. 6-15
	SD Format Formats the microSD card.	p. 6-15
	SD Information Displays the microSD card capacity and the time remaining for audio recording.	p. 6-15
	Software Update Updates the transceiver's firmware.	p. 6-15
Bluetooth	Bluetooth Turns the Bluetooth® function ON or OFF.	p. 6-16
	Bluetooth Reset Initializes the Bluetooth unit.	p. 6-16
	Bluetooth Auto Connect Select whether or not to automatically connect to the paired Bluetooth device when its power is turned ON.	p. 6-16
	Bluetooth Audio Setting Selects the AF Output device when a Bluetooth headset is connected.	p. 6-16
	BT Device Info (Bluetooth Device Information) Displays the installed Bluetooth unit name.	p. 6-16
	BT Device List (Bluetooth Device List) Displays the paired Bluetooth devices.	p. 6-16

Menu items (Continued)

Bluetooth (Continued)	Key Beep (VS-3) Sets the beep sound when the VS-3 Bluetooth HEADSET Custom Key ([PLAY]/[FWD]/[RWD]) is pushed.	p. 6-16
	P.Save (VS-3) (Power Save(VS-3)) Selects whether to operate in the Bluetooth headset's Battery Saving mode when the VS-3 Bluetooth HEADSET is connected.	p. 6-16
	PTT Beep (VS-3) Sets the beep sound when [PTT] is pushed on the VS-3 Bluetooth HEADSET.	p. 6-16
	One-touch PTT Sets the One-Touch PTT function when the Bluetooth headset is connected.	p. 6-16
	Waiting Pairing Enters the pairing request wait mode.	p. 6-16
Clock	Clock Adjust Sets the date and time.	p. 6-17
	Clock Auto Adjust Selects whether or not to automatically adjust the clock with data from the internal GPS receiver.	p. 6-17
	Clock Display Displays the current time on the transceiver's LCD.	p. 6-17
	DST (Daylight Saving Time) Selects whether or not to use Daylight Saving Time (DST) for the clock.	p. 6-17
Vibration	Opening Vibration Selects whether or not to vibrate the transceiver when it is turned ON. (Portable only)	p. 6-17
	Vibration Turns the Vibration function ON or OFF. (Portable only)	p. 6-17
	Key Vibration Selects whether or not to vibrate the transceiver when a user pushes a key. (Portable only)	p. 6-17
Sensor	Man Down Angle Sets the Emergency mode detection angle for the Man Down function. (Portable only)	p. 6-18
	Motion Sense Sets the acceleration sensor sensitivity to detect whether the user is moving or not, for the Motion Detection function. (Portable only)	p. 6-18
	Stationary Sense Sets the acceleration sensor sensitivity to detect if the user is stationary or not for the Stationary Detection function. (Portable only)	p. 6-18
Display	Backlight Sets the Key Backlight status.	p. 6-18
	Brightness Sets the LCD brightness level.	p. 6-18
	Dimmer Sets the LCD dimmer level.	p. 6-18
	Language Selects the language type used on the transceiver's display.	p. 6-18
	LCD Color Test Checks whether or not the LCD displays color correctly.	p. 6-18
	LCD Mode Sets the LCD Mode.	p. 6-18

Menu items (Continued)

Utility	System Beep Lv (System Beep Level) Sets the System Beep output level.	p. 6-19
	Emer Beep Lv (Emergency Beep Level) Sets the Beep output level when in the Emergency mode.	p. 6-19
	Key-touch Beep Lv (Key-touch Beep Level) Sets the Key-touch Beep output level.	p. 6-19
	Side Tone Lv (Side Tone Beep Level) Set the Side Tone Beep output level.	p. 6-19
	Opening Beep Lv (Opening Beep Level) Sets the Opening Beep output level.	p. 6-19
	Ringer Lv (Ringer Level) Sets the Ringer output level.	p. 6-19
	SQL Level Sets the squelch level.	p. 6-19
	Warning Beep Lv (Warning Beep Level) Sets the Warning Beep output level.	p. 6-19
	Announce Lv (Announce Level) Sets the Beep output level for the Channel Announce function.	p. 6-19
Information	Battery Info (Battery Information) Displays the battery voltage.	p. 6-20
	Comment Displays the transceiver's comments.	p. 6-20
	Firmware Info (Firmware Information) Displays the transceiver's firmware information.	p. 6-20
	Unit ID Displays the transceiver's unit ID.	p. 6-20
	RSSI/BER Displays the transceiver's RSSI (Received Signal Strength Indication) level and BER (Bit Error Rate).	p. 6-20
Control Head	Intercom Turns the Intercom function ON or OFF. (Mobile only)	p. 6-21
	Hanger Turns the Hanger function ON or OFF. (Mobile only)	p. 6-21
	TX AF Monitor Turns the TX AF Monitor function ON or OFF. (Mobile only)	p. 6-21
	SP Link (Speaker Link) Turns the Speaker Link function ON or OFF. (Mobile only)	p. 6-21
	Primary Mic Selects which CONTROL HEAD's microphone to input the audio when using the Auto TX function or PC commands. (Mobile only)	p. 6-21
	Head SP Out (Head Speaker Output) Selects whether or not to output the audio from the CONTROL HEAD or an external speaker. (Mobile only)	p. 6-21

Channel/Scan

C.Tone CH Select

In the Analog mode

Sets the Continuous tone channel. (p. 3-5)

Compander

In the Analog mode

Turns the Compander function ON or OFF. This function reduces noise components on the transmit audio for clear communication.

Priority A CH

Selects the Priority A channel. (p. 3-5)

Prio A (Rewrite)

Sets a current channel as the Priority A channel. (p. 3-5)

Priority B CH

Selects the Priority B channel. (p. 3-5)

Prio B (Rewrite)

Sets a current channel as the Priority B channel. (p. 3-5)

NAC CH Select

In the Digital mode

Sets the Network Access Code (NAC) channel. (p. 3-6)

RF Power

Selects the output power for each channel.

• Options: Low 1, Low 2, High

①“Low 1” is the lowest power level, and “High” is the highest power level.

①Lower output power during short-range communications may reduce the possibility of interference to other stations.

Scan Tag

Sets or clears a Scan tag to or from a channel in a Scan list. (p. 5-5)

Scan List

Sets a Scan list to be scanned. (p. 5-4)

Scan Start/Stop

Starts or cancels a Scan.

A Scan checks for signals on each channel and stops when a signal is received.

Talkgroup Scan (For only the revision 2.00 or later.)

Starts or cancels a Talkgroup Scan.

A Talkgroup Scan used to monitor the trunking group's communication. The function scans up to 8 Talkgroup IDs and Memory channels. If the transceiver is out of range, this item is disabled.

Scramble/Encrypt

In the Analog mode

Turns the Voice Scrambler function ON or OFF.

This function enables private communication between stations using a Scramble code.

①The same Scramble code must be set in all stations to communicate.

In the Digital mode (For only the revision 2.00 or later.)

Turns the Encryption function ON or OFF.

This function enables private communication between stations using an Encryption Key and Key ID.

①The same Encryption Key and Key ID must be set in all stations to communicate.

CKR Select (For only the revision 2.00 or later.)

Select the Encryption's Common Key Reference (CKR).

Talk Around

Turns the Talk Around function ON or OFF.

The Talk Around function equalizes the transmit frequency to the receive frequency, for direct (Simplex) communication.

Zone Select

Selects a Zone. (p. 3-3)

Signaling/Call

Call Menu

In the Analog mode (MDC 1200 only)

Selects a calling destination and a call type (Call Alert, Radio Check, Stun, Revive, and SelCall). After selecting, push [PTT] to transmit the call to the selected destination. (pp. 8-3 ~ 8-6)

In the Digital mode

Selects a calling destination and a call type (Status, Short Message, Call Alert, Remote Monitor, Radio Check, Radio Inhibit (Stun/Kill) and Radio Uninhibit (Revive). After selecting, push [PTT] to transmit the call to the selected destination. (pp. 7-3 ~ 7-9)

NOTE: When the call type is “Status” or “Short Message,” you can select or directly enter a message before transmitting it. After selecting or entering a message, push [PTT] to transmit it. See pages 7-4 ~ 7-6 for details.

Clear Incoming

In the Digital mode

In the Analog mode (MDC 1200 only)

Clears the received call log from the Incoming list. (p. 7-13)

Clear Outgoing

In the Digital mode

Clears the transmit call log from the Outgoing list. (p. 7-14)

DTMF Autodial

Displays the “DTMF Autodial” screen. Then, push [Up] or [Down] to select a DTMF code. After selecting, push [PTT] to transmit the selected DTMF code.

Group Select

In the Digital mode

Displays the “Group Select” screen. Then, push [Up] or [Down] to select a Group ID from the Group List. After selecting, push [PTT] to transmit a Group call. (p. 7-3)

Incoming

In the Analog mode (MDC 1200 only)

In the Digital mode

Displays a log of the received Individual call, Call Alert call, Status message, and Message. (pp. 7-12, 8-7)

Individual Select

In the Digital mode

Displays the “Individual Select” screen. Then, push [Up] or [Down] to select a Individual ID from the Individual ID List. After selecting, push [PTT] to send a Individual call. (p. 7-3)

Message

In the Analog mode (MDC 1200 only)

In the Digital mode

While in the Standby mode, push to display the “Message List” screen. Then, push [Up] or [Down] to select a message.

① See pages 7-3, 8-4 for details.

Outgoing

In the Digital mode

Displays a log of the transmitted Individual calls and Call Alert calls. (p. 7-14)

Status

In the Analog mode (MDC 1200 only)

In the Digital mode

Push to display the “Status List” screen. Then, push [Up] or [Down] to select a Status message.

① See pages 7-6, 8-14 for details.

Trunking (For only the revision 2.00 or later.)

Site Alias

Displays the RFSS ID and Site ID, or the Site Alias name if entered. You can enter the Site Alias name on the Site List screen.

Site Lock

Locks the transceiver in the current registered site. This function inhibits the transceiver from roaming other sites.

Site Select

Enter the site select mode.

Editing the RFSS ID:

1. While displaying the site, push [OK] to display its RFSS ID and the Site ID.
2. Hold down [OK] to enter the editing mode.
3. Push [Up] or [Down] to set.

Connecting to the site:

1. Hold down [OK] to connect to the site.
2. While displaying the site, hold down [OK] to connect to the site.

Site Change Beep

Select whether or not to sound a beep after registration and group affiliation are successful in the Trunking system.

Band Scan

Start or cancel the Band Scan.

① This function cannot be used while scanning, transmitting, or in the Conventional mode.

Internal Hunt List

Displays the Internal Hunt List.

Functions

Ext CH Sel Mode

Turns the External Channel Select function ON or OFF.

When this function is ON, Memory channels are selectable by only external input.

NOTE: This function is activated when the external unit is connected to the transceiver. To use the function, set “MCH Select:1” ~ “MCH Select:5” to any pins, in the Port Setting screen of the programming software.

Hook Scan (For the Mobile type)

Turns the On Hook Scan function ON or OFF.

When this function is ON, after putting the microphone in its hanger (on-Hook), the transceiver automatically starts scanning.

Horn (For the Mobile type)

Turns the Horn function ON or OFF.

When this function is ON, the HORN terminal of the D-Sub 25 pin or Option Connector 22 pin is activated after receiving a call with the Dec EXO or RX EXO setting is ON.

① This function is useful when the user is away from the transceiver.

① An external horn is required.

Lone Worker

Turns the Lone Worker function ON or OFF.

When this function is ON, the transceiver automatically enters the Emergency mode if no operation occurs during the preset period.

Public Address (For the Mobile type)

Adjusts the Audio Output level of the connected Public Address (PA).

RX Speaker (For the Mobile type)

Turns the RX speaker function ON or OFF.

When this function is ON, the received audio can be heard through an external speaker that is connected to the D-Sub 25 pin connector.

NOTE:

- This function is usable when an external speaker is connected to the D-Sub 25 pin connector.
- This function is useful when a user is out of the vehicle.
- The audio output level is linked to the transceiver's volume control.

Surveillance

Turns the Surveillance function ON or OFF.

When this function is ON, beeps are not heard and the backlight and the Status indicator do not light, even when a signal is received, or a key is pushed.

USB Mode Select

Selects the USB port mode.

- Data Transfer: Used for setting up the transceiver, updating the firmware, or using the PC control command.
- Card Reader: Reads the inserted card contents.

VOX

Turns the VOX function ON or OFF.

When this function is ON, the receive and transmit are automatically switched by detecting the user's voice.

NOTE: To use the function, a headset* and a VOX converter cable are required (user supplied).

*Bluetooth headset is also usable.

VOX Delay

Sets the VOX Delay.

The VOX Delay is the period of time the transceiver continues transmitting after the user stops speaking, and then the VOX switches to receive.

- Range: 0.5 ~ 3.0 seconds

NOTE: If you set the time too short, a pause in a conversation may be regarded as the end of conversation, and the transceiver will start receiving, even as the conversation continues.

VOX Gain

Sets the VOX gain.

The VOX function automatically switches between receive and transmit by detecting the user's voice.

- Range: 1 ~ 10

① Higher values make the VOX function more sensitive to sounds.

Keypad (For only the revision 2.00 or later.)

Enter the Keypad selection mode.

Push [Up] or [Down] to select the Keypad.

NOTE: To use the function, the optional UT-134 AES/DES ENCRYPTION UNIT is required.

Zeroize (For only the revision 2.00 or later.)

Zeroize the encryption key data that is programmed by the key loader.

Rekey (For only the revision 2.00 or later.)

Transmit a Key Management Message (KMM-Hello command) to a Key Management Facility (KMF) to request Rekeying.

GPS

GPS ON/OFF

Turns the GPS function ON or OFF.

When this function is ON, position data from the internal GPS receiver (Portable) or external GPS receiver (Mobile) is displayed in the "My Position" screen.

My Position

Displays the transceiver's current position.

My Position
34° 37' 23" N
135° 34' 17" E
ALT 5.4m

Voice Rec

Call Recorder



microSD card is required

● Rec Start

Push [OK] to start the audio recording.

- “” is displayed.

① Information

- While holding down [PTT], “” blinks, and the communication audio is recorded.
- “” is displayed when the microSD card has no free space and cannot record audio.
- While recording, “Rec Stop” is displayed in the “Call Recorder” screen.
- Once the recording has started, the recording will continue, even if the transceiver is restarted.
- To stop the recording, select “Rec Stop.”

● Rec Stop

Push [OK] to stop the audio recording.

- “” disappears.

Play Call Rec

microSD card is required

Do the following steps to play back the recorded audio on the microSD card.

Select “Play Call Rec,” then push [OK] to display the folders on the microSD card.

① These folders contain the audio files.

Playing back

1. Push [Up] or [Down] to select the folder that includes the desired file to play back, then push [OK].
2. Push [Up] or [Down] to select the file to play back, then push [OK].
3. Push [Play] to play back.
 - The selected file is played back.
 - See page 10-4 for details.
4. Hold down [Back] for 1 second to return to the standby screen.

NOTE:

- The folder name is automatically created, as shown in the example below:
Recording date is 2017/7/1
Folder name: 20170701
- The file name is automatically created, as shown in the example below:
Recording date and time is 2017/7/1 15:30:00
File name: 20170701_153000
- The audio is recorded onto a microSD card, and saved in the “wav” format. (“wav,” is not displayed on the transceiver’s screen.)
- The recorded audio can also be played back with a PC. (p. 10-7)

Audio Setting

Mic Gain

Sets the microphone sensitivity.

- Range: -8 (Minimum) ~ 5 (Maximum).
- ① Higher values make the microphone more sensitive to the user's voice.

RX Noise Cancel

Selects whether or not to suppress the receive audio noise to make the audio easy to hear.

- OFF: Turns OFF the function.
- 1, 2, or 3: Turns ON the function.
3 levels (1, 2, or 3) are selectable.
- ① Higher values suppress the audio noise more, but the audio quality becomes worse.

TX Noise Cancel

Selects whether or not to suppress the microphone input noise to make the audio easy to hear.

- OFF: Turns OFF the function.
- 1, 2, or 3: Turns ON the function.
3 levels (1, 2, or 3) are selectable.
- ① Higher values suppress the audio noise more, but the audio quality becomes worse.

RX Equalizer Effect

Selects the RX Equalizer Effect.

- Flat: Normal audio
- High Boost: Audio that emphasizes the high frequencies compared to "Flat"
- Mid Boost: Audio that emphasizes the midrange frequencies compared to "Flat"
- Low Boost: Audio that emphasizes the low frequencies compared to "Flat"
- Low Cut: Audio that cuts the low frequencies compared to "Flat"
- Custom: User customized audio

RX Equalizer Edit

Edits the RX Equalizer Effect.

- ① See to the right on how to edit.

TX Equalizer Effect

Selects the TX Equalizer Effect.

- Flat: Normal audio
- High Boost: Audio that emphasizes the high frequencies compared to "Flat"
- Mid Boost: Audio that emphasizes the midrange frequencies compared to "Flat"
- Low Boost: Audio that emphasizes the low frequencies compared to "Flat"
- Low Cut: Audio that cuts the low frequencies compared to "Flat"
- Custom: User customized audio

TX Equalizer Edit

Edits the TX Equalizer Effect.

- ① See below on how to edit.

TIP: How to edit the RX or TX Equalizer Effect

1. Push [Up] or [Down] to select "RX EQ Effect" or "TX EQ Effect," then push [OK].

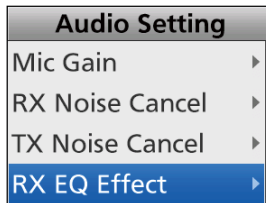

2. Push [Up] or [Down] to select an RX or TX Equalizer Effect you want to edit, then push [OK]. (Example: "6: Custom")

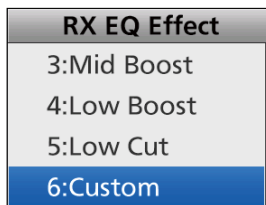

3. Push [Up] or [Down] to select "RX EQ Edit" or "TX EQ Edit," then push [OK].

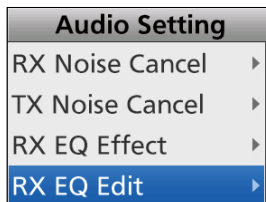

4. Push [Up] or [Down] to select a frequency, then push [OK]. (Example: "1.8 kHz")

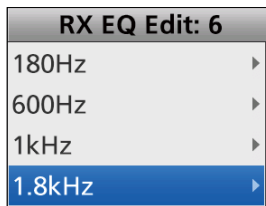

5. Push [Up] or [Down] to select an AF level, then push [OK]. (Example: "2 dB")

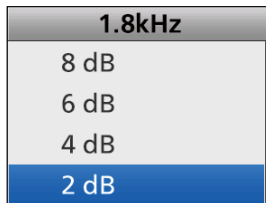

6. Hold down [Back] for 1 second to return to the standby screen.

SD Card

Load Setting <- SD

Loads the transceiver's settings from the microSD card.

①See "Loading the saved data files onto a microSD card" for details. (p. 9-5)

SD Unmount

Unmounts the microSD card.

NOTE: Before removing the microSD card, be sure to electrically unmount the card, when the transceiver is ON. Otherwise the data may be corrupted or deleted.

SD Format

Formats the microSD card.

If you use a brand new microSD card, be sure to format it.

①See "Formatting the microSD card" for details. (p. 9-4)

NOTE: Before using a microSD card with the transceiver, be sure to format all microSD cards with the built-in Format function. This creates a special folder on the card that you need for operations like updating the software. Format all cards, including a brand new microSD card, and even preformatted cards for PCs or other uses.

SD Information

Displays the microSD card capacity and the time remaining for voice recording.

①See "Displaying the information of the microSD card" for details. (p. 9-6)

Software Update

Updates the transceiver's firmware.

Bluetooth

Bluetooth

Turns the Bluetooth function ON or OFF.

- OFF: Turns OFF the function.
- ON: Turns ON the function.

Bluetooth Reset

Initializes the Bluetooth unit.

Only when the Bluetooth function is OFF, initialization can be done

Bluetooth Auto Connect

Select whether or not to automatically connect to the paired Bluetooth device when its power is turned ON.

- OFF: Does not connect to the paired device.
- ON: Automatically connects to the last connected device.

NOTE: The transceiver connects to the last connected device, if the connecting operation is performed on the device side, even if this item is set to OFF.

Bluetooth Audio Setting

Selects the AF Output device when a Bluetooth headset is connected.

- BT Only: Sets the Bluetooth headset as the AF Output device.
- BT & SP: Sets the Bluetooth headset and the transceiver's speaker as the AF Output devices.

BT Device Info

Displays the installed Bluetooth unit name, address, supported profile, and its version information.

BT Device List

Displays the paired Bluetooth devices.

To find other Bluetooth device, select "Find Device."

①See pages 11-4 and 11-7 for details.

Key Beep (VS-3)

Sets the beep sound when the optional VS-3 Bluetooth HEADSET Custom Key ([PLAY]/[FWD]/[RWD]) is pushed.

- OFF: No beep sounds.
- ON: A beep sounds.

P.Save (VS-3)

Selects whether to operate in the Bluetooth headset's Battery Saving mode when the optional VS-3 Bluetooth HEADSET is connected. When the Power Save is activated, the user cannot use the VOX function.

NOTE: When a third-party headset or a data device is connected, this function is automatically set to OFF, even if this item is set to ON.

- OFF: Turns OFF the function.
- ON: The Power Save mode is enabled when no communication or operation is performed for 120 seconds.

PTT Beep (VS-3)

Sets the beep sound when [PTT] is pushed on the optional VS-3 Bluetooth HEADSET.

- OFF: No beep sounds.
- ON: A beep sounds.

One-touch PTT

Sets the One-Touch PTT function when the Bluetooth headset is connected. The function enables a user to transmit without continuously holding down [PTT].

NOTE: When a third-party headset is connected, this function may automatically be set to ON, even if this item is set to OFF.

- OFF: Push [PTT] to transmit, then release to receive.
- ON: Push [PTT] to transmit, then push again to receive.

Waiting Pairing

Enters the pairing request wait mode. The transceiver waits for a pairing request from a Bluetooth device.

Clock

Clock Adjust

● **Date**

Sets the date (Year/Month/Day).

(The day of the week is automatically set.)

- Range: Year 2000 ~ 2099, Month/Day 1-1 ~ 12-31

● **Time**

Sets the current time.

(The time is displayed in the 24 hour format.)

- Range: 00:00:00 ~ 23:59:59 (in 1 second steps)

Clock Auto Adjust

Selects whether or not to automatically adjust the clock with data from the GPS receiver.

Clock Display

Displays the current time on the transceiver's LCD.

DST

Selects whether or not to use Daylight Saving Time (DST) for the clock.

Vibration

Opening Vibration (For the Portable types)

Selects whether or not to vibrate the transceiver when it is turned ON.

① To use this function, the Vibration function must be turned ON, in advance.

- OFF: Turns OFF the vibration.
- Pattern 01: The transceiver vibrates for 5 seconds.
- Pattern 02: The transceiver vibrates for 1 second three times.
- Pattern 03: The transceiver vibrates for 0.5 seconds four times.
- Pattern 04: The transceiver vibrates for 0.3 seconds eight times.
- Pattern 05 to 16: The transceiver vibrates, according to the customized pattern.

NOTE: You can customize the Vibration pattern, Vibration Repeat, and Interval time using the programming software.

Vibration (For the Portable types)

Turns the Vibration function ON or OFF.

To vibrate the transceiver, set each Vibration setting to ON using the programming software.

Depending on the Vibration setting, the transceiver may vibrate:

- When a call that includes a matching 2-Tone code is received.
- When a Call Alert is received.
- When a Short Message is received.
- When a Status call that includes a matching status number is received.
- When a user pushes a key.
- While in the Low Battery 1 state.
- While in the Low Battery 2 state.
- While in the Surveillance mode.

Key Vibration (For the Portable types)

Selects whether or not to vibrate the transceiver when a user pushes a key.

① To use this function, the Vibration function must be turned ON, in advance.

Sensor

Man Down Angle (For the Portable types)

Sets the Emergency mode detection angle for the Man Down function. If the transceiver leans past the set angle for the ON Timer time period, the transceiver enters the Emergency mode, and then a countdown starts.

- Options: 45, 60, or 75 degrees

Motion Sense (For the Portable types)

Sets the acceleration sensor sensitivity to detect whether the user is moving or not, for the Motion Detection function. This setting is for the Motion Detection function, and it determines the acceleration threshold level to activate the Motion Detection Timer.

- Range: 1 (high sensitivity) ~ 10 (low sensitivity).
- ① If you set a lower level, the transceiver will enter the Emergency mode more easily.

Stationary Sense (For the Portable types)

Sets the acceleration sensor sensitivity to detect if the user is stationary or not for the Stationary Detection function. This setting is used for the Stationary Detection function, and it determines the acceleration threshold level to activate the Stationary Detection's ON Timer (Sec).

- Range: 1 (high sensitivity) ~ 10 (low sensitivity).
- ① If you set at a higher level, the transceiver will enter the Emergency mode more easily.

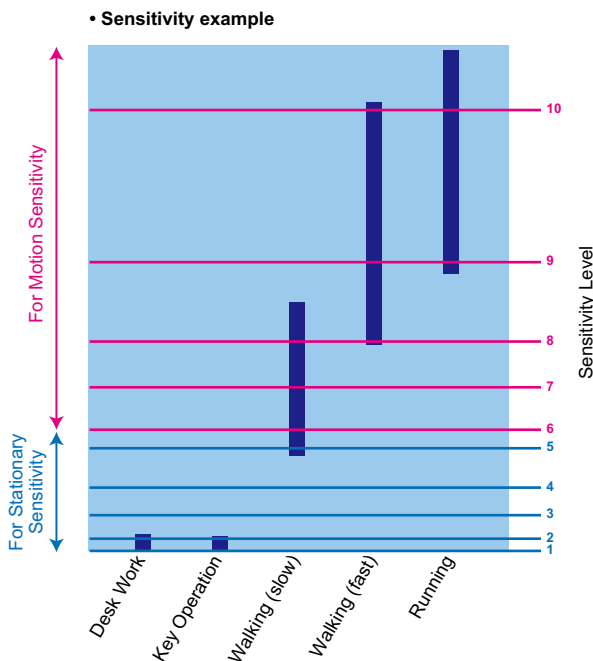

Display

Backlight

Sets the Key Backlight status.

For the Portable types

- OFF: Turns the display backlight continuously OFF.
- Auto: When any key except [PTT] is pushed, the backlight lights for 5 seconds.
- ON: Turns the backlight continuously ON.

For the Mobile type

- OFF: Turns the display backlight continuously OFF.
- Auto: Turns the backlight continuously ON with the Brightness setting level.
When the Dimmer terminal of the D-Sub 25 pin or Option Connector 22 pin is activated, the backlight lights dimly with the Dimmer setting level.
- ON: Turns the backlight continuously ON with the Brightness setting level.

Brightness

Sets the LCD brightness level.

- Range: 0 (the lowest) ~ 7 (the highest)

Dimmer

Sets the LCD dimmer level.

- Range: 0 (the lowest) ~ 7 (the highest)

NOTE: It is recommended to be the Dimmer level lower than the Brightness level.

Language

Selects the language type used on the transceiver's display.

- English: The contents are displayed in English.
- Other: The contents are displayed in a language other than English.

LCD Color Test

Checks whether or not the LCD displays color correctly.

LCD Mode

Sets the LCD Mode.

- Day: The LCD is set to the Day mode.
The Day mode is for daytime operation, and the display backlight color is set to white.
- Night: The LCD is set to the Night mode.
The Night mode is for nighttime operation, and the display backlight color is set to black.

Utility

System Beep Lv

Sets the System Beep output level.
The beep sounds when connecting to or blocked from the System. When a Linked option is selected, the beep level is adjustable with [VOL].

- Range: 1 ~ 5, 1 (Linked) ~ 5 (Linked), or OFF

NOTE: The lockout timer and TOT beeps cannot be turned OFF.

Emer Beep Lv

Sets the Beep output level when in the Emergency mode.
When a Linked option is selected, the beep level is adjustable with [VOL].

- Range: 1 ~ 5, 1 (Linked) ~ 5 (Linked), or OFF

Key-touch Beep Lv

Sets the Key-touch Beep output level.
When a Linked option is selected, the beep level is adjustable with [VOL].

- Range: 1 ~ 5, 1 (Linked) ~ 5 (Linked), or OFF

Side Tone Lv

Set the Side Tone Beep output level.
2-Tone or DTMF code signals are output as the Side Tone Beeps. When a Linked option is selected, the beep level can be adjusted with [VOL].

- Range: 1 ~ 5, 1 (Linked) ~ 5 (Linked), or OFF

Opening Beep Lv

Sets the Opening Beep output level.
When a Linked option is selected, the beep level is adjustable with [VOL].

- Range: 1 ~ 5, 1 (Linked) ~ 5 (Linked), or OFF

Ringer Lv

Sets the Ringer output level.
When a Linked option is selected, the Ringer level is adjustable with [VOL].

- Range: 1 ~ 5, 1 (Linked) ~ 5 (Linked), or OFF

SQL Level

Sets the squelch level.

- Range: 0 (open) ~ 9 (tight)

Warning Beep Lv

Sets the Warning Beep output level.
The Warning Beep sounds when:

- The battery is exhausted.
- An empty channel is selected.
- The Encryption key fails.

When a Linked option is selected, the beep level is adjustable with [VOL].

- Range: 1 ~ 5, 1 (Linked) ~ 5 (Linked), or OFF

Announce Lv

Sets the Beep output level for the Channel Announce function.
The transceiver announces the selected channel number.
When a Linked option is selected, the beep level is adjustable with [VOL].

- Range: 1 ~ 5, 1 (Linked) ~ 5 (Linked), or OFF

Information

Battery Info

Displays the battery voltage.

Comment

Displays the transceiver's comment.

The comment 1 is displayed on the first screen (Portable) or upper line (Mobile), and the comment 2 is on the second screen (Portable) or lower line (Mobile).

Firmware Info

Displays the transceiver's firmware information.

When an optional unit is installed, you can also check the unit information. Depending on the installed unit, only the name may be displayed.

Unit ID

Displays the transceiver's unit ID.

RSSI/BER

Displays the transceiver's RSSI (Received Signal Strength Indication) level and BER (Bit Error Rate).

Control Head

NOTE: These settings are settable only when connecting 2 control heads using the RMK-7 DUAL-HEAD SEPARATION KIT or HM-218 HAND MICROPHONE*.

* RMK-5 SEPARATION KIT is required to connect to the transceiver.

Intercom (For the Mobile type)

Turns the Intercom function ON or OFF.

When this function is ON, the users can communicate each other through their control head's microphones.

① While communicating using the Intercom function, you can use only [PTT] and [VOL].

1. Select "Intercom," and then push [OK].
 - The Intercom function is ON.
2. Hold down or release [PTT] to communicate.
3. Push [OK] to turn the Intercom function OFF.

Hanger (For the Mobile type)

Selects which control head, or simply select both control heads, to automatically start scanning after putting the microphone in the hanger (on-Hook).

① To use this function, turn ON the Hook Scan function in the "Functions" category.

① Other Hanger actions can be set in the CS-F7500 PROGRAMMING SOFTWARE.

- HEAD 1 & HEAD 2: Automatically starts scanning after putting both microphones in their hangers.
- HEAD 1: Automatically starts scanning after putting the microphone in the CONTROL HEAD 1 hanger.
- HEAD 2: Automatically starts scanning after putting the microphone in the CONTROL HEAD 2 hanger.

TX AF Monitor (For the Mobile type)

Turns the TX AF Monitor function ON or OFF.

When this function is ON, the user can monitor the audio that is transmitted on the other control head.

SP Link (For the Mobile type)

Turns the SP Link function ON or OFF.

When this function is ON, the audio volume settings between the two control heads are linked.

- OFF: The audio volume settings are not linked, and are individually set at each control head.
- HEAD 1: The audio volume settings are linked, and are equally set on CONTROL HEAD 1.
- HEAD 2: The audio volume settings are linked, and are equally set on CONTROL HEAD 2.

Primary Mic (For the Mobile type)

Selects which control head's microphone to use when transmitting without pushing [PTT], such as when using the Auto TX function or PC commands.

- Options: HEAD 1, HEAD 2

Head SP Out (For the Mobile type)

Selects whether or not to output the audio from the control head.

① The user can individually set to each control head, and also the HM-218.

- OFF: The audio is not output from the control head's front speaker or from the HM-218.
- ON: The audio is output from the control head's front speaker or from the HM-218.

General.....	7-2
Transmitting a call	7-3
◇ Transmitting an Individual call.....	7-3
◇ Transmitting a Talkgroup call	7-3
◇ Transmitting a Status Message	7-4
◇ Transmitting a Short Message	7-5
◇ Transmitting a Call Alert call	7-6
◇ Transmitting a Status Query call.....	7-6
◇ Transmitting a Remote Monitor call	7-7
◇ Transmitting a Radio Check call	7-7
◇ Transmitting a Radio Inhibit call.....	7-8
◇ Transmitting a Radio Uninhibit call	7-8
◇ Transmitting a Phone call	7-9
◇ Transmitting an Emergency call	7-9
Receiving a call	7-10
◇ Receiving an Individual call	7-10
◇ Receiving a Group call.....	7-10
◇ Receiving a Status message	7-10
◇ Receiving a Short message.....	7-10
◇ Receiving a Call Alert call	7-10
◇ Receiving a Status Query call.....	7-10
◇ Receiving a Remote Monitor call	7-10
◇ Receiving a Radio Check call	7-10
◇ Receiving a Radio Inhibit call.....	7-11
◇ Receiving a Phone call	7-11
◇ Receiving an Emergency call	7-11
Incoming list.....	7-12
◇ Displaying the Incoming list	7-12
◇ Deleting the Incoming list.....	7-13
Displaying the Outgoing list.....	7-14
◇ Displaying the Outgoing list	7-14
◇ Deleting the Outgoing list.....	7-14
Encryption function.....	7-15

General

APCO Project-25 (P25) is designed for public safety digital radio, and allows you to make a call to a specific station (Individual call) or to a particular group (Talkgroup call) in the Conventional mode.

Other P25 transceivers on the channel will not listen in on a call that does not match their Individual/Talkgroup group ID or Network Access Code (NAC).

Moreover, the following functions and calls are available: Call Alert function, Radio Inhibit/Uninhibit function, Remote Monitor function, Radio Check function, Status Message, Short Message, Status Query, Phone Call and Emergency Call function. NAC matching is not necessary for the above functions and calls.

Each transceiver has a unique ID, and it allows to be substituted with an alphanumeric name, if programmed.

You can use this ID (or name) to select a target station to call, and the ID (or name) of the target station is displayed after receiving a call.

Transmitting a call

APCO P25 mode operation enables you to make a call to a specific station (Individual call) or to a particular group (Group call). Other digital mode transceivers on the channel will not receive a call that does not match their Individual or Talkgroup ID and/or Network Access Code (NAC).

◆ Transmitting an Individual call

Individual call enables to make a call to a specific station, and it provides private communication.

(Menu > Signaling/Call > **Individual Select**)

1. Push [Menu] to display the Menu screen.
2. Push [Left] or [Right] to select “Signaling/Call,” then push [OK].

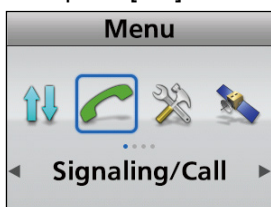

3. Push [Up] or [Down] to select “Individual Select,” then push [OK].

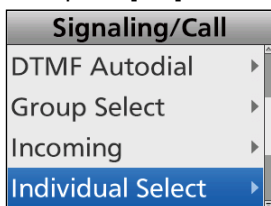

4. Select the target Individual station, then push [PTT] to transmit an Individual call.

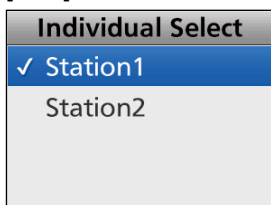

5. Hold down [PTT] to speak.
6. Release [PTT] to receive.

NOTE: If the following settings are configured using the CS-F7500 PROGRAMMING SOFTWARE, the Individual ID (or name) is displayed while receiving.
 (Digital > Option > Individual Option > **Unit ID Display on Receive**)
 (Digital > Option > Talkgroup Option > **Unit ID Display on Receive**)

TIP: Push [Individual] to directly display the “Individual Select” screen in step 4 above.

◆ Transmitting a Talkgroup call

A Talkgroup call enables to make a call to a specific Talkgroup only.

① The Talkgroup ID ‘65535’ is used for the All Call.

(Menu > Signaling/Call > **Group Select**)

1. Push [Menu] to display the Menu screen.
2. Push [Left] or [Right] to select “Signaling/Call,” then push [OK].

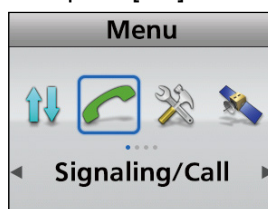

3. Push [Up] or [Down] to select “Group Select,” then push [OK].

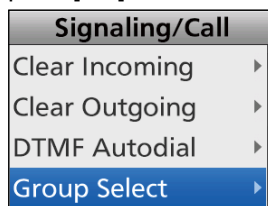

4. Select the target Talkgroup, then push [PTT] to transmit a Talkgroup call.

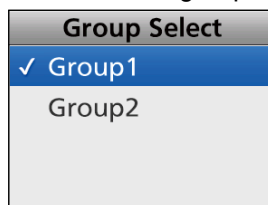

5. Hold down [PTT] to speak.
6. Release [PTT] to receive.

NOTE: If the following settings are configured using the CS-F7500 PROGRAMMING SOFTWARE, the Talkgroup ID (or name) is displayed:
 • When the operating channel or zone is changed.
 • When [PTT] is pushed.
 • While receiving.
 (Digital > Option > Talkgroup Option > **Talkgroup Display on Mode Change, Talkgroup Display on PTT, Talkgroup Display on Receive**)

TIP: Push [Group] to directly display the “Group Select” screen in step 4 above.

Transmitting a call (Continued)

◇ **Transmitting a Status Message**

You can transmit a preset simple message.
A voice signal cannot be sent at the same time.

(Menu > Signaling/Call > **Call Menu**)

1. Push [Menu] to display the Menu screen.
2. Push [Left] or [Right] to select “Signaling/Call,” then push [OK].



3. Push [Up] or [Down] to select “Call Menu,” then push [OK].

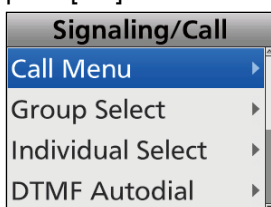

4. Select “Status,” then push [OK].

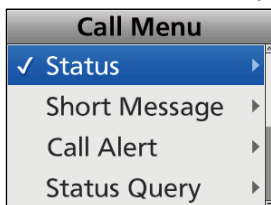

5. Select a Status Message, then push [OK].

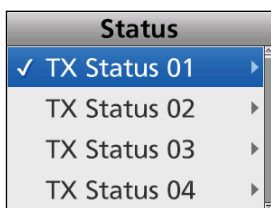

6. Select the target Individual station, then push [PTT] to transmit the message.

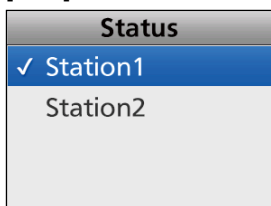

- “Success” is displayed after receiving an acknowledgment from the target station.
- “Failed” is displayed if the target station does not send back an acknowledgment.

NOTE: If the following settings are configured using the CS-F7500 PROGRAMMING SOFTWARE, the Status message can be automatically transmitted when the transceiver is turned ON or OFF.

- ① Set the Status message to be transmitted in “Power ON Status” or “Power OFF Status” item, respectively.
- ① Set the target station ID in “Power Status ID.” (Digital > Status > Status Setting)

TIP:

- You can also transmit a Status message through “Status.” (Menu > Signaling/Call > **Status**)
- Push [Call Menu] to directly display the “Call Menu” screen in step 4 to the left.
- Push [Status] to directly display the “Status” screen in step 5 to the left.
- Hold down [Status] for 1 second transmit the preset Status Message to the currently selected destination.

Transmitting a call (Continued)

◇ **Transmitting a Short Message**

A user can transmit a preset message of up to 100 characters.

(Menu > Signaling/Call > **Call Menu**)

1. Push [Menu] to display the Menu screen.
2. Push [Left] or [Right] to select “Signaling/Call,” then push [OK].



3. Push [Up] or [Down] to select “Call Menu,” then push [OK].



4. Select “Short Message,” then push [OK].

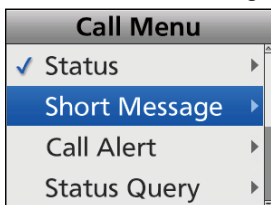

5. Select the target Individual station, then push [OK].



6. Select a Message, then push [PTT] to transmit it.

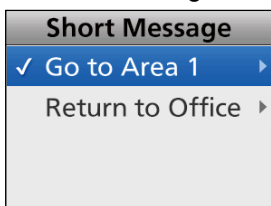

- “Success” is displayed after receiving an acknowledgment from the target station.
- “Failed” is displayed if the target station does not send back an acknowledgment.

TIP:

- You can also transmit a Short Message through “Short Message.”
(Menu > Signaling/Call > **Short Message**)
- Push [Call Menu] to directly display the “Call Menu” screen in step 4 to the left.
- Push [Short Message] to directly display the “Short Message” screen in step 5 to the left.
- Hold down [Status] for 1 second transmit the preset Status Message to the currently selected destination.

Transmitting a call (Continued)

◇ **Transmitting a Call Alert call**

A Call Alert call is designed to notify the target station user who may be away from his/her transceiver, or in noisy environment with an alert and indication. If the target station is active when a signal is received, an acknowledgment is automatically transmitted. The calling station can verify whether a target station is active or not.

(Menu > Signaling/Call > **Call Menu**)

1. Push [Menu] to display the Menu screen.
2. Push [Left] or [Right] to select "Signaling/Call," then push [OK].

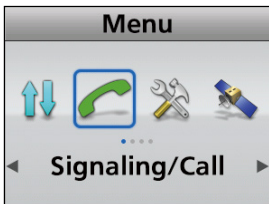

3. Push [Up] or [Down] to select "Call Menu," then push [OK].

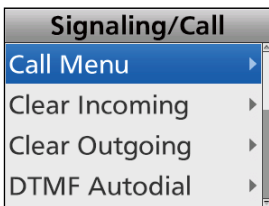

4. Select "Call Alert," then push [OK].

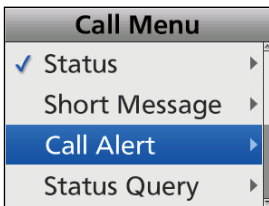

5. Select the target Individual station, then push [PTT] to transmit a Call Alert call.

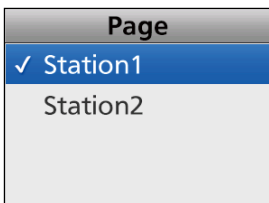

- "Success" is displayed after receiving an acknowledgment from the target station.
- "Failed" is displayed if the target station does not send back an acknowledgment.

TIP:

- Push [Call Menu] to directly display the "Call Menu" screen in step 4 as described above.
- Push [Call Alert] to directly display the "Call Alert" screen in step 5 as described above.

◇ **Transmitting a Status Query call**

A Status Query call requests the target transceiver to transmit status messages. When a Status Query call is received, the target transceiver automatically transmits the last transmitted Status message.

(Menu > Signaling/Call > **Call Menu**)

1. Push [Menu] to display the Menu screen.
2. Push [Left] or [Right] to select "Signaling/Call," then push [OK].

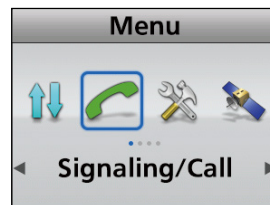

3. Push [Up] or [Down] to select "Call Menu," then push [OK].

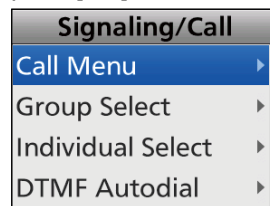

4. Select "Status Query," then push [OK].

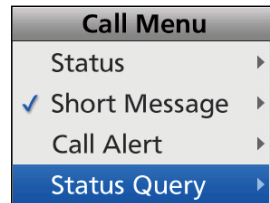

5. Select the target Individual station, then push [PTT] to transmit a Status Query call.

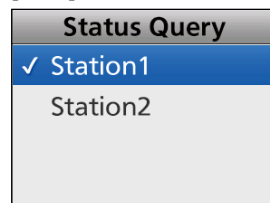

- "Status Query" and the message from the target station are displayed.
- "Failed" is displayed if the target station does not send back an acknowledgment.

TIP: Push [Call Menu] to directly display the "Call Menu" screen in step 4 as described above.

Transmitting a call (Continued)

◇ **Transmitting a Remote Monitor call**

Remote Monitor call enables to send a signal that requires the target station to transmit the microphone audio.

(Menu > Signaling/Call > **Call Menu**)

1. Push [Menu] to display the Menu screen.
2. Push [Left] or [Right] to select "Signaling/Call," then push [OK].

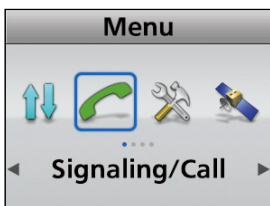

3. Push [Up] or [Down] to select "Call Menu," then push [OK].

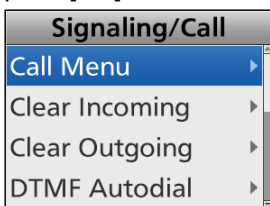

4. Select "Remote Monitor," then push [OK].

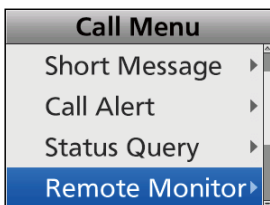

5. Select the target Individual station, then push [PTT] to transmit a Remote Monitor call.

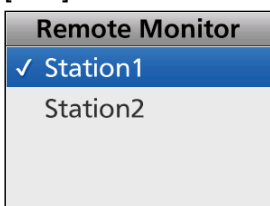

- "Success" is displayed after receiving an acknowledgment from the target station.
- "Failed" is displayed if the target station does not send back an acknowledgment.

6. The microphone audio can be heard for the preset period of time.

TIP: Push [Call Menu] to directly display the "Call Menu" screen in step 4 above.

◇ **Transmitting a Radio Check call**

A Radio Check call enables to determine whether the target station is turned ON, within the communication range and on the channel, without requiring any action from the target station user.

(Menu > Signaling/Call > **Call Menu**)

1. Push [Menu] to display the Menu screen.
2. Push [Left] or [Right] to select "Signaling/Call," then push [OK].

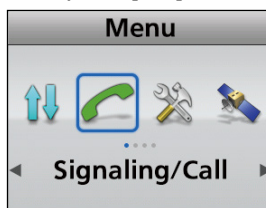

3. Push [Up] or [Down] to select "Call Menu," then push [OK].

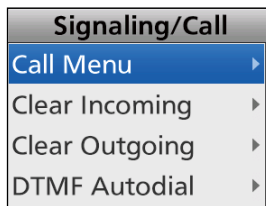

4. Select "Radio Check," then push [OK].

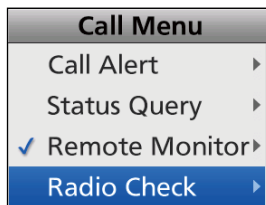

5. Select the target Individual station, then push [PTT] to transmit a Radio Check call.

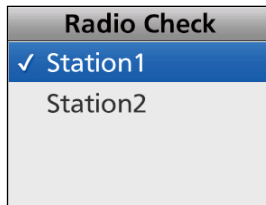

- "Success" is displayed after receiving an acknowledgment from the target station.
- "Failed" is displayed if the target station does not send back an acknowledgment.

TIP: Push [Call Menu] to directly display the "Call Menu" screen in step 4 above.

Transmitting a call (Continued)

◇ **Transmitting a Radio Inhibit call**

A Radio Inhibit function enables to send a signal that inhibits (stun or kill, depending on the presetting) the target transceiver.

(Menu > Signaling/Call > **Call Menu**)

1. Push [Menu] to display the Menu screen.
2. Push [Left] or [Right] to select “Signaling/Call,” then push [OK].

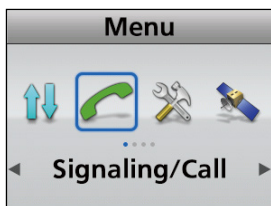

3. Push [Up] or [Down] to select “Call Menu,” then push [OK].

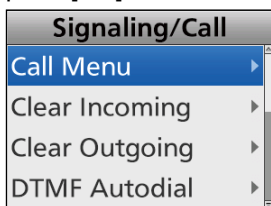

4. Select “Radio Inhibit,” then push [OK].

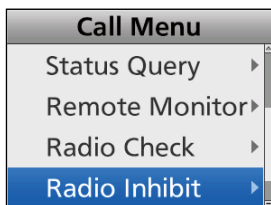

5. Select the target Individual station, then push [PTT] to transmit a Radio Inhibit call.

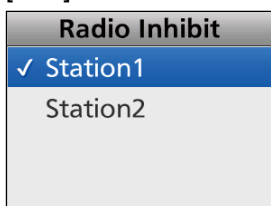

- “Success” is displayed after receiving an acknowledgment from the target station.
- “Failed” is displayed if the target station does not send back an acknowledgment.

TIP: Push [Call Menu] to directly display the “Call Menu” screen in step 4 above.

◇ **Transmitting a Radio Uninhibit call**

A Radio Uninhibit function enables to send a signal that revives the inhibited transceiver.

(Menu > Signaling/Call > **Call Menu**)

1. Push [Menu] to display the Menu screen.
2. Push [Left] or [Right] to select “Signaling/Call,” then push [OK].

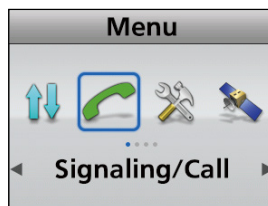

3. Push [Up] or [Down] to select “Call Menu,” then push [OK].

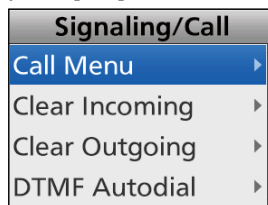

4. Push [Up] or [Down] to select “Radio Uninhibit,” then push [OK].

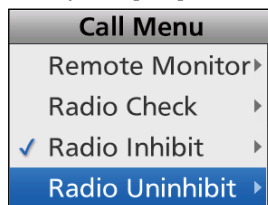

5. Push [Up] or [Down] to select the target Individual station, then push [PTT] to transmit a Radio Uninhibit call.

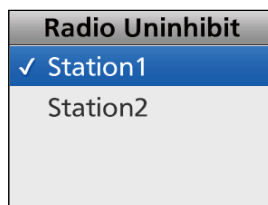

- “Success” is displayed after receiving an acknowledgment from the target station.
- “Failed” is displayed if the target station does not send back an acknowledgment.

TIP: Push [Call Menu] to directly display the “Call Menu” screen in step 4 above.

Transmitting a call (Continued)

◇ **Transmitting a Phone call**

A user can make a Phone call that is similar to standard phone calls. A transceiver and a PSTN (Public Switched Telephone Network) can access each other. When no phone number is preset, a Phone call cannot be made.

◇ **Transmitting an Emergency call**

An APCO P25 mode Emergency call can be transmitted in the same way as the 2-Tone or MDC 1200 signaling operation. See “Emergency call” for details. (pp. 4-3 ~ 4-6)

(Menu > Signaling/Call > **Call Menu**)

1. Push [Menu] to display the Menu screen.
2. Push [Left] or [Right] to select “Signaling/Call,” then push [OK].

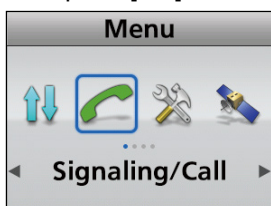

3. Push [Up] or [Down] to select “Call Menu,” then push [OK].

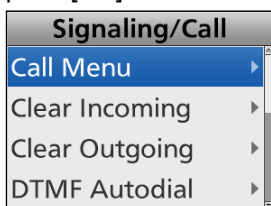

4. Select “Phone,” then push [OK].



5. Select the target telephone station, then push [PTT] to transmit a Phone call.

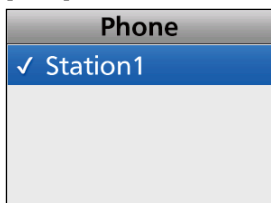

• Beeps (PiPi) sound after the Phone call is connected to the target station.

① If your Phone call is not connected, push [Back] to return to the standby mode.

6. Hold down [PTT] to speak.
7. Release [PTT] to receive.
8. After conversation is finished, push [Back] to disconnect the Phone call.

TIP: Push [Call Menu] to directly display the “Call Menu” screen in step 4 above.

Receiving a call

◇ Receiving an Individual call

- When an Individual call is received:
 - Mute is released.
 - The calling station name (or ID) is displayed while receiving the signal.*

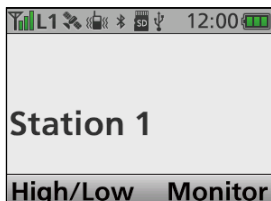

- Hold down [PTT] to speak.
- Release [PTT] to receive.

◇ Receiving a Group call

- When a Group call is received:
 - Mute is released.
 - The Group name and the calling station name (or ID) are displayed while receiving the signal.*

① When an All Call is received, "All Call" is displayed. In that case, you cannot reply to it.

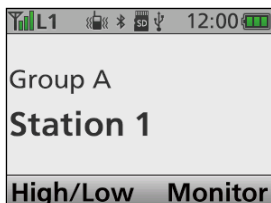

- Hold down [PTT] to speak.
- Release [PTT] to receive.

◇ Receiving a Status message

- When a Status message is received:
 - Beeps sound.
 - The Status message and the calling station name (or ID) are displayed.*
 - "✉" blinks.
 - "🔔" may be displayed or blink.*
 - Portable type transceivers may vibrate.*

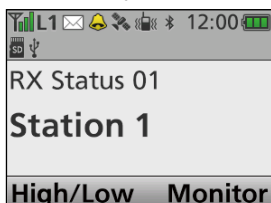

- Push [Back] to stop the display indication.

◇ Receiving a Short message

- When a Short message is received:
 - Beeps sound.
 - The Short message and the calling station or Group name (or ID) are displayed.
 - "✉" blinks.
 - "🔔" may be displayed or blink.*
 - Portable type transceivers may vibrate.*

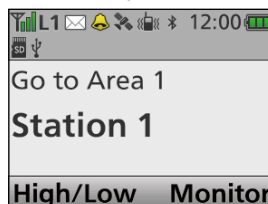

- Push [Back] to stop the display indication.

◇ Receiving a Call Alert call

- When a Call Alert call is received:
 - Beeps sound.
 - "Call Alert" and the calling station name (or ID) are displayed.*
 - "🔔" may be displayed or blink.*
 - Portable type transceivers may vibrate.*

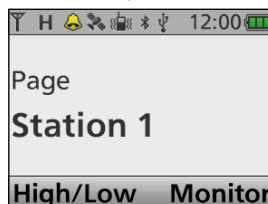

① The transceiver automatically transmit an acknowledgment.

- Push [Back] to stop the display indication.

◇ Receiving a Status Query call

When a Status Query call is received, the transceiver automatically transmits the last transmitted Status message.

◇ Receiving a Remote Monitor call

When a Remote monitor call is received, the microphone audio is automatically transmitted for the preset period of time.

◇ Receiving a Radio Check call

When a Radio check call is received, the transceiver automatically transmits an acknowledgment call.

*Depending on the presetting.

Receiving a call (Continued)

◇ Receiving a Radio Inhibit call

If a Radio Inhibit is received, the transceiver will display the preset text (example: "SORRY") and you cannot receive nor transmit.

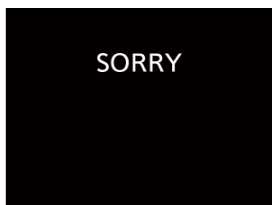

When a "Decode Action" is set to "Stun":

To use the transceiver again, do the following.

- Receive an Uninhibit call.
- Enter the password.
- Setup again using the CS-F7500.

When a "Decode Action" is set to "Kill":

To use the transceiver again, setup again using the CS-F7500.

(Digital > Radio Inhibit/Uninhibit > Decode Action)

◇ Receiving a Phone call

1. When a Phone call is received:
 - Ringers sound.
 - "PHONE CALL" and  are displayed.

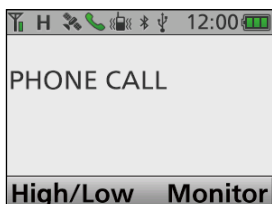

2. Hold down [PTT] to speak.
3. Release [PTT] to receive.
4. After the conversation is finished, push [Back] to disconnect the Phone call.

◇ Receiving an Emergency call

1. When an Emergency call is received:
 - Beeps sound.
 - The preset Emergency text (example: "Emergency") and the calling station name (or ID) are alternately displayed.

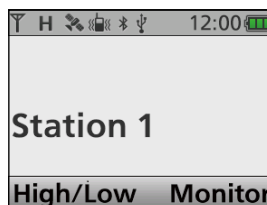
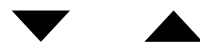
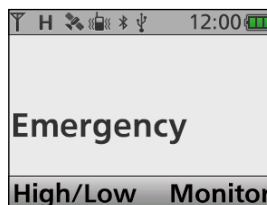

2. When the Send Ack function is turned ON, the transceiver automatically transmits an acknowledgment to the calling station.
3. Hold down [PTT] to speak.
4. To stop the beep and display indication, do the following.
 - Turn OFF the transceiver
 - Change the channel
 - Push the [Back] key

Incoming list

The transceiver saves a log of the received Individual calls, Call Alert calls, Status messages, and Messages in the memory, depending on the presetting.

Up to 10 Message/Status or 5 Voice/Call Alert calls can be saved in the log, and the oldest call record is erased when an 11th (Message/Status) or 6th (Voice/Call Alert) call is received. However, once the transceiver is turned OFF, the all records are erased.

◇ Displaying the Incoming list

(Menu > Signaling/Call > Incoming)

1. Push [Menu] to display the Menu screen.
2. Push [Left] or [Right] to select "Signaling/Call," then push [OK].

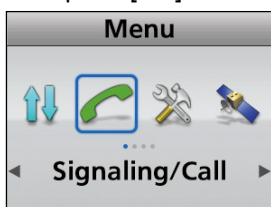

3. Push [Up] or [Down] to select "Incoming," then push [OK].
 - ① If there is no log, an error beep sounds and the log is not displayed.



4. Push [Up] or [Down] to select "Voice/Call Alert" or "Message/Status," then push [OK].

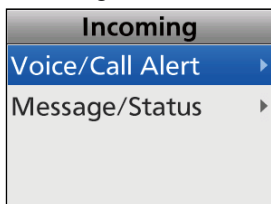

- Voice/Call Alert: The received Individual call and Call Alert call logs are saved.
- Message/Status: The received Status message and Message logs are saved.

5. When "Voice/Call Alert" is selected in step 4: The "Voice/Call Alert" screen is displayed.

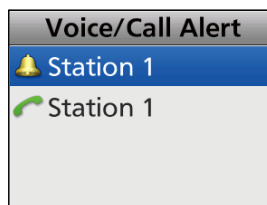

- The calling station name (or ID) is displayed.
- ① "📞" is for the Individual calls.
- ① "🔔" is for the Call Alert calls.

TIP: When the "Voice/Call Alert" screen is displayed, skip step 6 and go to step 7.

- When "Message/Status" is selected in step 4: The "Message/Status" screen is displayed.

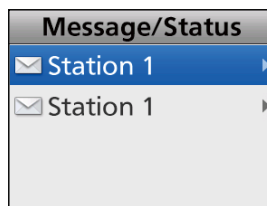

- The calling station name (or ID) is displayed.
- ① "✉" is for the Status message or Short Message.

6. Push [Up] or [Down] to select the log, then push [OK].
 - The message content is displayed.

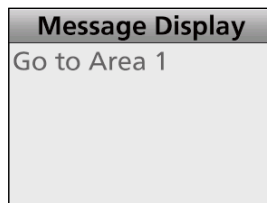

7. Hold down [Back] for 1 second to return to the standby screen.

Incoming list (Continued)

◇ **Deleting the Incoming list**

The receive call log can be deleted from the Incoming list.

(Menu > Signaling/Call > **Clear Incoming**)

1. Push [Menu] to display the Menu screen.
2. Push [Left] or [Right] to select “Signaling/Call,” then push [OK].



3. Push [Up] or [Down] to select “Clear Incoming,” then push [OK].

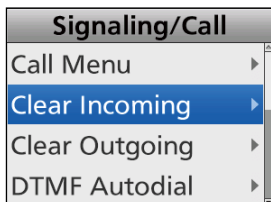

4. Push [Up] or [Down] to select “Voice/Call Alert” or “Message/Status” to be deleted, then push [OK].

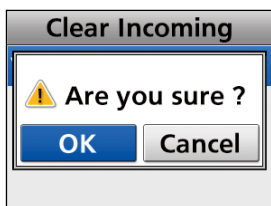
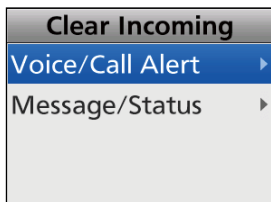

- Voice/Call Alert: The received Individual calls and Call Alert calls are saved in the log.
 - Message/Status: The received Status messages and Messages are saved in the log.
5. Push [Left] or [Right] to select “OK,” then push [OK].
 - The selected call log is deleted from the Incoming list.
 6. Hold down [Back] for 1 second to return to the standby screen.

Displaying the Outgoing list

The transceiver saves a log of the transmitted Individual calls, Group calls and Call Alert calls in the memory.

Up to 5 calls can be saved in the log, and the oldest call record is erased when a 6th call is received.

However, once the transceiver is turned OFF, the all records are erased.

◇ Displaying the Outgoing list

(Menu > Signaling/Call > **Outgoing**)

1. Push [Menu] to display the Menu screen.
2. Push [Left] or [Right] to select "Signaling/Call," then push [OK].

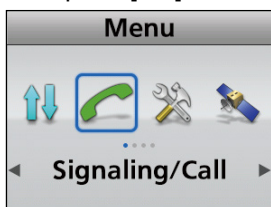

3. Push [Up] or [Down] to select "Outgoing," then push [OK].

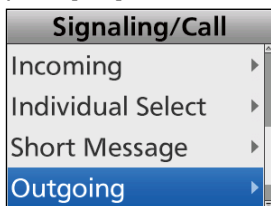

4. The calling station name (or ID) is displayed in the "Outgoing" screen.

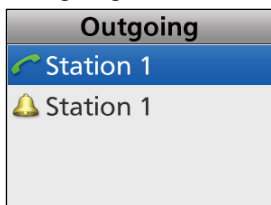

① "📞" is for the Individual calls.

① "🔔" is for the Call Alert calls.

5. Hold down [Back] for 1 second to return to the standby screen.

◇ Deleting the Outgoing list

The transmit call log can be deleted from the Outgoing list.

(Menu > Signaling/Call > **Clear Outgoing**)

1. Push [Menu] to display the Menu screen.
2. Push [Left] or [Right] to select "Signaling/Call," then push [OK].

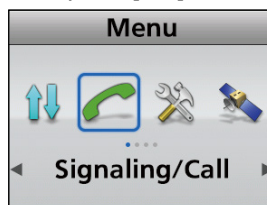

3. Push [Up] or [Down] to select "Clear Outgoing," then push [OK].

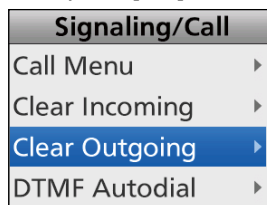

4. Push [Left] or [Right] to select "OK," then push [OK].



• The selected call log is deleted from the Outgoing list.

5. Hold down [Back] for 1 second to return to the standby screen.

Encryption function

The encryption function enables voice scrambling, which provides private digital communication between stations.

When an encrypted call is received, the squelch will open only when the call contains a matching Key ID*. If a call containing a different Key ID or Cipher Type* is made on the same channel, the squelch will not open, and the user will not hear the call.

* Depending on the presetting, opening the squelch may also require that a matching RAN is included in the call.

Push [Scrambler/Encryption] to toggle the Encryption function ON or OFF.

• “” is displayed when the Encryption function is ON.

① When the Encryption function is ON, push [PTT] to make an encrypted call.

General.....	8-2
Transmitting a call	8-3
◇ Transmitting a PTT ID	8-3
◇ Transmitting an MDC Emergency call	8-3
◇ Transmitting an MDC Emergency Acknowledgment.....	8-3
◇ Transmitting an MDC Status call	8-3
◇ Transmitting an MDC Message call	8-4
◇ Transmitting an MDC Call Alert call	8-4
◇ Transmitting an MDC Radio Check call	8-5
◇ Transmitting an MDC Stun call	8-5
◇ Transmitting an MDC Revive call.....	8-6
◇ Transmitting an MDC Selective Call (SelCall)	8-6
Receiving a call	8-7
◇ Receiving a PTTID.....	8-7
◇ Receiving an MDC Status call	8-7
◇ Receiving an MDC Message call	8-7
◇ Receiving an MDC Call Alert call	8-7
◇ Receiving an MDC Radio Check call.....	8-7
◇ Receiving an MDC Stun call or Revive call	8-8
◇ Receiving an MDC Selective Call (SelCall)	8-8
◇ Receiving an MDC Emergency call	8-8
Incoming Call log function	8-9
◇ Checking the Incoming call log	8-9
◇ Deleting the Incoming call log.....	8-9

General

This function is usable in only the Analog mode.

The MDC 1200 signaling system enhances your transceiver's capabilities. You can receive or transmit PTT IDs, Emergency, Selective Call (SelCall), Call Alert, Radio Check, Stun, Revive, Status, and Message calls.

Set one of the assignable software key functions for the MDC 1200 system operations. (pp. 2-12 ~ 2-21)

NOTE: Set the related settings using the CS-F7500 PROGRAMMING SOFTWARE when using the MDC 1200 system. See the Help file for details.

Transmitting a call

◇ Transmitting a PTT ID call

You can transmit a call with your station ID. When another station receives a PTT ID call, your station ID is displayed.

Push [PTT] to make a call.

- Beeps sound, depending on the presetting.
- Your station ID is transmitted when you push [PTT] (at the beginning of the transmission) or release [PTT] (at the end of transmission), depending on the presetting.

◇ Transmitting an MDC Emergency call

An MDC Emergency call can be transmitted in the same way as the 2-Tone or APCO P25 mode operation. See “Emergency call” for details. (pp. 4-3 ~ 4-6)

The transceiver can also be set to keep the microphone open in the Emergency mode to monitor the situation, depending on the presetting.

◇ Transmitting an MDC Emergency Acknowledgment

When receiving an MDC Emergency call, an MDC Emergency Acknowledgment is automatically transmitted, depending on the presetting.

◇ Transmitting an MDC Status call

An MDC Status call enables you to send a preset Status call. There are 16 kinds of Status calls. In addition, the transceiver can send an MDC Status Poll call that make the target station to automatically transmit a Status call, depending on the presetting.

(Menu > Signaling/Call > Call Menu > **Status**)

1. Push [Menu] to display the Menu screen.
2. Push [Left] or [Right] to select “Signaling/Call,” then push [OK].

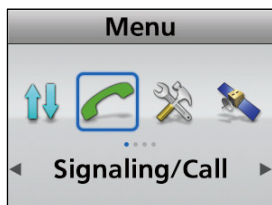

3. Push [Up] or [Down] to select “Call Menu,” then push [OK].



4. Push [Up] or [Down] to select “Status,” then push [OK].

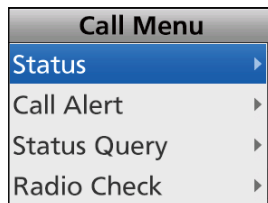

5. Select a Status call, then push [PTT] to transmit an MDC Status call.

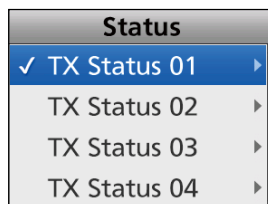

- “Success” is displayed after receiving an acknowledgment from the target station.
- “Failed” is displayed if the target station does not send back an acknowledgment.

TIP:

- You can also transmit a Status call through “Call Menu.” (Menu > Signaling/Call > Call Menu > **Status**)
- Push [Status] to directly display the “Status” screen in step 4 above.
- Hold down [Status] for 1 second to transmit the preset Status call that is set in the “Status” screen.

Transmitting a call (Continued)

◇ **Transmitting an MDC Message call**

You can send a MDC Message call. There are 16 kinds of Messages.

(Menu > Signaling/Call > **Message**)

1. Push [Menu] to display the Menu screen.
2. Push [Left] or [Right] to select “Signaling/Call,” then push [OK].



3. Push [Up] or [Down] to select “Call Menu,” then push [OK].

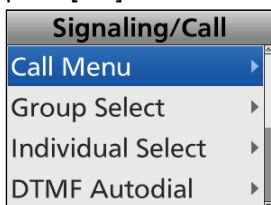

4. Push [Up] or [Down] to select “Message,” then push [OK].

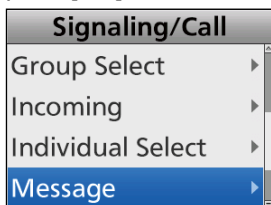

5. Select a Message, then push [PTT] to transmit an MDC Message call.

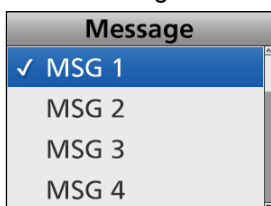

- “Success” is displayed after receiving an acknowledgment from the target station.
- “Failed” is displayed if the target station does not send back an acknowledgment.

TIP:

- You can also transmit a Message through “Call Menu.”
(Menu > Signaling/Call > Call Menu > **Message**)
- Push [Message] to directly display the “Message” screen in step 4 above.
- Hold down [Message] for 1 second to transmit the preset message that is set in the “Message” screen.

◇ **Transmitting an MDC Call Alert call**

An MDC Call Alert call enables you to notify another user who may be away from the transceiver that you want to talk.

It also informs a user who is away from their transceiver, that they have received a call from another user.

(Menu > Signaling/Call > Call Menu > **Call Alert**)

1. Push [Menu] to display the Menu screen.
2. Push [Left] or [Right] to select “Signaling/Call,” then push [OK].

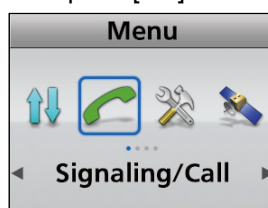

3. Push [Up] or [Down] to select “Call Menu,” then push [OK].

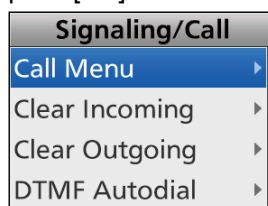

4. Select “Call Alert,” then push [OK].

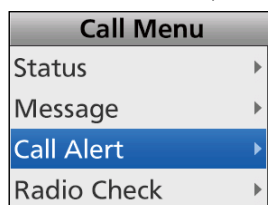

5. Select a station or group ID, then push [PTT] to transmit an MDC Call Alert call.

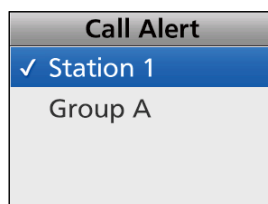

- “Success” is displayed after receiving an acknowledgment from the target station.
- “Failed” is displayed if the target station does not send back an acknowledgment.

TIP: Push [Call Menu] to directly display the “Call Menu” screen in step 4 above.

Transmitting a call (Continued)

◇ **Transmitting an MDC Radio Check call**

An MDC Radio Check call enables the user to determine whether the target station is turned ON, within the communication range and on the channel, without requiring any action from the target station user.

(Menu > Signaling/Call > Call Menu > **Radio Check**)

1. Push [Menu] to display the Menu screen.
2. Push [Left] or [Right] to select “Signaling/Call,” then push [OK].

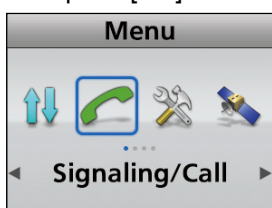

3. Push [Up] or [Down] to select “Call Menu,” then push [OK].

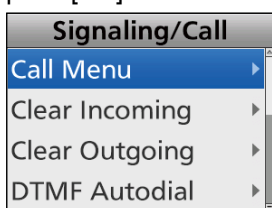

4. Select “Radio Check,” then push [OK].

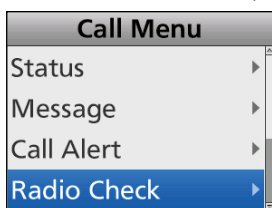

5. Select a station ID, then push [PTT] to transmit an MDC Radio Check call.

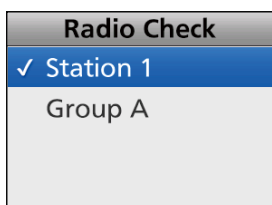

- “Success” is displayed after receiving an acknowledgment from the target station.
- “Failed” is displayed if the target station does not send back an acknowledgment.

TIP: Push [Call Menu] to directly display the “Call Menu” screen in step 4 above.

◇ **Transmitting an MDC Stun call**

An MDC Stun call remotely disables the transceiver.

(Menu > Signaling/Call > Call Menu > **Stun**)

1. Push [Menu] to display the Menu screen.
2. Push [Left] or [Right] to select “Signaling/Call,” then push [OK].

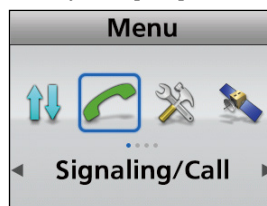

3. Push [Up] or [Down] to select “Call Menu,” then push [OK].

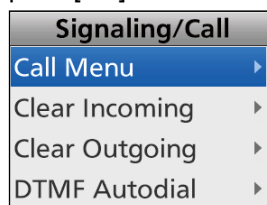

4. Select “Stun,” then push [OK].

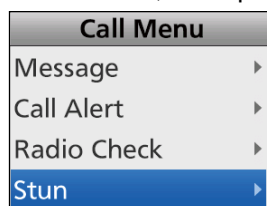

5. Select a station ID, then push [PTT] to transmit an MDC Stun call.

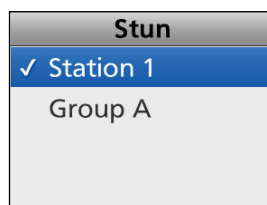

- “Success” is displayed after receiving an acknowledgment from the target station.
- “Failed” is displayed if the target station does not send back an acknowledgment.

TIP: Push [Call Menu] to directly display the “Call Menu” screen that is described in step 4 above.

Transmitting a call (Continued)

◇ Transmitting an MDC Revive call

An MDC Revive call revives a stunned transceiver to normal operation.

(Menu > Signaling/Call > Call Menu > **Revive**)

1. Push [Menu] to display the Menu screen.
2. Push [Left] or [Right] to select “Signaling/Call,” then push [OK].



3. Push [Up] or [Down] to select “Call Menu,” then push [OK].

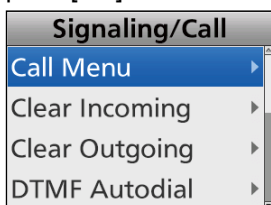

4. Select “Revive,” then push [OK].

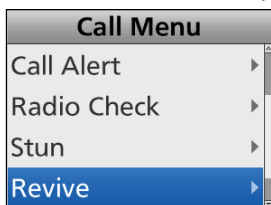

5. Select a station ID, then push [PTT] to transmit an MDC Revive call.

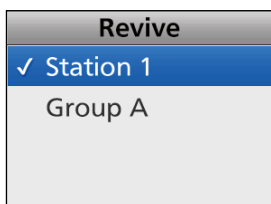

- “Success” is displayed after receiving an acknowledgment from the target station.
- “Failed” is displayed if the target station does not send back an acknowledgment.

TIP: Push [Call Menu] to directly display the “Call Menu” screen in step 4 above.

◇ Transmitting an MDC Selective Call (SelCall)

An MDC SelCall enables you to make a call to a specific station, or to a particular group. Other MDC 1200 system transceivers on the channel do not receive a SelCall that does not include the matching station or group ID.

(Menu > Signaling/Call > Call Menu > **SelCall**)

1. Push [Menu] to display the Menu screen.
2. Push [Left] or [Right] to select “Signaling/Call,” then push [OK].

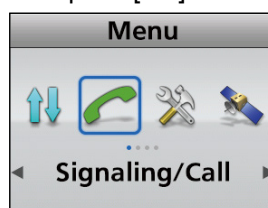

3. Push [Up] or [Down] to select “Call Menu,” then push [OK].

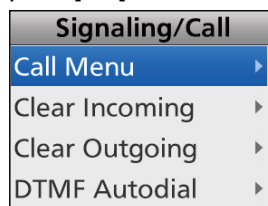

4. Select “SelCall.”

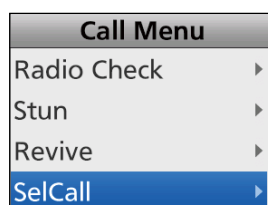

5. Select a station or group ID, then push [PTT] to transmit an MDC SelCall.

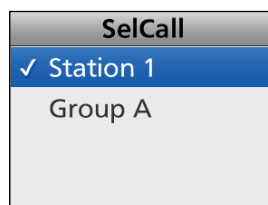

- “” is displayed while transmitting the SelCall.

TIP: Push [Call Menu] to directly display the “Call Menu” screen in step 4 above.

Receiving a call

◇ Receiving a PTT ID call

When a PTT ID call is received:

- Beeps sound.*
- Portable type transceivers may vibrate.*
- The calling station's name (or ID) is displayed.

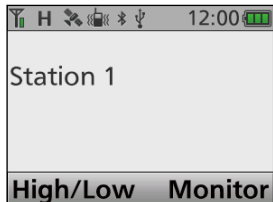

◇ Receiving an MDC Status call

When an MDC Status call is received.

- Beeps sound.
- The calling station's name (or ID) and the Status message are displayed for preset period of time.

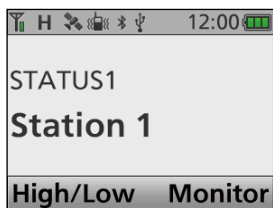

◇ Receiving an MDC Message call

When an MDC Message call is received.

- Beeps sound.
- The calling station's name (or ID) and the message are displayed.

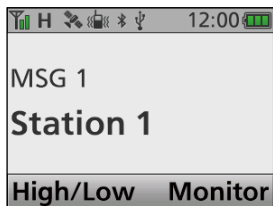

① To return to the Standby screen, push [Back].

◇ Receiving an MDC Call Alert call

When an MDC Call Alert call is received:

- Beeps sound.
- "🔔" blinks.
- The calling station's ID is displayed.

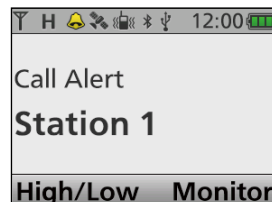

① To return to the Standby screen, push [Back].

◇ Receiving an MDC Radio Check call

When a Radio check call is received, the transceiver automatically transmits an acknowledgment call.

*Depending on the presetting.

Receiving a call (Continued)

◇ Receiving an MDC Stun call or Revive call

If an MDC Stun call is received that matches your station ID, the transceiver will display the preset text (example: "SORRY") and you cannot receive nor transmit.

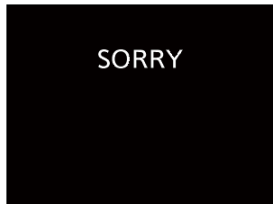

To use the transceiver again, do the following.

- Receive an MDC Revive call that matches your station ID.
- Enter the password.
- Setup again using the CS-F7500.

◇ Receiving an MDC Selective Call (SelCall)

When an MDC SelCall is received:

- Beeps sound.
- "🔊" is displayed.
- "🔔" blinks.
- The calling station's ID is displayed.

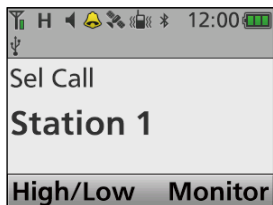

Hold down [PTT] to speak.

◇ Receiving an MDC Emergency call

When an MDC Emergency call is received:

- Beeps sound.
- Portable type transceivers may vibrate.*
- The calling station's ID and "Emergency" is displayed.

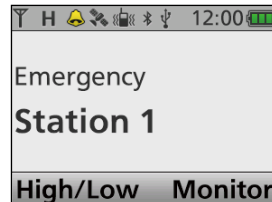

① The transceiver automatically may transmit an acknowledgment to the calling station, depending on the setting.

1. Hold down [PTT] to speak.
2. To stop the beep and display indication, do the following.
 - Turn OFF the transceiver
 - Change the channel
 - Push a key

*Depending on the presetting.

Incoming Call log function

After receiving an MDC SelCall, Call Alert call, or Emergency call, the call log may be displayed, depending on the presetting. Up to 5 calls can be memorized, and the oldest call is deleted when a 6th call is received.

◇ Checking the Incoming call log

(Menu > Signaling/Call > Incoming)

1. Push [Menu] to display the Menu screen.
2. Push [Left] or [Right] to select "Signaling/Call," then push [OK].

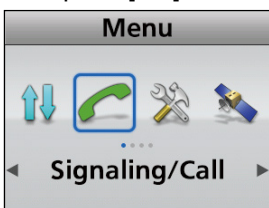

3. Push [Up] or [Down] to select "Incoming," then push [OK].
 - ① If there is no log, an error beep sounds and the log is not displayed.

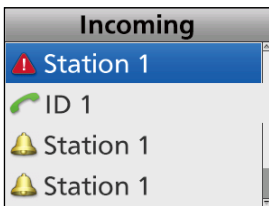

- ① "⚠" is for the Emergency calls.
- ① "☎" is for the SelCalls.
- ① "🔔" is for the Call Alert calls.

4. Hold down [Back] for 1 second to return to the standby screen.

◇ Deleting the Incoming call list

The receive call log can be deleted from the Incoming list.

(Menu > Signaling/Call > Clear Incoming)

1. Push [Menu] to display the Menu screen.
2. Push [Left] or [Right] to select "Signaling/Call," then push [OK].

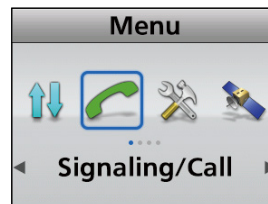

3. Push [Up] or [Down] to select "Clear Incoming," then push [OK].

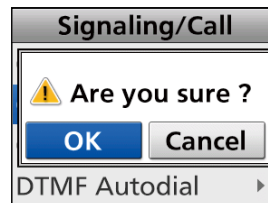
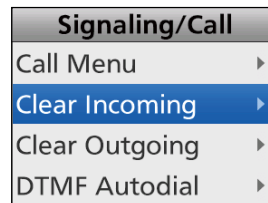

4. Push [Left] or [Right] to select <OK>, then push [OK].
 - The selected call log is deleted from the Incoming list.
5. Hold down [Back] for 1 second to return to the standby screen.

Section 9

ABOUT THE microSD CARD

About the microSD card	9-2
Saving data onto the microSD card.....	9-2
Inserting or removing the microSD card	9-3
◇ Inserting	9-3
◇ Removing.....	9-3
Unmounting the microSD card	9-4
Formatting the microSD card.....	9-4
Loading the saved data files onto a microSD card	9-5
Displaying the information of the microSD card	9-6
Backing up the data saved on the microSD card onto a PC ..	9-7
◇ About the microSD card's folder contents.....	9-7
◇ Making a backup file on your PC	9-8

About the microSD card

The microSD or microSDHC card is not supplied by Icom. User supplied.

Users can use a microSDHC of up to 32 GB. Icom has checked the compatibility with the following microSDHC cards.

(As of August 2017)

Brand	Type	Memory size
SanDisk®	microSDHC	4 GB
		8 GB
		16 GB
		32 GB

- ① The above list does not guarantee the card's performance.
- ① Through the rest of this document, the microSDHC card is simply called the microSD card or the card.

TIP: Icom recommends that a user save the transceiver's factory default data for backup. (p. 9-7)

NOTE:

- Before using the microSD card, thoroughly read the card's instructions.
- If you do any of the following, the card data may be corrupted or deleted.
 - You remove the card from the transceiver while the card is being accessed.
 - A power failure occurs, or the power cable (Mobile type) or battery pack (Portable type) is disconnected while the card is being accessed.
 - You drop, impact or vibrate the card.
- Do not touch the contacts of the card.
- The transceiver takes a longer time to recognize a high capacity card.
- The card will get warm if continuously used for a long period of time.
- The card has a certain lifetime, so data reading or writing may not be possible after using it for a long period of time. When reading or writing data is impossible, the card's lifetime has ended. In that case, use a new one. We recommend you make a separate backup file of the important data onto your PC. (p. 9-7)
- Icom will not be responsible for any damage caused by data corruption on a card.

Saving data onto the microSD card

A user can save the following data onto the microSD card:

- Communication audio
The transmitted and received audio.
- Data settings of the transceiver
Memory channel contents saved in the optional programming software.
- Firmware files
The firmware files to update the transceiver's firmware.
- Voice audio of an Emergency

Inserting or removing the microSD card

NOTE: Use the transceiver's built-in Format function to format all microSD cards to be used with the transceiver. Format, even preformatted cards for PCs or other uses. (p. 9-4)

◇ Inserting

● Portable types

Insert the card into the slot until it locks in place, until it makes a 'click' sound.

- The SD card icon is displayed when the microSD card is inserted.

① Be sure to check the card orientation.

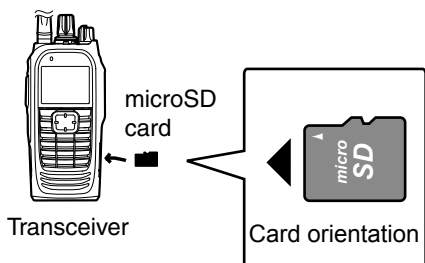

◇ Removing

● Portable types

Push in the microSD card until a click sounds.

- The card is unlocked, and you can pull it out.

① Before you remove the microSD card while the transceiver's power is ON, be sure to first unmount it. (p. 9-4)

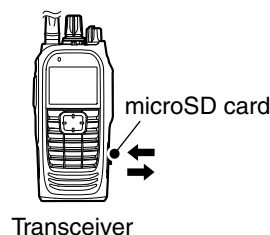

● Mobile types

1. Turn OFF the transceiver.
2. Turn the transceiver upside down.
3. Push the locking tab using a solid tool, such as a flat-bladed screwdriver (①), then detach the front panel (②).

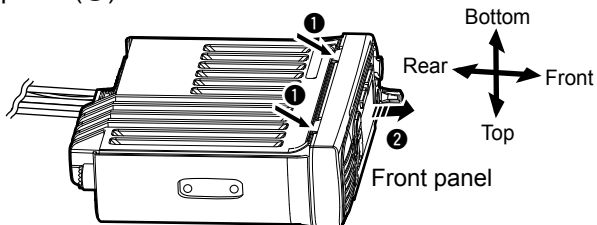

● Mobile types

1. Detach the front panel, as described to the left.
2. Push in the microSD card until it makes a click sound.

- The card is unlocked, and you can pull it out.

① Before you remove the microSD card while the transceiver's power is ON, be sure to first unmount it. (p. 9-4)

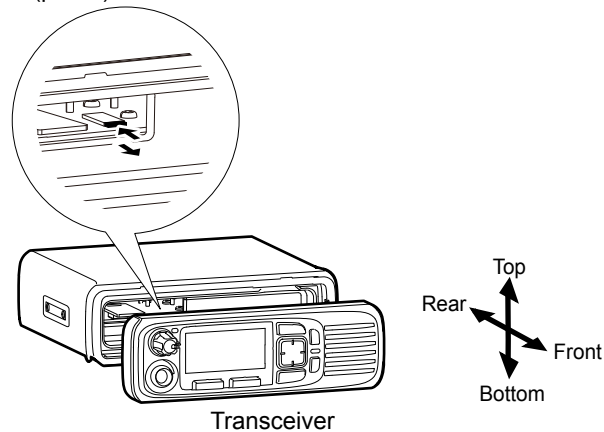

4. Turn the transceiver right-side up.
5. Insert the card into the slot until it locks in place, and makes a 'click' sound.
 - The SD card icon is displayed when the microSD card is inserted.

① Be sure to check the card orientation.

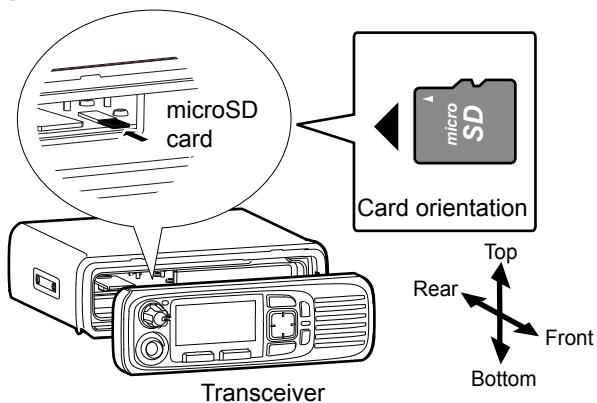

6. Attach the front panel, then turn ON the transceiver.

Unmounting the microSD card

Before you remove a card when the transceiver is ON, be sure to first electrically unmount it, as shown below. Otherwise the data may be corrupted or deleted.

<Menu operation>

(Menu > SD Card > **SD Unmount**)

1. Push [Menu] to display the Menu screen.
2. Push [Left] or [Right] to select "SD Card," then push [OK].



3. Push [Up] or [Down] to select "SD Unmount," then push [OK].
 - "Are you sure?" is displayed.

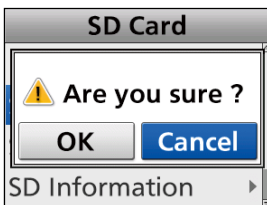
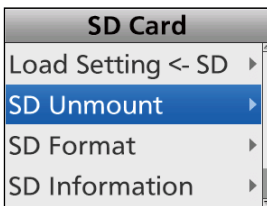

4. Push [Left] or [Right] to select <OK>, then push [OK].
 - ① To cancel unmounting, select <Cancel>.
 - After unmounting, returns to the "SD Card" screen.
5. Hold down [Back] for 1 second to return to the standby screen.
6. Remove the card from the transceiver.

Formatting the microSD card

Use the transceiver's built-in Format function to format all microSD cards to be used with the transceiver. This creates a special folder on the card that you need for operations like loading the data. Format all cards, including a brand new microSD card, and even preformatted cards for PCs or other uses.

NOTE: Formatting a card deletes all its data. Before formatting any used card, back up its data onto your PC. (p. 9-7)

IMPORTANT: Even if you format the microSD card, some data may remain in the card. When you dispose the card, be sure to physically destroy it to avoid unauthorized access to any data that remains.

<Menu operation>

(Menu > SD Card > **SD Format**)

1. Push [Menu] to display the Menu screen.
2. Push [Left] or [Right] to select "SD Card," then push [OK].

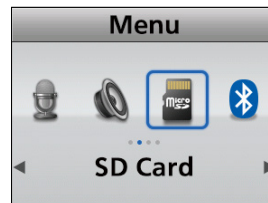

3. Push [Up] or [Down] to select "SD Format," then push [OK].
 - "Are you sure?" is displayed.

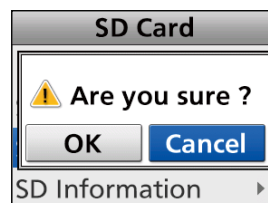
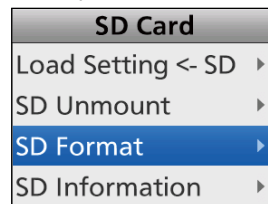

4. Push [Left] or [Right] to select <OK>, then push [OK].
 - ① To cancel formatting, select <Cancel>.
 - After formatting, returns to the "SD Card" screen.
5. Hold down [Back] for 1 second to return to the standby screen.

Loading the saved data files onto a microSD card

You can load the Memory channels and transceiver's settings from the card to a transceiver.

This function is convenient when:

- Setting up from a PC
- Copying the data to another transceiver to operate with the same data.

NOTE: When 2 or more data files are saved in the card, the latest file will be loaded.

TIP: Backing up the current data is recommended before loading other data into the transceiver.
(p. 9-7)

<Menu operation>

(Menu > SD Card > **Load Setting <- SD**)

1. Push [Menu] to display the Menu screen.
2. Push [Left] or [Right] to select "SD Card," then push [OK].

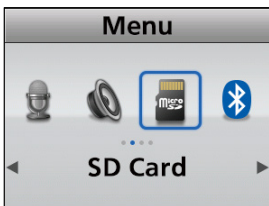

3. Push [Up] or [Down] to select "Load Setting <- SD," then push [OK].
 - "Update Ready Execute?" is displayed.

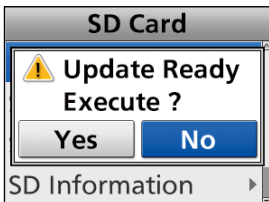
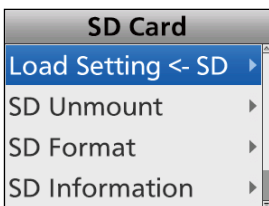

4. Push [Left] or [Right] to select "Yes," then push [OK].
 - Starts the file check.
 - ① While checking the file, "Pre Processing.." and a progress bar are displayed.

5. After checking, the file loading starts.
 - While loading, "Load Setting.." and a progress bar are displayed.
6. After loading ends, the transceiver automatically restarts.

Displaying the information of the microSD card

You can display the microSD card capacity, remaining capacity, and the time remaining for voice recording.

<Menu operation>

(Menu > SD Card > **SD Information**)

1. Push [Menu] to display the Menu screen.
2. Push [Left] or [Right] to select "SD Card," then push [OK].

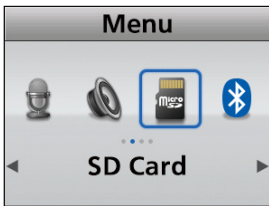

3. Push [Up] or [Down] to select "SD Information," then push [OK].
 - The remaining capacity is displayed.

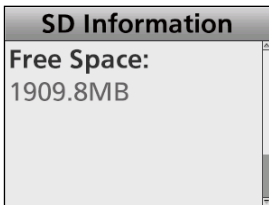
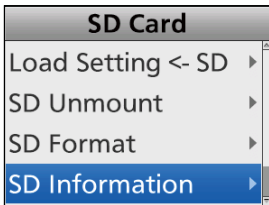

4. Push [Up] or [Down] to select the next screen to display the time remaining for voice recording or the card capacity.

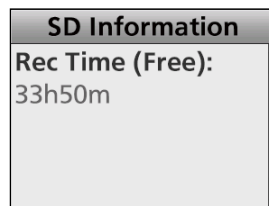

Time remaining for voice recording

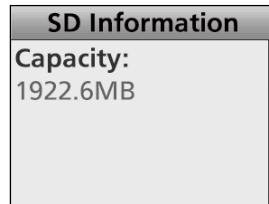

Card capacity

5. Hold down [Back] for 1 second to return to the standby screen.

Backing up the data saved on the microSD card onto a PC

You can easily restore data with a backup file, even if the setting data in the microSD card is accidentally deleted.

◆ About the microSD card's folder contents

The folder in the microSD card contains the following:

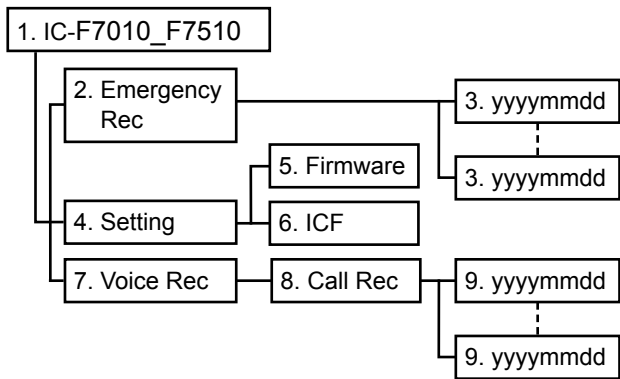

1. IC-F7010_F7510 folder
The folders created in the transceiver by the Format function are contained in this folder.
2. Emergency Rec folder
The recorded Emergency audio dated folders are created.
3. The dated (yyyyymmdd) folders
The recorded Emergency audio files are saved in the 'wav' format.
The folder name is automatically created in the following date format: yyyyymmdd (yyyy:year, mm:month, dd:day)
4. Setting folder
The Firmware and ICF folders are created.
5. Firmware folder
The transceiver's firmware file is saved in the 'mot' format.
6. ICF folder
The transceiver's setting data is saved in the 'icf' format.
7. Voice Rec folder
The Call Rec folder is created.
8. Call Rec folder
The recorded QSO audio date folders are created.
9. The dated (yyyyymmdd) folders
Recorded audio files are saved in the 'wav' format.
The folder name is automatically created in the following date format: yyyyymmdd (yyyy:year, mm:month, dd:day)

(Example: Selecting the setting data)
When the PC reads the microSD card data, the screens shown below are displayed.

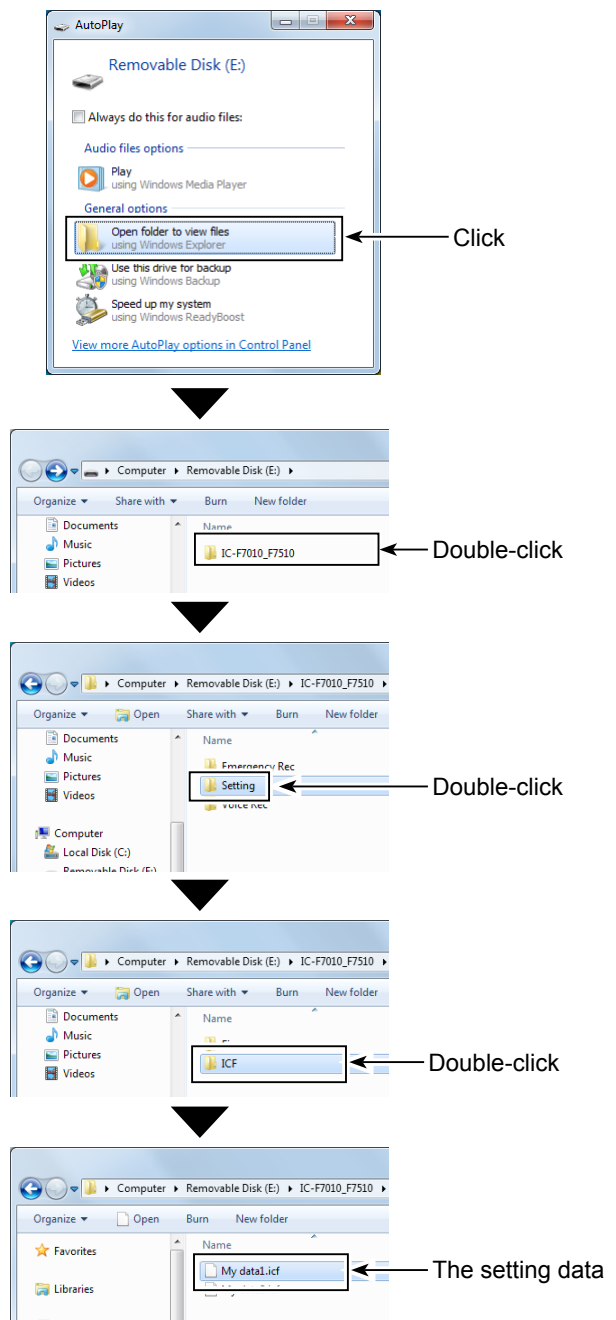

Backing up the data saved on the microSD card onto a PC (Continued)

◇ Making a backup file on your PC

Windows 7 is used for these instructions.

1. Insert the microSD card into the SD card drive or a memory card reader* on your PC.
Or, connect the transceiver and PC using a USB cable*, then set the “USB Mode Select” item to “Card Reader.” (Menu > Function > **USB Mode Select**)
*User supplied.
2. The “AutoPlay” screen is displayed, as shown to the right.
Click “Open folder to view files.”
• Displays the IC-F7010_F7510 folder.

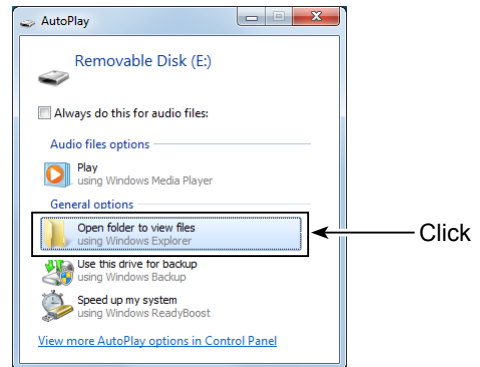

3. Right-click “Removable Disk,” and then click “Copy.”

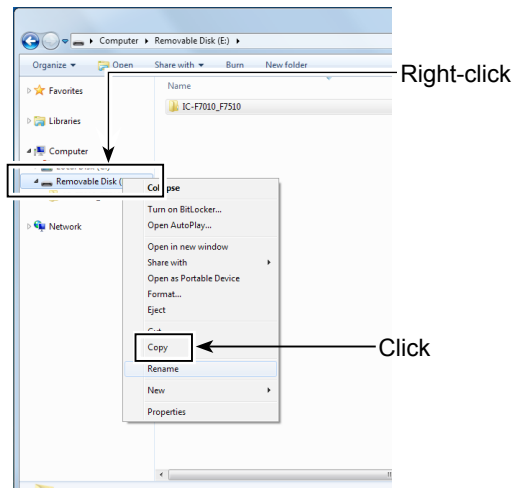

4. Open the desired folder to make a backup file, and then, right-click on the folder.
Then, click “Paste.”
• Pastes the copied microSD card data into the folder.
(Example: Pasting into the “Backup” folder in the C drive)

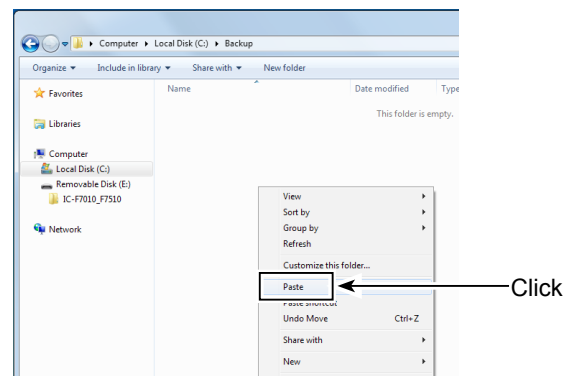

5. When removing the microSD card from your PC, be sure to safely remove it.
①The screen shot shows when a memory card reader is inserted.

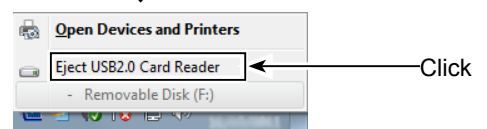

6. After “Safe To Remove Hardware” is displayed, remove the microSD card from your PC.

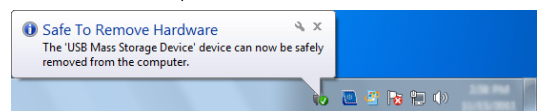

Section 10 VOICE RECORDER FUNCTIONS

Recording a communication audio	10-2
◇ Recording	10-2
Playing back a recorded audio	10-4
◇ Playing back a recorded communication audio	10-4
◇ Player screen	10-5
Deleting a file	10-6
Playing back the recorded file on a PC	10-7

Recording a communication audio

This transceiver is equipped with a recorder not only for the receive audio, but also for transmit audio. This function is useful to make a communication record. The recorded audio is saved onto a microSD card. You can start recording by the key operation or the menu operation.

NOTE:

- To record a communication audio, a microSD card (user supplied) is required.
- If your card does not have an "IC-F7010_F7510" folder, back up any data on the microSD card. Then insert it in the transceivers card slot and then format it using the transceiver's built-in format function. See page 9-4 for details.
- Once the recording starts, will continue, after the transceiver is turned OFF and ON again.
- The recording will continue until you turn OFF the function, or there is no more free space on the microSD card. Depending on the presetting, if there is no more free space on the microSD card, the transceiver automatically deletes the files in the oldest folder to continue the recording.
- When the recording time exceeds 10 minutes, the transceiver continues to record, but it records to a new file.
- You can display the microSD card capacity, remaining capacity, and the time remaining for voice recording. See page 9-6 for details.

◇ Recording

<Key operation>

1. Push [Call Recorder] to turn ON the Call Recorder function.



- "☎" is displayed.
2. Push [PTT] to start recording.
 - "☎" blinks while recording.
 - ① The recording is performed when the mute is released.
 3. Push [Rec Call] again to turn OFF the Call Recorder function.



- "☎" disappears.

TIP: About recording

- When the recording starts, a folder and file are automatically created on the microSD card.
 - ① The folder name is date formatted yyyyymmdd (yyyy: year, mm: month, dd: day).
 - ① The file name is date formatted yyyyymmdd_hhmmss (yyyy: year, mm: month, dd: day, hh: hour, mm: minute, ss: second).
 - ① The audio files recorded on the same day are saved in the same folder.
- While recording, "☎" blinks.
- While standing by, the recording pauses.
- While pausing, "☎" stops blinking.
- "⚠" is displayed when the microSD card has no free space and cannot record additional audio.

Recording a communication audio

◇ Recording (Continued)

<Menu operation>

(Menu > Voice Rec > **Call Recorder**)

1. Push [Menu] to display the Menu screen.
2. Push [Left] or [Right] to select "Voice Rec," then push [OK].

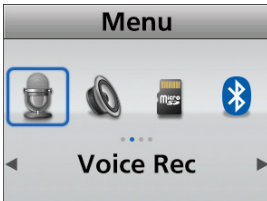

3. Push [Up] or [Down] to select "Call Recorder," then push [OK].

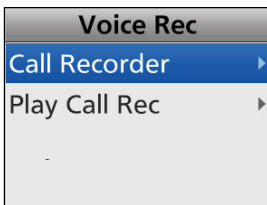

- The "Call Recorder" screen is displayed.
- "Rec Start" is displayed in the screen.

4. Push [OK] to turn ON the Call Recorder function.

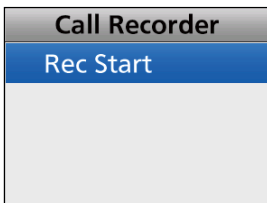

- Automatically returns to the standby screen.
 - "☐" is displayed.
5. Push [PTT] to start recording.
 - "☐" blinks while recording.
 - ① The recording is performed when the mute is released.
 6. Do steps 1 ~ 3 to display the "Call Recorder" screen.
 - ① While recording, "Rec Stop" is displayed in the screen.



7. Push [OK] to turn OFF the Call Recorder function.
 - Automatically returns to the standby screen.
 - "☐" disappears.

Playing back a recorded audio

◇ Playing back a recorded communication audio

You can playback the recorded communication audio.

<Key operation>

1. Push [Play Call].
 - The folder list is displayed.
2. Push [Up] or [Down] to select a folder that contains the file you want to playback, then push [OK].

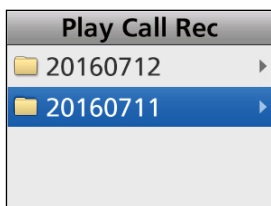

- The file list is displayed.
3. Push [Up] or [Down] to select a file, then push [OK].

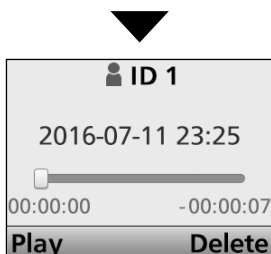
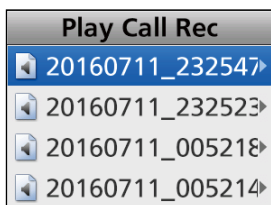

- The player screen is displayed.
 - ① You can select a previous or later file by pushing [Up] or [Down].
4. Push [Play] to start a playback.

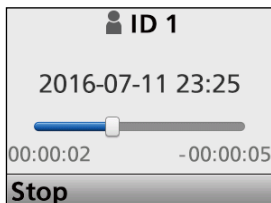

While playing back

- ① See page 10-5 for details of the operation while playing back.
5. Hold down [Back] for 1 second to return to the standby screen.

<Menu operation>

(Menu > Voice Rec > **Play Call Rec**)

1. Push [Menu] to display the Menu screen.
2. Push [Left] or [Right] to select "Voice Rec," then push [OK].

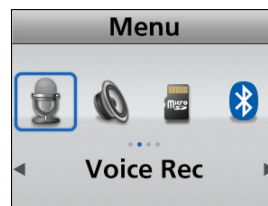

3. Push [Up] or [Down] to select "Play Call Rec," then push [OK].

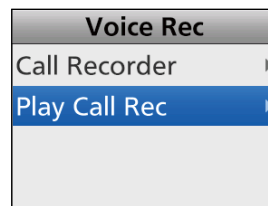

- The folder list is displayed.
4. Push [Up] or [Down] to select a folder that contains the file you want to playback, then push [OK].
 5. Push [Up] or [Down] to select a file, then push [OK].

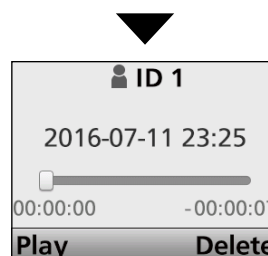
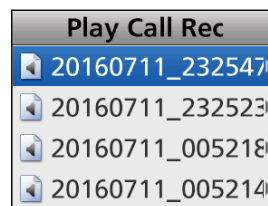

- The player screen is displayed.
 - ① You can select a previous or next file by pushing [Up] or [Down].
6. Push [Play] to start a playback.
 7. Hold down [Back] for 1 second to return to the standby screen.

Playing back a recorded audio (Continued)

◇ Player screen

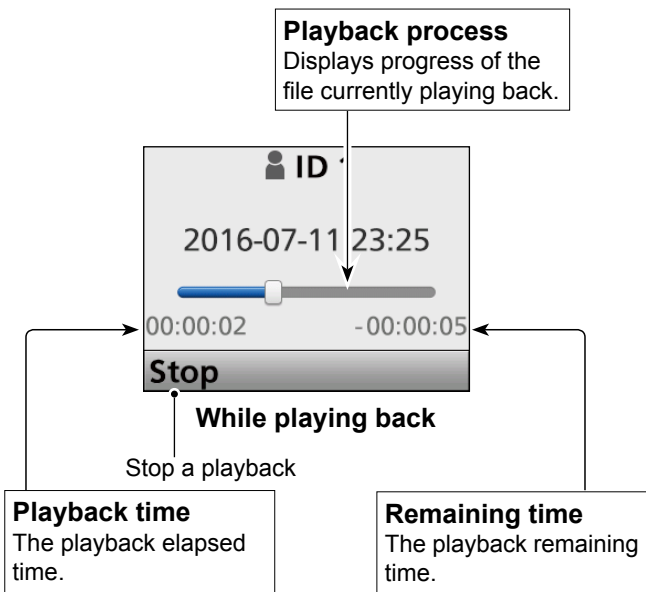
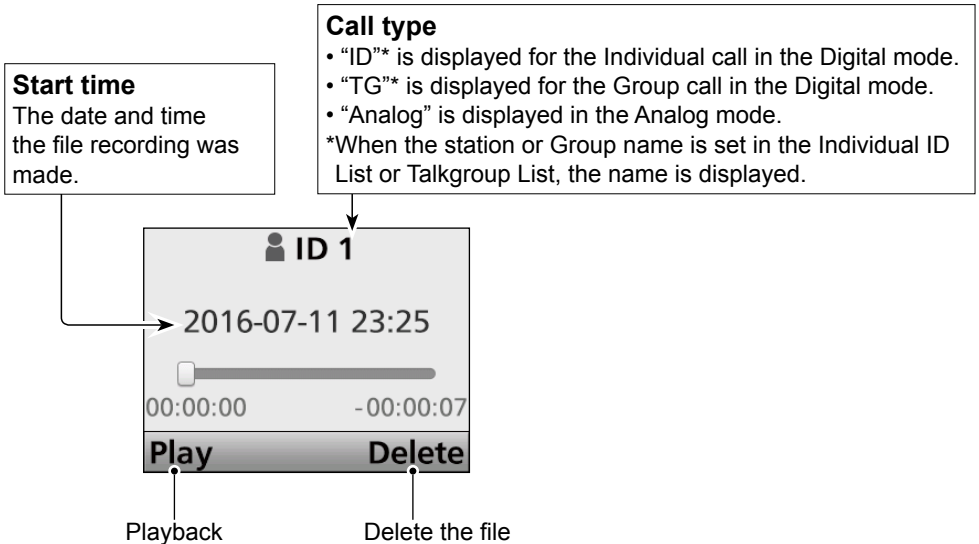

TIP: Operation while playing back

Fast forward while playing back

- Push [Right] to fast forward in 1 second playback steps.
- Hold down [Right] to fast forward in 10 second playback steps until you release [Right].

Rewind while playing back

- Push [Left] to rewind in 1 second playback steps.
- Hold down [Left] to rewind in 10 second playback steps until you release [Left].

Stop the playing
Push [Stop].

Deleting a file

You can delete a recorded audio file.

<Key operation>

1. Push [Play Call].
 - The folder list is displayed.
2. Push [Up] or [Down] to select a folder that contains the file you want to delete, then push [OK].

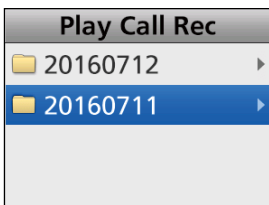

• The file list is displayed.

3. Push [Up] or [Down] to select a file to delete, then push [OK].

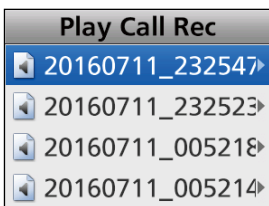

• The player screen is displayed.

4. Push [Delete].

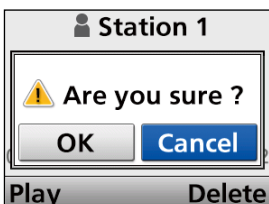
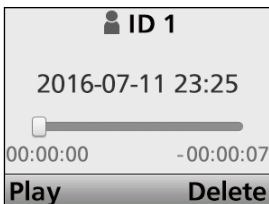

5. Push [Left] or [Right] to select <OK>, then push [OK].
 - The selected file is deleted.
6. Hold down [Back] for 1 second to return to the standby screen.

<Menu operation>

(Menu > Voice Rec > **Play Call Rec**)

1. Push [Menu] to display the Menu screen.
2. Push [Left] or [Right] to select "Voice Rec," then push [OK].

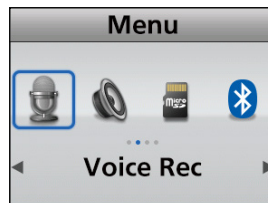

3. Push [Up] or [Down] to select "Play Call Rec," then push [OK].

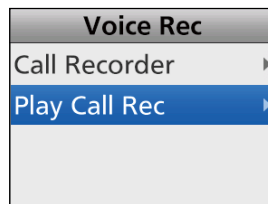

• The folder list is displayed.

4. Push [Up] or [Down] to select a folder that contains the file you want to delete, then push [OK].
 - The file list is displayed.
5. Push [Up] or [Down] to select a file to delete, then push [OK].
 - The player screen is displayed.
6. Push [Delete].

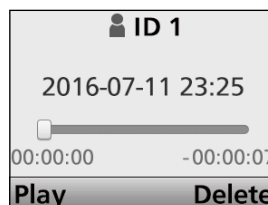

7. Push [Left] or [Right] to select <OK>, then push [OK].
 - The selected file is deleted.
8. Hold down [Back] for 1 second to return to the standby screen.

Playing back the recorded file on a PC

You can also playback the voice memory data on a PC.

① Microsoft® Windows® 7 is used for the description below.

1. Insert the microSD card into the card drive or a memory card reader on your PC.
2. When the microSD card is recognized by the PC, the Auto Play window is displayed, as shown to the right. Click “Open folder to view files.”
 - The “IC-F7010_F7510” folder is displayed.

NOTE:

- The playback method may differ, depending on the application. Refer to the application’s instruction manual for details.
- If the file does not playback, even if you double click the file, download an appropriate application. (Example: Windows Media® Player)

3. Double-click the “IC-F7010_F7510” folder.

4. Double-click the “Voice Rec” folder.

5. Double-click the “Call Rec” folder.

6. Double-click the folder where the file you want to playback is saved.
(Example: 20170705 folder)

7. To playback the file, double-click it.
(Example: 20170705_070424.wav)

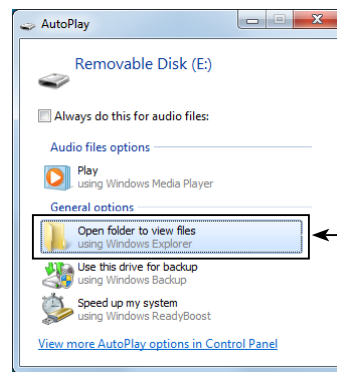

Click

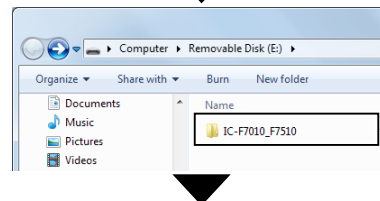

Double-click

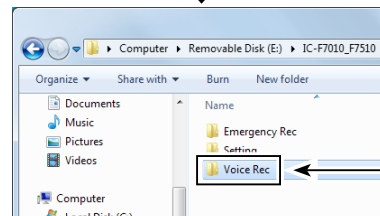

Double-click



Double-click

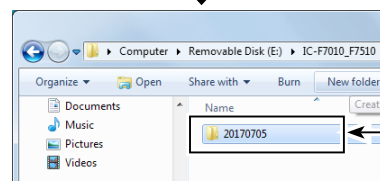

Double-click

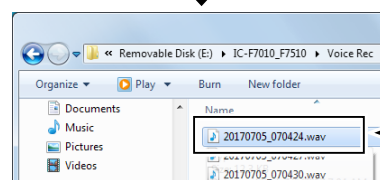

The recorded data

Section 11 Bluetooth® OPERATION

Bluetooth® Wireless Technology operation.....	11-2
◇ Electromagnetic Interference.....	11-2
Turning ON the Bluetooth® function	11-3
Pairing with a headset	11-4
Headset settings.....	11-6
◇ AF Output (Menu > Bluetooth > BT Audio Setting).....	11-6
◇ About the VS-3 headset.....	11-6
Pairing with a data device.....	11-7
Accepting a pairing request from a Bluetooth® device	11-9
Disconnecting from a Bluetooth® device	11-11
Deleting a Bluetooth® device from the pairing list.....	11-12
Resetting the installed Bluetooth® unit	11-13
The maximum number of paired devices	11-14

Bluetooth® Wireless Technology operation

You can connect to other Bluetooth wireless technology enabled devices (Headset or Data) with the installed Bluetooth unit.

• **Icom Headset**

When you connect the optional VS-3 Bluetooth HEADSET to the transceiver, you can wirelessly transmit and receive the headset audio. The VS-3 has a [PTT] switch, so you can transmit in the same way as using the transceiver's [PTT] switch. The VOX function can also be used, so you can toggle transmit and receive by your voice through the headset microphone. You can assign a desired key function to the keys on the side panel of the VS-3 to remotely operate the transceiver.

• **Third party Headset**

When you connect a third party's Bluetooth headset to the transceiver, you can wirelessly transmit and receive the audio.

• **PC with Bluetooth**

When you connect a PC with Bluetooth to a transceiver, you can set it up using the optional programming software.

The communication range of Bluetooth is approximately 10 meters (33 feet).

◇ **Electromagnetic Interference**

The Bluetooth communication range may vary, depending on the environment in which the device operates. When you use a Bluetooth device, pay attention to the following:
 Bluetooth devices operate in the 2.4 GHz band. The 2.4 GHz band is also used by other devices, such as Wireless LAN products, microwave ovens, RFID systems, amateur radio stations, and so on. When using this device near such devices, interference may occur, causing a decrease in communication speed, and an unstable connection. In such cases, use this device away from the other devices, or stop using those devices.

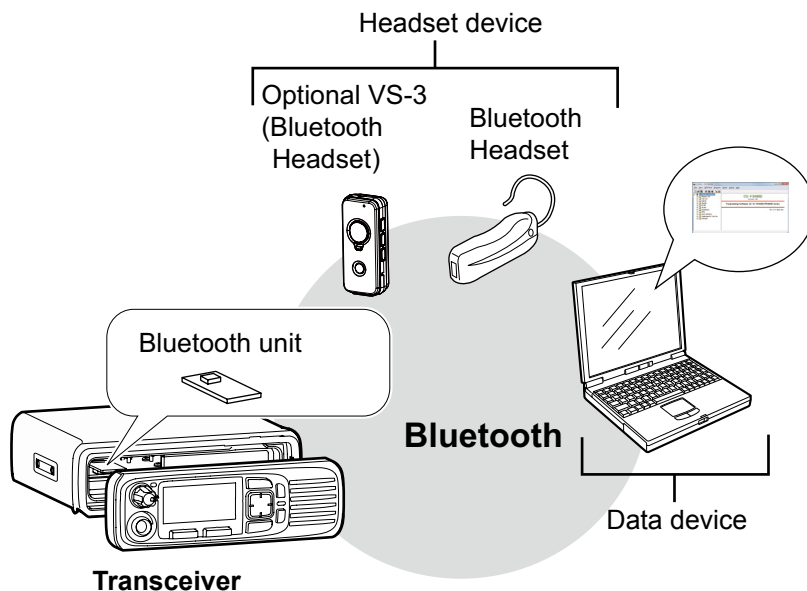

Turning ON the Bluetooth® function

(Menu > Bluetooth > Bluetooth)

1. Push [Menu] to display the “Menu” screen.
2. Push [Left] or [Right] to select “Bluetooth,” then push [OK].



3. Push [Up] or [Down] to select “Bluetooth,” then push [OK].



4. Push [Up] or [Down] to select “ON,” then push [OK].
 - The Bluetooth function is turned ON.

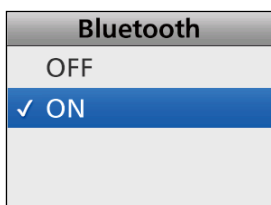

5. Hold down [Back] for 1 second to return to the standby screen.

TIP: You can also turn the Bluetooth function ON or OFF by pushing [Bluetooth].

Pairing with a headset

Step 1: Entering the Pairing mode (Headset)

① See the Bluetooth device's instruction manual for details.

Step 2: Turning ON the Bluetooth function (Transceiver)

① See page 11-3 for details.

Step 3: Searching for the headset (Transceiver)

1. Push [Menu] to display the "Menu" screen.
2. Push [Left] or [Right] to select "Bluetooth," then push [OK].



3. Push [Up] or [Down] to select "BT Device List," then push [OK].



4. Push [Up] or [Down] to select "Find Device," then push [OK].

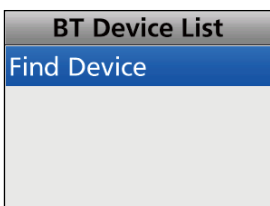

TIP: If the transceiver has been connected to the Bluetooth headset before, its name may be displayed in step 4 on the next page. In that case, push [Up] or [Down] to select it, then push [OK] to connect.

5. Push [Up] or [Down] to select "Headset," then push [OK] to start searching.

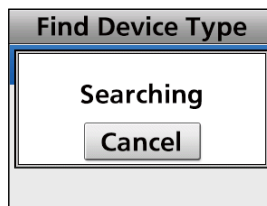
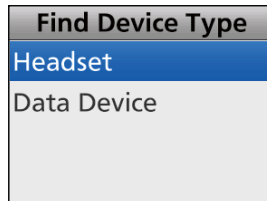

6. When pairable headsets are found, their names are displayed on the screen.

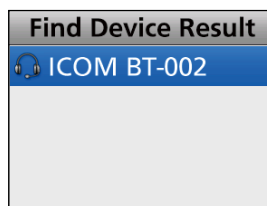

TIP: If the transceiver cannot find any pairable devices, the following screen is displayed. In that case, do step 4 on the next page to search for a device again.

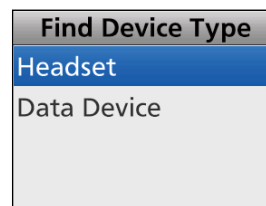

☞ Continued on the next page.

Pairing with a headset (Continued)

Step 4: Connecting to the headset (Transceiver)

1. Push [Up] or [Down] to select the headset to connect, then push [OK].
 - Connects to the headset.

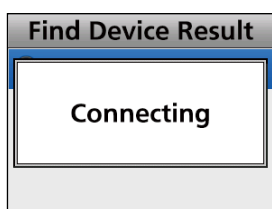
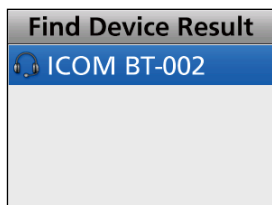

- After the transceiver and the headset connection has succeeded, "✓" is displayed beside the device icon.

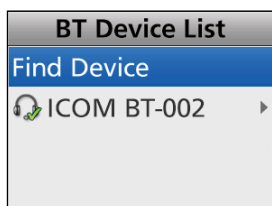

2. Hold down [Back] for 1 second to return to the standby screen.
 - While connected to a headset, "Bluetooth" is displayed instead of "Bluetooth".

NOTE: The transceiver connects to the last connected device, if the connecting operation is performed on the device side, even if the "Auto Connect" item is set to OFF.

TIP: When you turn ON the transceiver, with the "Auto Connect" item is set to ON, the transceiver automatically connects to the last paired device. After connecting, "Bluetooth" is displayed instead of "Bluetooth".

Headset settings

◇ AF Output

(Menu > Bluetooth > **BT Audio Setting**)

You can set the audio output device when a Bluetooth headset is connected.

If the “BT Audio Setting” item is set to “BT & SP,” you can hear audio from both a connected Bluetooth headset and the transceiver’s speaker.

See page 6-16 for details.

◇ About the VS-3 headset

You can set the detailed settings of the optional VS-3 Bluetooth HEADSET.

- **Key Beep** (p. 6-16)

(Menu > Bluetooth > **Key Beep (VS-3)**)

Set a beep to sound when you push [PLAY], [FWD] or [RWD] on the VS-3. This setting is different from the transceiver’s beep setting. When both settings are set to “ON,” the beeps sound on the transceiver and on the headset.

- **Power Save** (p. 6-16)

(Menu > Bluetooth > **P.Save (VS-3)**)

The Power Save function temporarily disconnects the Bluetooth connection if no communication or operation is performed for 120 seconds, to prolong the VS-3’s battery life.

- **PTT Beep** (p. 6-16)

(Menu > Bluetooth > **PTT Beep (VS-3)**)

Set a beep to sound when you push [PTT] on the VS-3. This setting is different from the transceiver’s beep setting. When both settings are set to “ON,” the beeps sound on the transceiver and on the headset.

- **One-touch PTT** (p. 6-16)

(Menu > Bluetooth > **One-touch PTT**)

The One-Touch PTT function enables you to toggle between transmit and receive by pushing [PTT].

Pairing with a data device

Step 1: Entering the Pairing mode (Data device)

① See the data device's instruction manual for details.

Step 2: Turning ON the Bluetooth function (Transceiver)

① See page 11-3 for details.

Step 3: Searching for the data device (Transceiver)

1. Push [Menu] to display the "Menu" screen.
2. Push [Left] or [Right] to select "Bluetooth," then push [OK].



3. Push [Up] or [Down] to select "BT Device List," then push [OK].



4. Push [Up] or [Down] to select "Find Device," then push [OK].

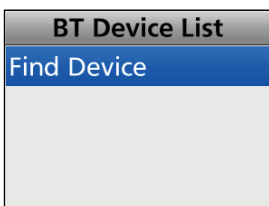

① If the transceiver has been connected to the Bluetooth device before, its name may be displayed.

5. Push [Up] or [Down] to select "Data Device," then push [OK] to start searching.

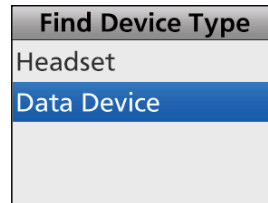

6. When pairable devices are found, their names are displayed on the screen.

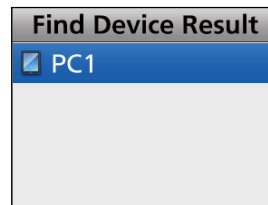

TIP: If the transceiver cannot find any pairable device, the following screen is displayed. In that case, do step 4 to search for a device again.

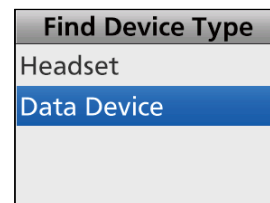

Continued on the next page.

Pairing with a data device (Continued)

Step 4: Connecting to the data device (Transceiver)

Push [Up] or [Down] to select the data device to connect, then push [OK].

- Connects to the data device.

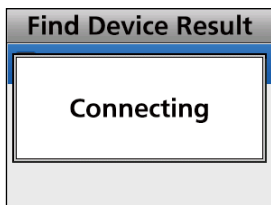
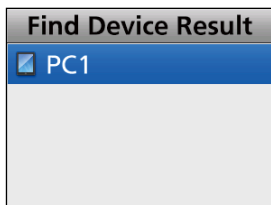

Step 5: Setting the Bluetooth Serial Port (Data device)

If the Serial Port Access Authorization screen as shown below is displayed, accept it.

- ① The content of screen may differ, depending on the device.
- ① See the device's instruction manual for details.



(Example)

Step 6: Connection (Transceiver)

1. After the transceiver and the device connection has succeeded, "✓" is displayed beside the device's icon.

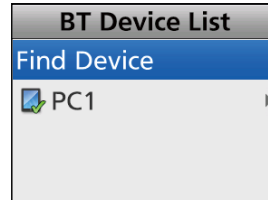

2. Hold down [Back] for 1 second to return to the standby screen.
 - While connected to a Bluetooth device, "📶" is displayed instead of "📶".

TIP: When you turn ON the transceiver, with the "Auto Connect" item is set to ON, the transceiver automatically connects to the last paired device. After connecting, "📶" is displayed instead of "📶".

Accepting a pairing request from a Bluetooth® device

This section describes how to accept a pairing request from a Bluetooth device.

Step 1: Prepare the Bluetooth device

Step 2: Turn ON the Bluetooth function (Transceiver)

① See page 11-3 for details.

Step 3: Enter the Waiting Pairing mode (Transceiver)

1. Push [Menu] to display the "Menu" screen.
2. Push [Left] or [Right] to select "Bluetooth," then push [OK].



3. Push [Up] or [Down] to select "Waiting Pairing," then push [OK].
 - Enters the Waiting Pairing mode.

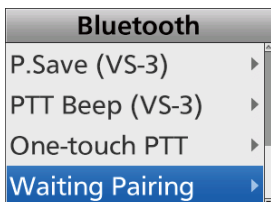

TIP: You can enter the Waiting Pairing mode by pushing [Waiting Pairing].

Step 4: Enter the Pairing mode (Bluetooth device)

① See the device's instruction manual for details.

Step 5: Send a Pairing request to the transceiver (Bluetooth device)

1. The device displays the transceiver's Bluetooth unit name on the screen.
2. Select the displayed name to send a pairing request.
 - The Bluetooth device sends a pairing request.
 - ① See the device's instruction manual for details.
 - ① You can confirm the transceiver's Bluetooth unit name on the "BT Device Info" screen. (p. 6-16)

Step 6: Receive a Pairing Request (Transceiver)

1. "Passkey? MMMMM" is displayed on the transceiver.
2. Confirm the displayed passkey is the same as yours.
3. Push [Left] or [Right] to select <Accept>, then push [OK].
 - Pairing starts.



4. After the pairing is complete, the device's name is displayed in the "BT Device List" screen.

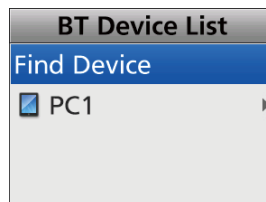

5. Push [Up] or [Down] to select the Bluetooth device to connect, then push [OK].

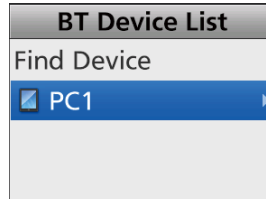

Accepting a pairing request from a Bluetooth® device (Continued)

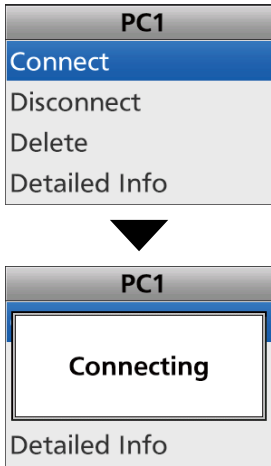

6. Push [Up] or [Down] to select “Connect,” then push [OK].
 - Connects to the device.

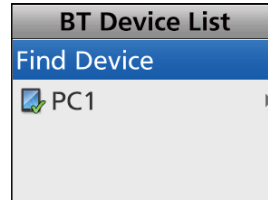

Step 8: Connection (Transceiver)

1. After the transceiver and the device connection has succeeded, “✓” is displayed beside the device icon.



2. Hold down [Back] for 1 second to return to the standby screen.
 - “” is displayed instead of “.

NOTE: When you pair with the third party's headset, entering a PIN code or passkey may be required. See the headset's instruction manual for details.

Step 7: Set the Bluetooth Serial Port (Bluetooth device)

If the Serial Port Access Authorization screen as shown below is displayed, accept it.

- ① The content of screen may differ, depending on the device.
- ② See the device's instruction manual for details.



(Example)

Disconnecting from a Bluetooth® device

You can disconnect from a Bluetooth device without cancelling the pairing.

(Menu > Bluetooth > **BT Device List**)

1. Push [Menu] to display the “Menu” screen.
2. Push [Left] or [Right] to select “Bluetooth,” then push [OK].



3. Push [Up] or [Down] to select “BT Device List,” then push [OK].



4. Push [Up] or [Down] to select the Bluetooth device that is currently connected, then push [OK].

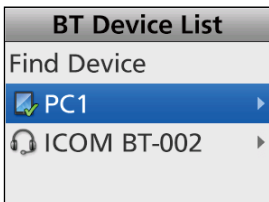

5. Push [Up] or [Down] to select “Disconnect,” then push [OK].

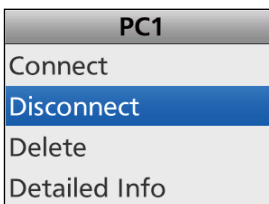

6. The transceiver disconnects from the Bluetooth device, and “✓” disappears beside the device’s icon.

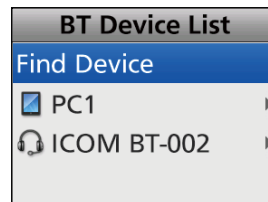

① The transceiver is still paired with the Bluetooth device.

TIP: You can reconnect to the Bluetooth device displayed on the screen again by doing the following steps.

1. Push [Up] or [Down] to select the Bluetooth device to connect, then push [OK].

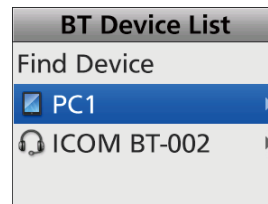

2. Push [Up] or [Down] to select “Connect,” then push [OK].

- Connects to the device.

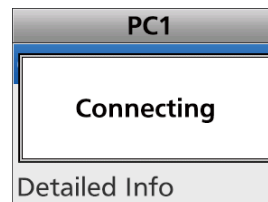
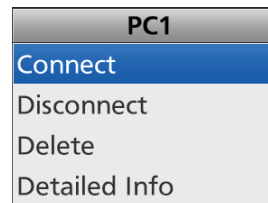

3. Do steps 7 (“Set the Bluetooth Serial Port”) and 8 (“Connection”) on page 11-10 to connect.
 - After the connection is successful, the display returns to the standby screen.

Deleting a Bluetooth® device from the pairing list

You can delete a Bluetooth device from the “BT Device List” screen. Before deleting a connected Bluetooth device, you must disconnect it. (p. 11-11)

TIP: If you want to reconnect the deleted device, you must first pair with it again. (p. 11-7, 11-9)

(Menu > Bluetooth > **BT Device List**)

1. Push [Menu] to display the “Menu” screen.
2. Push [Left] or [Right] to select “Bluetooth,” then push [OK].



3. Push [Up] or [Down] to select “BT Device List,” then push [OK].



4. Push [Up] or [Down] to select the Bluetooth device that is currently unconnected, then push [OK].

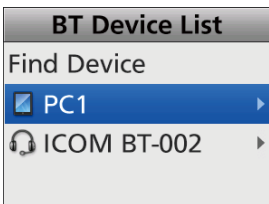

5. Push [Up] or [Down] to select “Delete,” then push [OK].

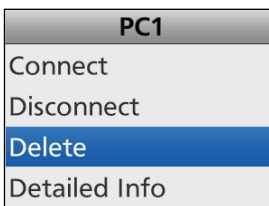

6. The Bluetooth device is deleted from the list.

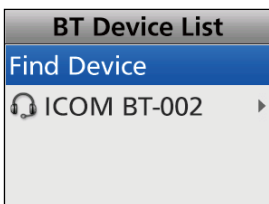

Resetting the installed Bluetooth® unit

You can reset the installed Bluetooth unit. You should reset the unit if you have trouble during Bluetooth operation.

NOTE: Before resetting, the Bluetooth function must be turned OFF. Otherwise, resetting cannot be done.

(Menu > Bluetooth > **Bluetooth Reset**)

1. Push [Menu] to display the “Menu” screen.
2. Push [Left] or [Right] to select “Bluetooth,” then push [OK].

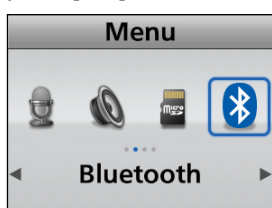

3. Push [Up] or [Down] to select “Bluetooth Reset,” then push [OK].

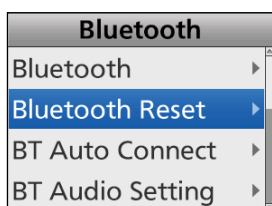

4. Push [Left] or [Right] to select <Yes>, then push [OK].



- Resets the Bluetooth unit's settings to their factory defaults.
5. Hold down [Back] for 1 second to return to the standby screen.

The maximum number of paired devices

You can pair two types of the Bluetooth devices:
Headset and Data devices.

Up to 8 Bluetooth devices can be paired.

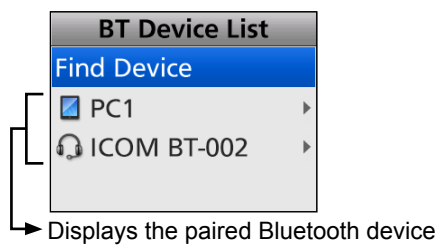

Section 12 USER SETTINGS

Setting the Backlight status	12-2
Setting the Key-touch Beep level	12-3
Setting the Ringer level	12-4
Setting the Squelch level	12-5
Setting the Microphone gain level	12-6
Setting the VOX function	12-7
Setting the VOX Delay.....	12-8
Setting the VOX gain level.....	12-9
Setting the TX Noise Cancel level	12-10
Setting the RX Noise Cancel level.....	12-11

Setting the Backlight status

You can set the Backlight status.

<Menu operation>

(Menu > Display > **Backlight**)

1. Push [Menu] to display the Menu screen.
2. Push [Left] or [Right] to select "Display," then push [OK].



3. Push [Up] or [Down] to select "Backlight," then push [OK].

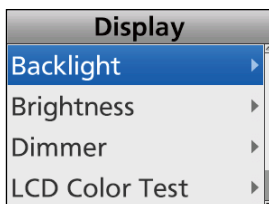

4. Push [Up] or [Down] to select an appropriate option, then push [OK].

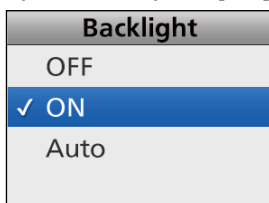

For the Portable types:

- OFF: Turns the Backlight continuously OFF.
- ON: Turns the Backlight continuously ON.
- Auto: When any key except [PTT] is pushed, the Backlight lights for 5 seconds.

For the Mobile types:

- OFF: Turns the Backlight continuously OFF.
- ON: Turns the Backlight continuously ON.
- Auto: Turns the Backlight continuously ON.
When the Dimmer terminal of the D-Sub 25 pin or Option Connector 22 pin is activated, the Backlight lights dimly.

5. Hold down [Back] for 1 second to return to the standby screen.

<Key operation>

Portable:

Push [Backlight] to select the option.

- OFF: Turns the Backlight continuously OFF.
- ON: Turns the Backlight continuously ON.
- Auto: When any key except [PTT] is pushed, the Backlight lights for 5 seconds.

Mobile:

Push [Backlight] to select the option.

- OFF: Turns the Backlight continuously OFF.
- ON: Turns the Backlight continuously ON.
- Auto: Turns the Backlight continuously ON.
When the Dimmer terminal of the D-Sub 25 pin or Option Connector 22 pin is activated, the Backlight lights dimly.

Setting the Key-touch Beep level

You can set the Key-touch Beep level.
A beep sounds when you operate a key.

<Menu operation>

(Menu > Utility > **Key-touch Beep Lv**)

1. Push [Menu] to display the Menu screen.
2. Push [Left] or [Right] to select "Utility," then push [OK].

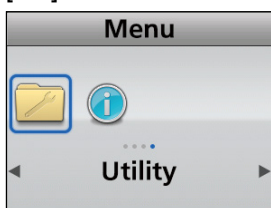

3. Push [Up] or [Down] to select "Key-touch Beep Lv," then push [OK].

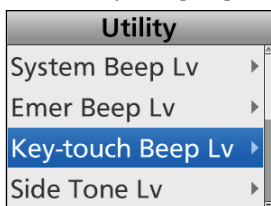

4. Push [Up] or [Down] to set the Key-touch Beep level, then push [OK].

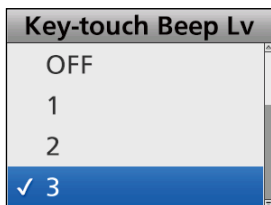

- ① The settable range is 1 ~ 5, 1 (Linked) ~ 5 (Linked) or OFF.
- ① When you select a Linked option, the beep level is adjustable by rotating [VOL].
5. Hold down [Back] for 1 second to return to the standby screen.

Setting the Ringer level

You can set the Ringer level.
Rings sound when receiving a call.

<Menu operation>

(Menu > Utility > **Ringer Lv**)

1. Push [Menu] to display the Menu screen.
2. Push [Left] or [Right] to select "Utility," then push [OK].

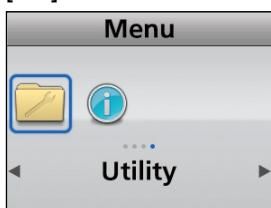

3. Push [Up] or [Down] to select "Ringer Lv," then push [OK].

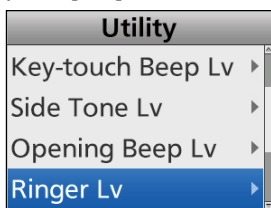

4. Push [Up] or [Down] to set the Ringer level, then push [OK].



- ① The setable range is 1 ~ 5, 1 (Linked) ~ 5 (Linked) or OFF.
 - ① When you select a Linked option, the Ringer level is adjustable by rotating [VOL].
5. Hold down [Back] for 1 second to return to the standby screen.

Setting the Squelch level

You can set the Squelch level to between 1 (loose squelch) and 9 (tight squelch), or 0 (open). The squelch circuit mutes the received audio signal, depending on the signal strength.

<Menu operation>

(Menu > Utility > **SQL Level**)

1. Push [Menu] to display the Menu screen.
2. Push [Left] or [Right] to select "Utility," then push [OK].

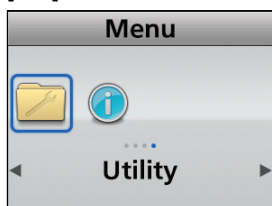

3. Push [Up] or [Down] to select "SQL Level," then push [OK].

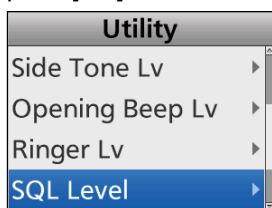

4. Push [Up] or [Down] to set the Squelch level, then push [OK].

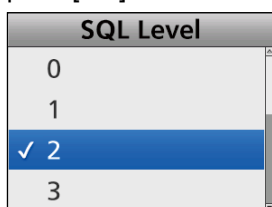

① The settable range is 1 (loose squelch) ~ 9 (tight squelch), or 0 (open).

5. Hold down [Back] for 1 second to return to the standby screen.

Setting the Microphone gain level

<Menu operation>

(Menu > Audio Setting > **Mic Gain**)

1. Push [Menu] to display the Menu screen.
2. Push [Left] or [Right] to select "Audio Setting," then push [OK].



3. Push [Up] or [Down] to select "Mic Gain," then push [OK].

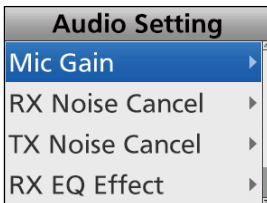

4. Push [Up] or [Down] to set the Microphone gain level, then push [OK].

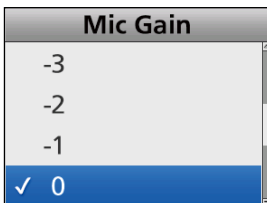

① The settable range is -8 (minimum) ~ +5 (maximum).

5. Hold down [Back] for 1 second to return to the standby screen.

Setting the VOX function

You can turn the VOX function ON or OFF.
The VOX function automatically switches between receive and transmit in the voice mode.

<Menu operation>

(Menu > Functions > **VOX**)

1. Push [Menu] to display the Menu screen.
2. Push [Left] or [Right] to select "Functions," then push [OK].

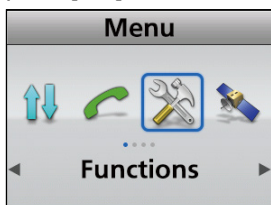

3. Push [Up] or [Down] to select "VOX," then push [OK].

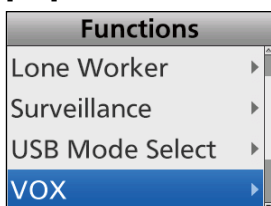

4. Push [Up] or [Down] to turn the VOX function ON or OFF, then push [OK].

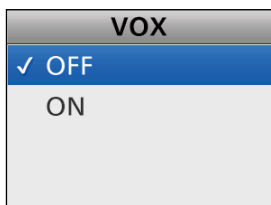

5. Hold down [Back] for 1 second to return to the standby screen.

Setting the VOX Delay

The VOX Delay is the period of time the transceiver continues transmitting after the user stops speaking, and then the VOX switches to receive.

<Menu operation>

(Menu > Functions > **VOX Delay**)

1. Push [Menu] to display the Menu screen.
2. Push [Left] or [Right] to select "Functions," then push [OK].

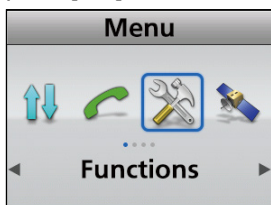

3. Push [Up] or [Down] to select "VOX Delay," then push [OK].

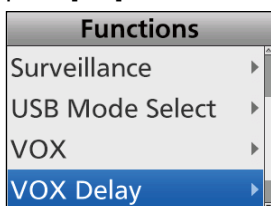

4. Push [Up] or [Down] to set the VOX Delay, then push [OK].

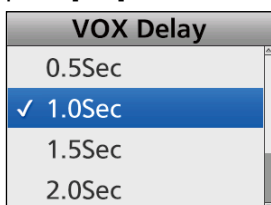

① The setable range is 0.5 ~ 3.0 seconds in 0.5 second steps.

5. Hold down [Back] for 1 second to return to the standby screen.

Setting the VOX gain level

You can set the VOX gain level to between 1 (minimum) and 10 (maximum). Higher values make the VOX function more sensitive to your voice.

<Menu operation>

(Menu > Functions > **VOX Gain**)

1. Push [Menu] to display the Menu screen.
2. Push [Left] or [Right] to select "Functions," then push [OK].

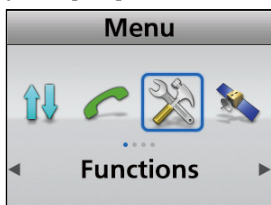

3. Push [Up] or [Down] to select "VOX Gain," then push [OK].

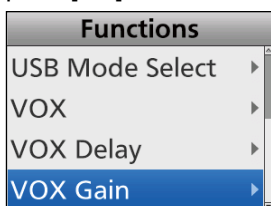

4. Push [Up] or [Down] to set the VOX gain level, then push [OK].

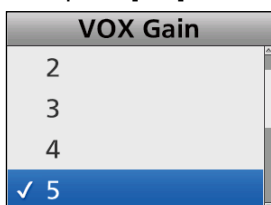

①The setable range is 1 (minimum) ~ 10 (maximum).

5. Hold down [Back] for 1 second to return to the standby screen.

Setting the TX Noise Cancel level

You can set the TX Noise Cancel level to between 1 (minimum) and 3 (maximum), or OFF to suppress the microphone input noise to make the audio easy to hear. Higher values suppress the audio noise more, but the audio quality decreases.

<Menu operation>

(Menu > Audio Setting > **TX Noise Cancel**)

1. Push [Menu] to display the Menu screen.
2. Push [Left] or [Right] to select "Audio Setting," then push [OK].

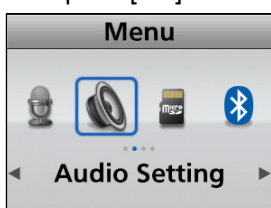

3. Push [Up] or [Down] to select "TX Noise Cancel," then push [OK].

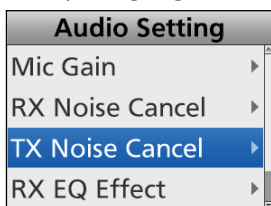

4. Push [Up] or [Down] to set the TX Noise Cancel level.

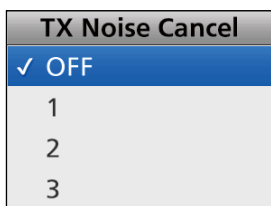

① The settable range is 1 ~ 3, or OFF.

① When "OFF" is selected, the microphone input noise is not suppressed.

5. Hold down [Back] for 1 second to return to the standby screen.

Setting the RX Noise Cancel level

You can set the RX Noise Cancel level to between 1 (minimum) and 3 (maximum), or OFF to suppress the receive audio noise to make the audio easy to hear. Higher values suppress the audio noise more, but the audio quality decreases.

<Menu operation>

(Menu > Audio Setting > **RX Noise Cancel**)

1. Push [Menu] to display the Menu screen.
2. Push [Left] or [Right] to select "Audio Setting," then push [OK].

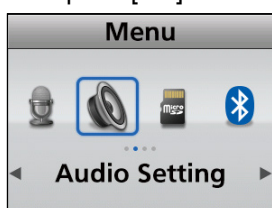

3. Push [Up] or [Down] to select "RX Noise Cancel," then push [OK].

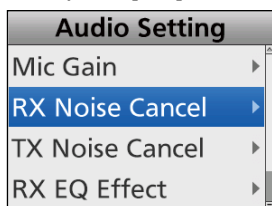

4. Push [Up] or [Down] to set the RX Noise Cancel level.

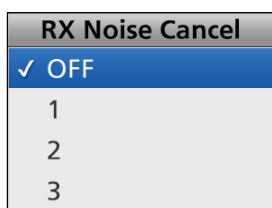

①The setable range is 1 ~ 3, or OFF.

①When "OFF" is selected, the receive audio noise is not suppressed.

5. Hold down [Back] for 1 second to return to the standby screen.

<Key operation>

Push [RX Noise Cancel] to set the RX Noise Cancel level.

①The setable range is 1 ~ 3, or OFF.

①When "OFF" is selected, the receive audio noise is not suppressed.

Section 13 OTHERS

Displaying the transceiver's firmware information	13-2
LCD Color Check.....	13-3
Copying data from a transceiver.....	13-4
◇ Connecting.....	13-4
◇ Copying data.....	13-4

Displaying the transceiver's firmware information

You can display the transceiver firmware's information.

<Menu operation>

(Menu > Information > **Firmware Info**)

1. Push [Menu] to display the Menu screen.
2. Push [Left] or [Right] to select "Information," then push [OK].

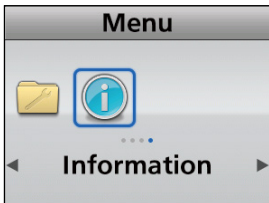

3. Push [Up] or [Down] to select "Firmware Info," then push [OK].

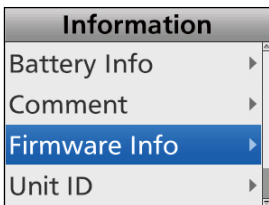

4. Push [Up] or [Down] to display the transceiver's firmware information.
5. Hold down [Back] for 1 second to return to the standby screen.

<Key operation>

1. Turn OFF the transceiver.
2. While holding down [P1] and [OK], turn ON the transceiver.
 - The transceiver enters the Firmware Information mode, and "Firm Info" is displayed on the Key Display area.

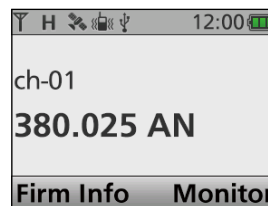

3. Push [P1] to display the "Firmware Info" screen.
4. Push [Up] or [Down] to display the transceiver's firmware information.
5. Turn OFF the transceiver, then turn it ON again to exit the Firmware Information mode.

LCD Color Check

You can check whether or not the LCD displays correctly.

<Menu operation>

(Menu > Display > LCD Color Test)

1. Push [Menu] to display the Menu screen.
2. Push [Left] or [Right] to select "Display," then push [OK].



3. Push [Up] or [Down] to select "LCD Color Test," then push [OK].

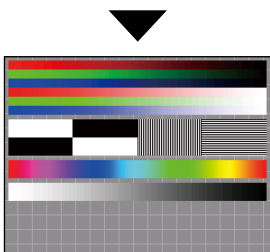
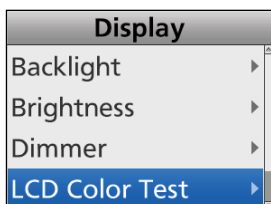

- The transceiver displays the Color Test screen.
4. Hold down [Back] for 1 second to return to the standby screen.

<Key operation>

1. Turn OFF the transceiver.
2. While holding down [P1] and [Back], turn ON the transceiver.
 - The transceiver enters the LCD Color Test mode, and "LCD Test" is displayed on the Key Display area.

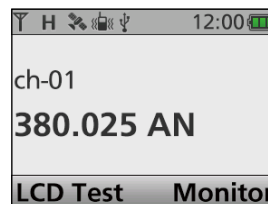

3. Push [P1] to display the color test screen.

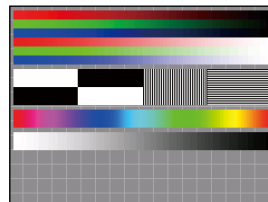

4. Turn OFF the transceiver, then ON again to exit the LCD Color Test mode.

Copying data from a transceiver

This section describes how to copy data from a Master transceiver to a Sub transceiver using the optional OPC-1870 or OPC-2362 ZONE COPY CABLE. The copying procedure differs, depending on the type of the Master transceiver used.

NOTE: Before copying, set the “Transceiver Data Out” item to “ON” using the CS-F7500 PROGRAMMING SOFTWARE.

◇ Connecting

Before copying, connect the Master and Sub transceivers using the optional OPC-1870 or OPC-2362 ZONE COPY CABLE.

1. Turn OFF the Master and Sub transceivers.
2. Connect the two transceivers with the cable. The following cables are used:
 - OPC-1870: Used between a Portable and a Portable.
 - OPC-2362: Used between a Portable and a Mobile.

Portable and Portable connection

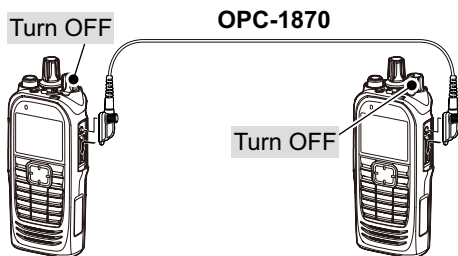

Portable and Mobile connection

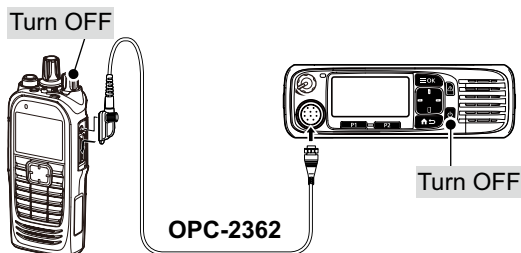

◇ Copying data

Step 1: Enter the Programming mode (Master)

1. While holding down [P1] and [Down], turn ON the transceiver. Continue holding down [P1] and [Down] for about 3 seconds.
 - 2 beeps sound.
2. Push [Up] or [Down] to select “Programming.”
 - The transceiver enters the Programming mode.

Step 2: Turn ON the transceiver (Sub)

Step 3: Copy data (Master)

Push [PTT] (Portable) or Power switch (Mobile) to start copying data to the Sub transceiver.

Step 4: Complete (Master/Sub)

After copying is completed, the Master and Sub transceivers automatically restart.

- The user can operate the Sub transceiver with the loaded data.

Section 14 OPTIONS

HM-222 SPEAKER MICROPHONE	
(for the Portable type transceiver)	14-2
◇ Attaching	14-2
MB-136 BELT CLIP (for the Portable type transceiver)	14-3
◇ MB-136 contents	14-3
◇ Attaching	14-3
◇ Detaching	14-4
LC-184 CARRYING CASE (for the Portable type transceiver) ..	14-5
◇ Types	14-5
◇ Attaching	14-5

HM-222 SPEAKER MICROPHONE (for the Portable type transceiver)

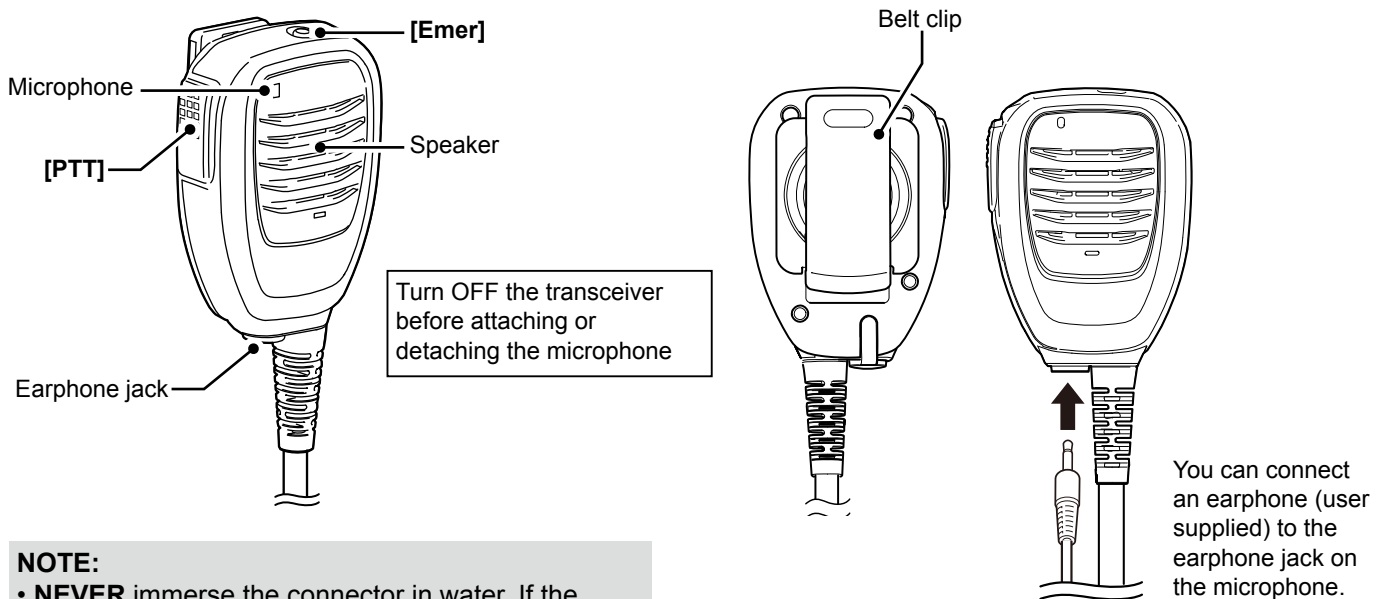

NOTE:

- **NEVER** immerse the connector in water. If the connector becomes wet, be sure to dry it **BEFORE** attaching to the transceiver.
- The microphone element is located at the top left of the speaker microphone, as shown in the illustration above. To maximize the readability of your transmitted audio, hold the microphone approximately 5 to 10 cm (2 to 4 inches) from your mouth, and then speak at your normal voice level.

◇ Attaching

Attach the connector of the speaker microphone to the multi connector on the transceiver and tighten the screw.

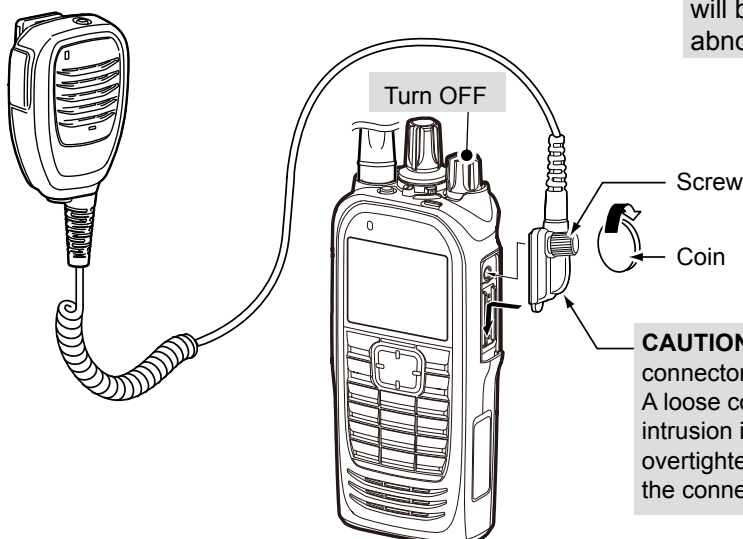

NOTE: KEEP the connector cover attached to the transceiver when the speaker microphone is not in use. Water will not get into the transceiver, even if the cover is not attached. However, the terminals (pins) will become rusty, or the transceiver will function abnormally if the connector becomes wet.

CAUTION: Firmly attach to the multi connector, but do not overtighten. A loose connection will allow water intrusion into the connector. An overtightened connection will damage the connector pins on the transceiver.

MB-136 BELT CLIP (for the Portable type transceiver)

◇ MB-136 contents

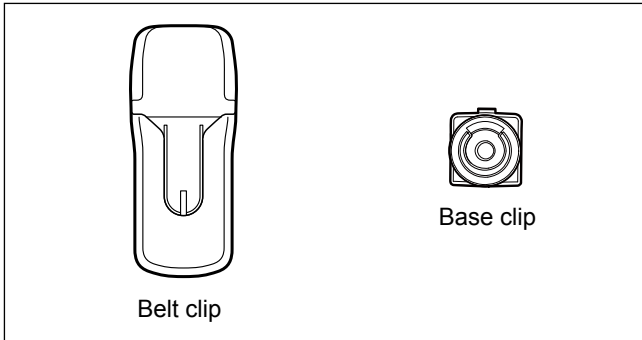

◇ Attaching

1. Detach the battery pack, if attached. (p. 1-3)
2. Slide the base clip in the direction of the arrow until the clip locks and makes a "click" sound.
3. Attach the battery pack to the transceiver. (p. 1-3)

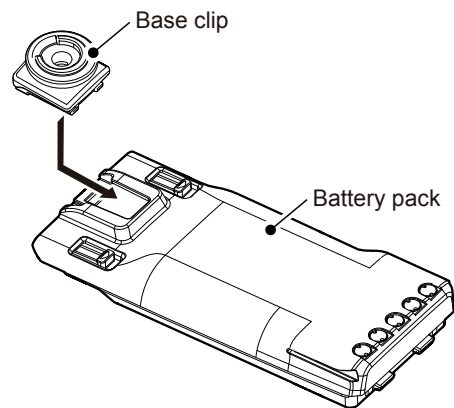

4. Clip the belt clip on your belt.
5. Insert the transceiver upsidedown into the belt clip until the base clip is fully inserted in the groove.

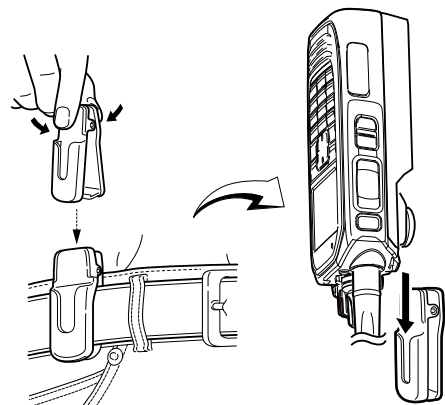

6. Once the transceiver is locked in place, it swivels, as shown to the right.

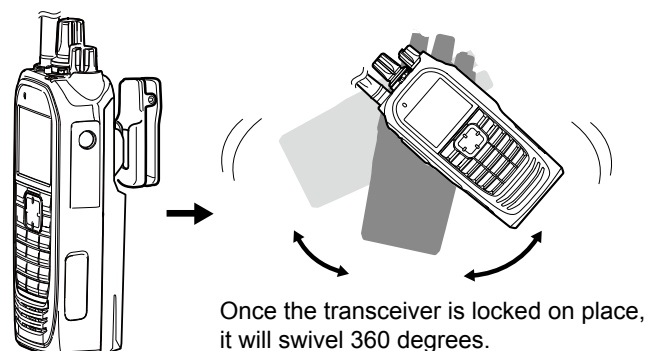

MB-136 BELT CLIP (for the Portable type transceiver) (Continued)

◇ **Detaching**

1. Turn the transceiver upsidedown in the direction of the arrow and pull it out of the belt clip.
2. Detach the battery pack. (p. 1-3)

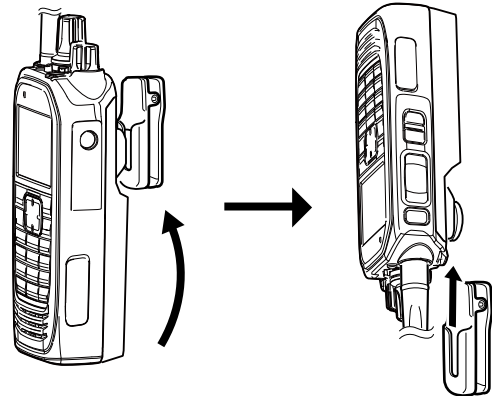

3. Pinch the tab on the base clip (1), and then slide the clip in the direction of the arrow (2).

BE CAREFUL! Don't break your fingernail.

NOTE: HOLD THE TRANSCEIVER TIGHTLY WHEN INSERTING OR REMOVING THE TRANSCEIVER FROM THE BELT CLIP. Otherwise the transceiver may not be properly attached to the holder or swivel, if the transceiver has been accidentally dropped and the base clip is scratched or damaged.

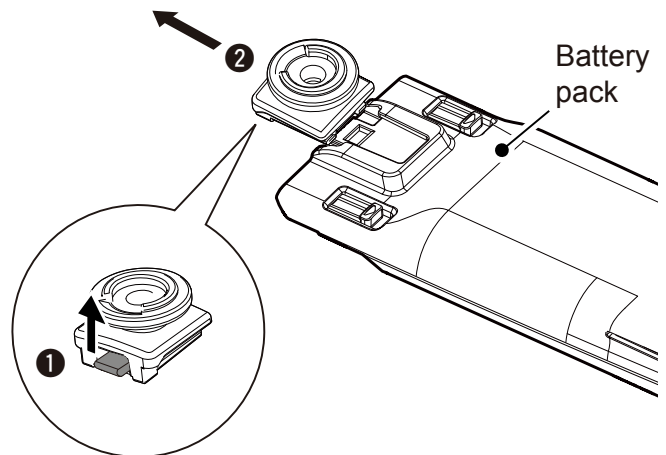

LC-184 CARRYING CASE (for the Portable type transceiver)

◇ Attaching

1. Insert the transceiver into the carrying case, as shown to the right.
2. Connect the hook and loop tape points.

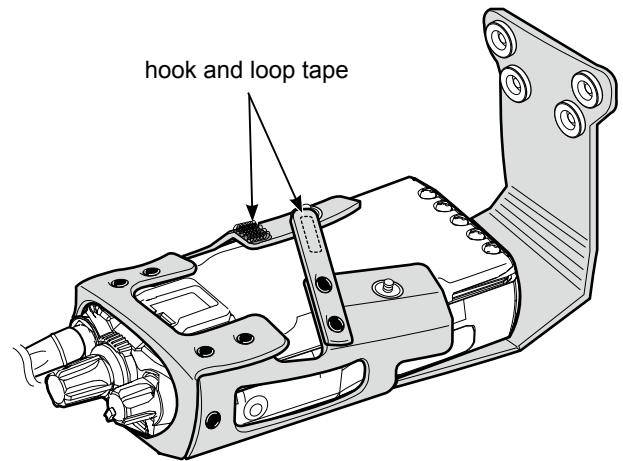

3. Adjust the snap buttons to secure the transceiver, as shown to the right.
 - BP-283: Use the lower snap buttons to secure the transceiver.
 - BP-284: Use the upper snap buttons to fasten the transceiver.

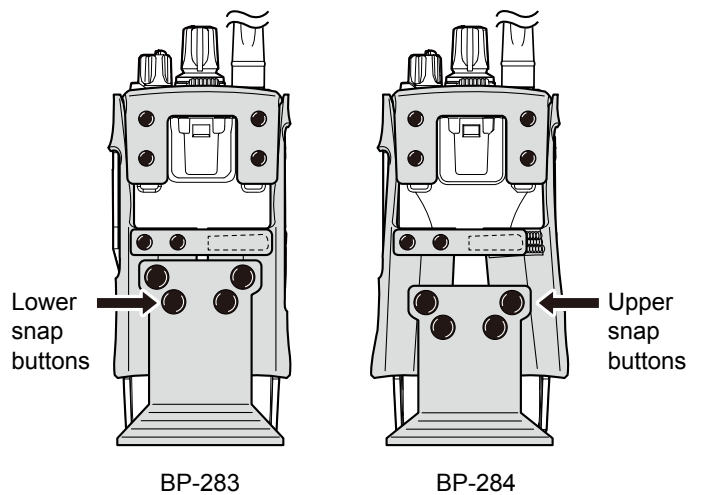

INDEX

A

Accessories	1-1
Attaching.....	1-3
Battery pack (Portable)	1-3
Belt clip (Portable).....	1-4
Flexible antenna (Portable).....	1-3
Mounting bracket (Mobile)	1-6
Adjusting audio level	3-2
Advanced operation.....	4-1
AquaQuake™ Water Draining function	4-8
Assignable keys, keypads, and Lever switch For the Portable type transceiver.....	2-11

Assignable keys, keypads, and switch For the Mobile type transceiver	2-11
---	------

APCO P25 MODE OPERATION	7-1
General	7-2
Deleting the Incoming list.....	7-13
Displaying the Incoming list	7-12
Deleting the Outgoing list.....	7-14
Displaying the Outgoing list	7-14
Receiving a call.....	7-10
Receiving a Call Alert call	7-10
Receiving a Group call.....	7-10
Receiving a Short message	7-10
Receiving an Emergency call.....	7-11
Receiving an Individual call.....	7-10
Receiving a Radio Check call	7-10
Receiving a Remote Monitor call	7-10
Receiving a Status message	7-10
Transmitting a call.....	7-3
Transmitting a Call Alert call	7-6
Transmitting a Talkgroup call	7-3
Transmitting a Short Message	7-5
Transmitting an Emergency call.....	7-9
Transmitting an Individual call.....	7-3
Transmitting a Radio Check.....	7-7
Transmitting a Remote Monitor call	7-7
Transmitting a Status message	7-4
Transmitting a Phone call	7-9

B

Backing up the data saved on the microSD card	9-7
Backlight status setting.....	12-2
Basic operation.....	3-1
Battery pack (Portable).....	1-3
Belt clip (Portable)	1-4
Bluetooth® operation.....	11-1
Bluetooth® Wireless Technology operation.....	11-2
Accepting a pairing request	11-9
Deleting a Bluetooth® device from the pairing list.....	11-12
Disconnecting from a Bluetooth® device.....	11-11
Electromagnetic Interference.....	11-2
Headset settings	11-6
Pairing with a data device.....	11-7
Pairing with a headset	11-4
Turning ON the Bluetooth® function.....	11-3
Resetting the installed Bluetooth® unit.....	11-13
The maximum number of paired devices.....	11-14

C

Call procedure	3-7
Canceling a Scan	5-3
Channel selection	3-4
Selecting a Continuous tone channel	3-5
Selecting an operating channel	3-4
Selecting an NAC channel.....	3-6
Connector cover (Portable)	1-5
Continuous tone channel.....	3-5
Control Head	6-21
Copying data from a transceiver.....	13-4

D

DTMF calls	4-2
Autodial.....	4-2
Manual Dialing	4-2

E

Emergency call.....	4-3
Transmitting	4-3
The [Emergency] key	4-3
The Lone Worker function.....	4-5
The Man Down function	4-4
The Motion Detection function	4-6
The Stationary Detection function.....	4-6
Encryption.....	7-15

F

Firmware information displaying	13-2
Flexible antenna (Portable)	1-3
Front, top and side panels For the Mobile type transceiver	2-5
Microphone connector	2-5
Transceiver types.....	2-5
For the Portable type transceiver.....	2-2
Multi-connector	2-2
Transceiver types.....	2-2
Function display For the Mobile type transceiver	2-7
For the Portable type transceiver.....	2-3

H

Headset settings.....	11-6
AF Output	11-6
Key Beep	11-6
One-touch PTT	11-6
Power Save	11-6
PTT Beep.....	11-6
HM-222 SPEAKER MICROPHONE	14-2
Attaching.....	14-2

INDEX

I	
Incoming Call log function	8-9
Incoming list	
Deleting.....	8-9
Displaying the Incoming call log	7-12, 8-9
K	
Key Lock function	3-9
Key-touch Beep level setting	12-3
L	
LC-184 CARRYING CASE.....	14-5
Attaching.....	14-5
Types	14-5
LCD Color Check.....	13-3
M	
MB-136 BELT CLIP.....	14-3
Attaching.....	14-3
Contents	14-3
Detaching.....	14-4
MDC 1200 system operation	8-2
General	8-2
Receiving a call.....	8-7
Receiving an MDC Call Alert call	8-7
Receiving an MDC Emergency call	8-8
Receiving an MDC Message call	8-7
Receiving an MDC Selective call (SelCall)	8-8
Receiving an MDC Status call	8-7
Receiving an MDC Stun call or Revive call.....	8-8
Receiving a PTT ID.....	8-7
Transmitting a call.....	8-3
Transmitting an MDC Call Alert call	8-4
Transmitting an MDC Emergency Acknowledgement	8-3
Transmitting an MDC Emergency call	8-3
Transmitting an MDC Message call	8-4
Transmitting an MDC Radio Check call	8-5
Transmitting an MDC Revive call.....	8-6
Transmitting an MDC Selective Call (SelCall)	8-6
Transmitting an MDC Status call	8-7
Transmitting an MDC Stun call	8-5
Transmitting a PTT ID	8-7
Menu items	6-3
Audio Setting	
Mic Gain.....	6-14
RX Equalizer Edit.....	6-14
RX Equalizer Effect.....	6-14
RX Noise Cancel.....	6-14
TX Equalizer Edit	6-14
TX Equalizer Effect	6-14
TX Noise Cancel.....	6-14
Menu items (continued)	
Bluetooth	
Bluetooth.....	6-16
Bluetooth Audio Setting.....	6-16
Bluetooth Auto Connect	6-16
Bluetooth Reset	6-16
BT Device Info	6-16
BT Device List.....	6-16
Key Beep (VS-3).....	6-16
One-touch PTT	6-16
P.Save (VS-3)	6-16
PTT Beep (VS-3)	6-16
Waiting Pairing.....	6-16
Channel/Scan	
Compander	6-8
C.Tone CH Select	6-8
Prio A (Rewrite)	6-8
Priority A CH.....	6-8
Priority B CH	6-8
NAC CH Select	6-8
RF Power	6-8
Scan List	6-8
Scan Start/Stop.....	6-8
Scan Tag	6-8
Scramble/Encrypt.....	6-8
Talk Around	6-8
Zone Select.....	6-8
Clock	
Clock Adjust	6-17
Clock Auto Adjust.....	6-17
Clock Display	6-17
DST	6-17
Display	
Backlight	6-18
Brightness.....	6-18
Dimmer	6-18
LCD Color Test.....	6-18
LCD Mode.....	6-18
Functions	
Ext CH Sel Mode	6-11
Hook Scan	6-11
Horn	6-11
Lone Worker	6-11
Public Address	6-11
RX Speaker	6-11
Surveillance	6-11
USB Mode Select.....	6-11
VOX	6-11
VOX Delay	6-11
VOX Gain.....	6-11
GPS	
GPS ON/OFF.....	6-12
My Position	6-12
Information	
Battery Info.....	6-20
Comment	6-20
Firmware Info.....	6-20
RSSI/BER	6-20

INDEX

Menu items (continued)	
SD Card	
Load Setting <- SD	6-15
SD Format.....	6-15
SD Information.....	6-15
SD Unmount	6-15
Software Update	6-15
Sensor	
Man down Angle	6-18
Motion Sense.....	6-18
Stationary Sense.....	6-18
Signaling/Call	
Call Menu.....	6-9
Clear Incoming.....	6-9
Clear Outgoing.....	6-9
DTMF Autodial	6-9
Group Select.....	6-9
Incoming	6-9
Individual Select.....	6-9
Message	6-9
Outgoing	6-9
Status.....	6-9
Utility	
Announce Lv	6-19
Emer Beep Lv	6-19
Key-touch Beep Lv.....	6-19
Opening Beep Lv	6-19
Ringer Lv.....	6-19
Side Tone Lv	6-19
SQL Level	6-19
System Beep Lv.....	6-19
Warning Beep Lv	6-19
Vibration	
Key Vibration.....	6-17
Opening Vibration	6-17
Vibration.....	6-17
Voice Rec	
Call Recorder	6-13
Play Call Rec	6-13
Menu screen.....	6-2
Microphone connector.....	2-5
Microphone gain level setting.....	12-6
Microphone hanger.....	1-2
microSD card.....	9-1, 9-2
Displaying the information of the microSD card.....	9-6
Backing up the data saved on the microSD card.....	9-7
Formatting the microSD card.....	9-4
microSD card's folder contents.....	9-7
Inserting the microSD card	9-3
Loading the saved data files onto a microSD card	9-5
Making a backup file on your PC.....	9-7
Removing the microSD card.....	9-3
Saving data onto the microSD card.....	9-2
Unmounting the microSD card.....	9-4
Mounting bracket (Mobile).....	1-6
Multi-connector	1-5
	N
Network Access Code (NAC).....	4-7
Selecting.....	3-8
	O
Options	14-1
HM-222 SPEAKER MICROPHONE	14-2
LC-184 CARRYING CASE.....	14-5
MB-136 BELT CLIP.....	14-3
Outgoing list	
Deleting the Outgoing list.....	7-14
Displaying the Outgoing list.....	7-14
	P
Panel description	2-1
Password entering.....	3-2
Priority channel	
Rewriting the Priority A or B channel	3-5
Selecting the Priority A or B channel.....	3-4
	R
Rear panel (for the Mobile type transceiver)	2-6
Receiving a call	3-8, 7-11, 8-7
Ringer level setting	12-4
RX Noise Cancel level setting	12-11
	S
Scan operation	5-1
Selecting a Scan list	5-4
Setting or clearing a Scan tag.....	5-5
Starting a Scan	5-2
Scrambler	4-7
Software key functions	2-2
Assignable Software key functions	
For keys and keypads.....	2-12
For the AB switch.....	2-20
Squelch level setting.....	12-5
Status indicator.....	2-9
Supplied accessories.....	1-2
	T
Transmitting a call	3-8, 7-3, 8-3
Transmitting notes	3-8
Call procedure	3-7
Turning ON the transceiver	3-2
TX Noise Cancel level setting.....	12-10

INDEX

U

User settings.....	12-1
Backlight status.....	12-2
Key-touch Beep level.....	12-3
Microphone gain level.....	12-6
Ringer level.....	12-4
Squelch level.....	12-5
TX Noise Cancel level.....	12-10
RX Noise Cancel level.....	12-11
VOX function.....	12-7
VOX Delay.....	12-8
VOX gain level.....	12-9

V

Voice recorder functions.....	10-1
Deleting a file.....	10-6
Player screen.....	10-5
Playing back a recorded audio.....	10-4
Playing back a recorded communication audio.....	10-4
Playing back the recorded file on a PC.....	10-7
Recording a communication audio.....	10-2

VOX

VOX Delay setting.....	12-8
VOX function setting.....	12-7
VOX gain level setting.....	12-9

Z

Zone selecting.....	3-3
---------------------	-----

Count on us!

